

Operating Instructions

Proline Promass O 500

HART

Coriolis flowmeter

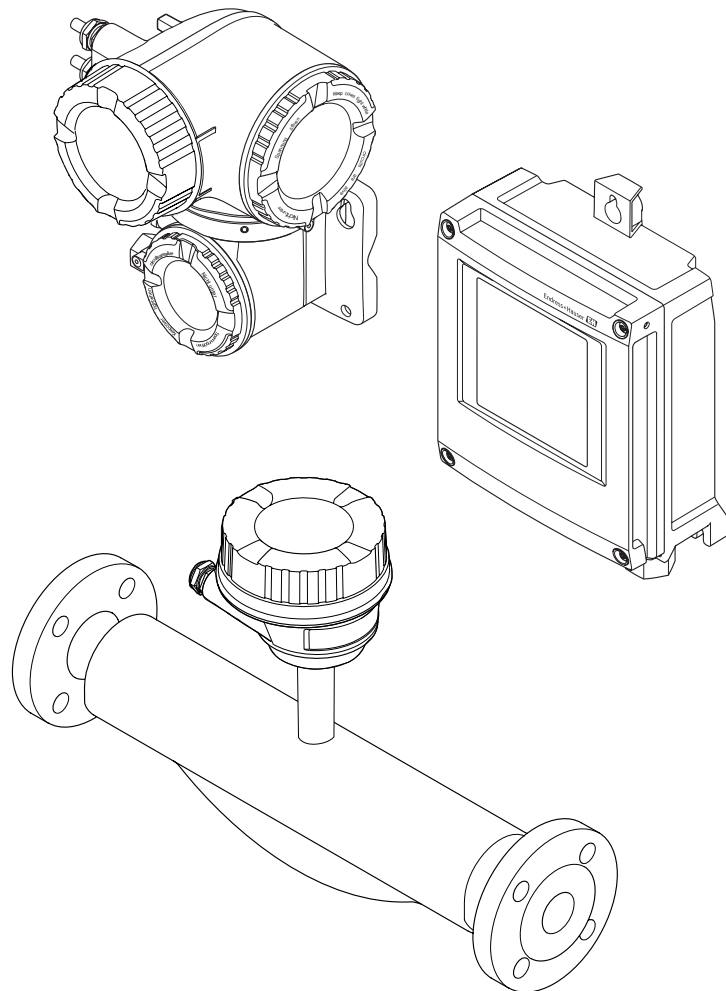

-
- Make sure the document is stored in a safe place such that it is always available when working on or with the device.
 - To avoid danger to individuals or the facility, read the "Basic safety instructions" section carefully, as well as all other safety instructions in the document that are specific to working procedures.
 - The manufacturer reserves the right to modify technical data without prior notice. Your Endress+Hauser Sales Center will supply you with current information and updates to these instructions.

Table of contents

1	Document information	6	6	Installation	22
1.1	Document function	6	6.1	Installation conditions	22
1.2	Symbols used	6	6.1.1	Mounting position	22
1.2.1	Safety symbols	6	6.1.2	Requirements from environment and process	24
1.2.2	Electrical symbols	6	6.1.3	Special mounting instructions	27
1.2.3	Communication symbols	6	6.2	Mounting the measuring device	30
1.2.4	Tool symbols	7	6.2.1	Required tools	30
1.2.5	Symbols for certain types of information	7	6.2.2	Preparing the measuring device	30
1.2.6	Symbols in graphics	7	6.2.3	Mounting the measuring device	30
1.3	Documentation	8	6.2.4	Mounting the transmitter housing: Proline 500 – digital	31
1.3.1	Standard documentation	8	6.2.5	Mounting the transmitter housing: Proline 500	32
1.3.2	Supplementary device-dependent documentation	8	6.2.6	Turning the transmitter housing: Proline 500	33
1.4	Registered trademarks	9	6.2.7	Turning the display module: Proline 500	34
2	Basic safety instructions	10	6.3	Post-installation check	35
2.1	Requirements for personnel	10	7	Electrical connection	36
2.2	Designated use	10	7.1	Connection conditions	36
2.3	Workplace safety	11	7.1.1	Required tools	36
2.4	Operational safety	11	7.1.2	Requirements for connecting cable	36
2.5	Product safety	11	7.1.3	Terminal assignment	39
2.6	IT security	12	7.1.4	Preparing the measuring device	39
2.7	Device-specific IT security	12	7.2	Connecting the measuring device: Proline 500 – digital	41
2.7.1	Protecting access via hardware write protection	12	7.2.1	Connecting the connecting cable	41
2.7.2	Protecting access via a password	12	7.2.2	Connecting the signal cable and the supply voltage cable	46
2.7.3	Access via fieldbus	13	7.3	Connecting the measuring device: Proline 500	48
2.7.4	Access via Web server	13	7.3.1	Connecting the connecting cable	48
3	Product description	14	7.3.2	Connecting the signal cable and the supply voltage cable	52
3.1	Product design	14	7.4	Ensure potential equalization	54
3.1.1	Proline 500 – digital	14	7.4.1	Requirements	54
3.1.2	Proline 500	15	7.5	Special connection instructions	54
4	Incoming acceptance and product identification	16	7.5.1	Connection examples	54
4.1	Incoming acceptance	16	7.6	Ensuring the degree of protection	58
4.2	Product identification	17	7.7	Post-connection check	59
4.2.1	Transmitter nameplate	17	8	Operation options	60
4.2.2	Sensor nameplate	19	8.1	Overview of operation options	60
4.2.3	Symbols on measuring device	20	8.2	Structure and function of the operating menu	61
5	Storage and transport	21	8.2.1	Structure of the operating menu	61
5.1	Storage conditions	21	8.2.2	Operating philosophy	62
5.2	Transporting the product	21	8.3	Access to the operating menu via the local display	63
5.2.1	Measuring devices without lifting lugs	21	8.3.1	Operational display	63
5.2.2	Measuring devices with lifting lugs	22	8.3.2	Navigation view	65
5.2.3	Transporting with a fork lift	22	8.3.3	Editing view	67
5.3	Packaging disposal	22			

8.3.4	Operating elements	68	10.4.12	Configuring the low flow cut off	119
8.3.5	Opening the context menu	69	10.4.13	Configuring the partial filled pipe detection	120
8.3.6	Navigating and selecting from list . . .	71	10.5	Advanced settings	121
8.3.7	Calling the parameter directly	71	10.5.1	Using the parameter to enter the access code	122
8.3.8	Calling up help text	72	10.5.2	Calculated values	122
8.3.9	Changing the parameters	73	10.5.3	Carrying out a sensor adjustment . . .	123
8.3.10	User roles and related access authorization	74	10.5.4	Configuring the totalizer	124
8.3.11	Disabling write protection via access code	74	10.5.5	Carrying out additional display configurations	126
8.3.12	Enabling and disabling the keypad lock	74	10.5.6	WLAN configuration	129
8.4	Access to the operating menu via the Web browser	75	10.5.7	Configuration management	130
8.4.1	Function range	75	10.5.8	Using parameters for device administration	132
8.4.2	Prerequisites	75	10.6	Simulation	133
8.4.3	Establishing a connection	77	10.7	Protecting settings from unauthorized access	136
8.4.4	Logging on	78	10.7.1	Write protection via access code . . .	136
8.4.5	User interface	79	10.7.2	Write protection via write protection switch	138
8.4.6	Disabling the Web server	80	11	Operation	140
8.4.7	Logging out	80	11.1	Reading the device locking status	140
8.5	Access to the operating menu via the operating tool	80	11.2	Adjusting the operating language	140
8.5.1	Connecting the operating tool	81	11.3	Configuring the display	140
8.5.2	Field Xpert SFX350, SFX370	84	11.4	Reading measured values	140
8.5.3	FieldCare	84	11.4.1	"Measured variables" submenu	141
8.5.4	DeviceCare	85	11.4.2	"Totalizer" submenu	142
8.5.5	AMS Device Manager	86	11.4.3	"Input values" submenu	143
8.5.6	SIMATIC PDM	86	11.4.4	Output values	144
8.5.7	Field Communicator 475	86	11.5	Adapting the measuring device to the process conditions	147
9	System integration	87	11.6	Performing a totalizer reset	147
9.1	Overview of device description files	87	11.6.1	Function scope of the "Control Totalizer" parameter	148
9.1.1	Current version data for the device . . .	87	11.6.2	Function scope of the "Reset all totalizers" parameter	148
9.1.2	Operating tools	87	11.7	Showing data logging	148
9.2	Measured variables via HART protocol	87	12	Diagnostics and troubleshooting ..	151
9.3	Other settings	89	12.1	General troubleshooting	151
9.3.1	Burst mode functionality in accordance with HART 7 Specification	89	12.2	Diagnostic information via light emitting diodes	153
10	Commissioning	92	12.2.1	Transmitter	153
10.1	Function check	92	12.2.2	Sensor connection housing	155
10.2	Switching on the measuring device	92	12.3	Diagnostic information on local display	157
10.3	Setting the operating language	92	12.3.1	Diagnostic message	157
10.4	Configuring the measuring device	92	12.3.2	Calling up remedial measures	159
10.4.1	Defining the tag name	94	12.4	Diagnostic information in the Web browser .	159
10.4.2	Setting the system units	94	12.4.1	Diagnostic options	159
10.4.3	Selecting and setting the medium . . .	97	12.4.2	Calling up remedy information	160
10.4.4	Displaying the I/O configuration	98	12.5	Diagnostic information in DeviceCare or FieldCare	161
10.4.5	Configuring the current input	99	12.5.1	Diagnostic options	161
10.4.6	Configuring the status input	100	12.5.2	Calling up remedy information	162
10.4.7	Configuring the current output	101	12.6	Adapting the diagnostic information	162
10.4.8	Configuring the pulse/frequency/ switch output	104	12.6.1	Adapting the diagnostic behavior . . .	162
10.4.9	Configuring the relay output	113			
10.4.10	Configuring the double pulse output	115			
10.4.11	Configuring the local display	116			

12.6.2	Adapting the status signal	162
12.7	Overview of diagnostic information	163
12.8	Pending diagnostic events	167
12.9	Diagnostic list	168
12.10	Event logbook	168
12.10.1	Event history	168
12.10.2	Filtering the event logbook	169
12.10.3	Overview of information events	169
12.11	Resetting the measuring device	171
12.11.1	Function scope of the "Device reset" parameter	171
12.12	Device information	171
12.13	Firmware history	173
13	Maintenance	174
13.1	Maintenance tasks	174
13.1.1	Exterior cleaning	174
13.2	Measuring and test equipment	174
13.3	Endress+Hauser services	174
14	Repairs	175
14.1	General notes	175
14.1.1	Repair and conversion concept	175
14.1.2	Notes for repair and conversion	175
14.2	Spare parts	175
14.3	Endress+Hauser services	175
14.4	Return	175
14.5	Disposal	176
14.5.1	Removing the measuring device	176
14.5.2	Disposing of the measuring device	176
15	Accessories	177
15.1	Device-specific accessories	177
15.1.1	For the transmitter	177
15.1.2	For the sensor	178
15.2	Communication-specific accessories	178
15.3	Service-specific accessories	178
15.4	System components	179
16	Technical data	180
16.1	Application	180
16.2	Function and system design	180
16.3	Input	181
16.4	Output	184
16.5	Power supply	189
16.6	Performance characteristics	190
16.7	Installation	194
16.8	Environment	194
16.9	Process	195
16.10	Mechanical construction	197
16.11	Operability	200
16.12	Certificates and approvals	203
16.13	Application packages	206
16.14	Accessories	207
16.15	Supplementary documentation	207

Index	209
------------------------	------------





1 Document information

1.1 Document function







These Operating Instructions contain all the information that is required in various phases of the life cycle of the device: from product identification, incoming acceptance and storage, to mounting, connection, operation and commissioning through to troubleshooting, maintenance and disposal.

1.2 Symbols used



1.2.1 Safety symbols



Symbol	Meaning
	DANGER! This symbol alerts you to a dangerous situation. Failure to avoid this situation will result in serious or fatal injury.
	WARNING! This symbol alerts you to a dangerous situation. Failure to avoid this situation can result in serious or fatal injury.
	CAUTION! This symbol alerts you to a dangerous situation. Failure to avoid this situation can result in minor or medium injury.
	NOTE! This symbol contains information on procedures and other facts which do not result in personal injury.

1.2.2 Electrical symbols



Symbol	Meaning
	Direct current
	Alternating current
	Direct current and alternating current
	Ground connection A grounded terminal which, as far as the operator is concerned, is grounded via a grounding system.
	Protective ground connection A terminal which must be connected to ground prior to establishing any other connections.
	Equipotential connection A connection that has to be connected to the plant grounding system: This may be a potential equalization line or a star grounding system depending on national or company codes of practice.

1.2.3 Communication symbols













Symbol	Meaning
	Wireless Local Area Network (WLAN) Communication via a wireless, local network.
	Bluetooth Wireless data transmission between devices over a short distance.

Symbol	Meaning
	LED Light emitting diode is off.
	LED Light emitting diode is on.
	LED Light emitting diode is flashing.



1.2.4 Tool symbols



Symbol	Meaning
	Torx screwdriver
	Phillips head screwdriver
	Open-ended wrench

1.2.5 Symbols for certain types of information

Symbol	Meaning
	Permitted Procedures, processes or actions that are permitted.
	Preferred Procedures, processes or actions that are preferred.
	Forbidden Procedures, processes or actions that are forbidden.
	Tip Indicates additional information.
	Reference to documentation
	Reference to page
	Reference to graphic
	Notice or individual step to be observed
	Series of steps
	Result of a step
	Help in the event of a problem
	Visual inspection

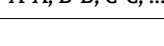
1.2.6 Symbols in graphics



Symbol	Meaning
	Item numbers
	Series of steps
	Views
	Sections

Symbol	Meaning
	Hazardous area
	Safe area (non-hazardous area)
	Flow direction

1.3 Documentation

 For an overview of the scope of the associated Technical Documentation, refer to the following:

- The *W@M Device Viewer* : Enter the serial number from the nameplate (www.endress.com/deviceviewer)
- The *Endress+Hauser Operations App*: Enter the serial number from the nameplate or scan the 2-D matrix code (QR code) on the nameplate.

 For a detailed list of the individual documents along with the documentation code
→  207

1.3.1 Standard documentation

Document type	Purpose and content of the document
Technical Information	Planning aid for your device The document contains all the technical data on the device and provides an overview of the accessories and other products that can be ordered for the device.
Sensor Brief Operating Instructions	Guides you quickly to the 1st measured value - Part 1 The Sensor Brief Operating Instructions are aimed at specialists with responsibility for installing the measuring device. <ul style="list-style-type: none"> ▪ Incoming acceptance and product identification ▪ Storage and transport ▪ Installation
Transmitter Brief Operating Instructions	Guides you quickly to the 1st measured value - Part 2 The Transmitter Brief Operating Instructions are aimed at specialists with responsibility for commissioning, configuring and parameterizing the measuring device (until the first measured value). <ul style="list-style-type: none"> ▪ Product description ▪ Installation ▪ Electrical connection ▪ Operation options ▪ System integration ▪ Commissioning ▪ Diagnostic information
Description of Device Parameters	Reference for your parameters The document provides a detailed explanation of each individual parameter in the Expert operating menu. The description is aimed at those who work with the device over the entire life cycle and perform specific configurations.

1.3.2 Supplementary device-dependent documentation

Additional documents are supplied depending on the device version ordered: Always comply strictly with the instructions in the supplementary documentation. The supplementary documentation is an integral part of the device documentation.

1.4 Registered trademarks

HART®

Registered trademark of the FieldComm Group, Austin, Texas, USA

TRI-CLAMP®

Registered trademark of Ladish & Co., Inc., Kenosha, USA

Applicator®, FieldCare®, DeviceCare®, Field Xpert™, HistoROM®, Heartbeat Technology™

Registered or registration-pending trademarks of the Endress+Hauser Group

2 Basic safety instructions

2.1 Requirements for personnel

The personnel for installation, commissioning, diagnostics and maintenance must fulfill the following requirements:

- ▶ Trained, qualified specialists must have a relevant qualification for this specific function and task.
- ▶ Are authorized by the plant owner/operator.
- ▶ Are familiar with federal/national regulations.
- ▶ Before starting work, read and understand the instructions in the manual and supplementary documentation as well as the certificates (depending on the application).
- ▶ Follow instructions and comply with basic conditions.

The operating personnel must fulfill the following requirements:

- ▶ Are instructed and authorized according to the requirements of the task by the facility's owner-operator.
- ▶ Follow the instructions in this manual.

2.2 Designated use

Application and media

The measuring device described in these Instructions is intended only for flow measurement of liquids and gases.

Depending on the version ordered, the measuring device can also measure potentially explosive, flammable, poisonous and oxidizing media.

Measuring devices for use in hazardous areas, in hygienic applications or where there is an increased risk due to process pressure, are labeled accordingly on the nameplate.

To ensure that the measuring device remains in proper condition for the operation time:

- ▶ Only use the measuring device in full compliance with the data on the nameplate and the general conditions listed in the Operating Instructions and supplementary documentation.
- ▶ Based on the nameplate, check whether the ordered device is permitted for the intended use in the hazardous area (e.g. explosion protection, pressure vessel safety).
- ▶ Use the measuring device only for media to which the process-wetted materials are sufficiently resistant.
- ▶ If the measuring device is not operated at atmospheric temperature, compliance with the relevant basic conditions specified in the associated device documentation is absolutely essential: "Documentation" section. →  8.
- ▶ Protect the measuring device permanently against corrosion from environmental influences.

Incorrect use

Non-designated use can compromise safety. The manufacturer is not liable for damage caused by improper or non-designated use.

WARNING

Danger of breakage due to corrosive or abrasive fluids!

- ▶ Verify the compatibility of the process fluid with the sensor material.
- ▶ Ensure the resistance of all fluid-wetted materials in the process.
- ▶ Keep within the specified pressure and temperature range.

NOTICE**Verification for borderline cases:**

- ▶ For special fluids and fluids for cleaning, Endress+Hauser is glad to provide assistance in verifying the corrosion resistance of fluid-wetted materials, but does not accept any warranty or liability as minute changes in the temperature, concentration or level of contamination in the process can alter the corrosion resistance properties.

Residual risks**⚠ WARNING****The electronics and the medium may cause the surfaces to heat up. This presents a burn hazard!**

- ▶ For elevated fluid temperatures, ensure protection against contact to prevent burns.

⚠ WARNING**Danger of housing breaking due to measuring tube breakage!**

- ▶ In the event of a measuring tube breakage for a device version without rupture disk it is possible for the pressure loading capacity of the sensor housing to be exceeded. This can lead to rupture or failure of the sensor housing.

2.3 Workplace safety

For work on and with the device:

- ▶ Wear the required personal protective equipment according to federal/national regulations.

For welding work on the piping:

- ▶ Do not ground the welding unit via the measuring device.

If working on and with the device with wet hands:

- ▶ Due to the increased risk of electric shock, gloves must be worn.

2.4 Operational safety

Risk of injury.

- ▶ Operate the device in proper technical condition and fail-safe condition only.
- ▶ The operator is responsible for interference-free operation of the device.

Conversions to the device

Unauthorized modifications to the device are not permitted and can lead to unforeseeable dangers.

- ▶ If, despite this, modifications are required, consult with Endress+Hauser.

Repair

To ensure continued operational safety and reliability,

- ▶ Carry out repairs on the device only if they are expressly permitted.
- ▶ Observe federal/national regulations pertaining to repair of an electrical device.
- ▶ Use original spare parts and accessories from Endress+Hauser only.

2.5 Product safety

This measuring device is designed in accordance with good engineering practice to meet state-of-the-art safety requirements, has been tested, and left the factory in a condition in which it is safe to operate.

It meets general safety standards and legal requirements. It also complies with the EU directives listed in the device-specific EU Declaration of Conformity. Endress+Hauser confirms this by affixing the CE mark to the device.

2.6 IT security

We only provide a warranty if the device is installed and used as described in the Operating Instructions. The device is equipped with security mechanisms to protect it against any inadvertent changes to the device settings.

IT security measures in line with operators' security standards and designed to provide additional protection for the device and device data transfer must be implemented by the operators themselves.

2.7 Device-specific IT security

The device offers a range of specific functions to support protective measures on the operator's side. These functions can be configured by the user and guarantee greater in-operation safety if used correctly. An overview of the most important functions is provided in the following section.

2.7.1 Protecting access via hardware write protection

Write access to the device parameters via the local display, Web browser or operating tool (e.g. FieldCare, DeviceCare) can be disabled via a write protection switch (DIP switch on the motherboard). When hardware write protection is enabled, only read access to the parameters is possible.

Hardware write protection is disabled when the device is delivered →  138.

2.7.2 Protecting access via a password

Different passwords are available to protect write access to the device parameters or access to the device via the WLAN interface.

- **User-specific access code**
Protect write access to the device parameters via the local display, Web browser or operating tool (e.g. FieldCare, DeviceCare). Is equivalent to hardware write protection in terms of functionality.
- **WLAN passphrase**
The network key protects a connection between an operating unit (e.g. notebook or tablet) and the device via the WLAN interface which can be ordered as an option.

User-specific access code

Write access to the device parameters via the local display, Web browser or operating tool (e.g. FieldCare, DeviceCare) can be protected by the modifiable, user-specific access code (→  136).

When the device is delivered, the device does not have an access code and is equivalent to 0000 (open).

WLAN passphrase

A connection between an operating unit (e.g. notebook or tablet) and the device via the WLAN interface (→  82) which can be ordered as an option is protected by the network key. The WLAN authentication of the network key complies with the IEEE 802.11 standard.

When the device is delivered, the network key is pre-defined depending on the device. It can be changed via the **WLAN settings** submenu in the **WLAN passphrase** parameter →  129.

General notes on the use of passwords

- The access code and network key supplied with the device should be changed during commissioning.
- Follow the general rules for generating a secure password when defining and managing the access code or network key.
- The user is responsible for the management and careful handling of the access code and network key.

2.7.3 Access via fieldbus

When communicating via fieldbus, access to the device parameters can be restricted to "Read only" access. The option can be changed in the **Fieldbus writing access** parameter.

This does not affect cyclic measured value transmission to the higher-order system, which is always guaranteed.

 Additional information: "Description of Device Parameters" document pertaining to the device →  207.

2.7.4 Access via Web server

The device can be operated and configured via a Web browser with the integrated Web server (→  75). The connection is via the service interface (CDI-RJ45) or the WLAN interface.

The Web server is enabled when the device is delivered. The Web server can be disabled if necessary (e.g. after commissioning) via the **Web server functionality** parameter.

The device and status information can be hidden on the login page. This prevents unauthorized access to the information.

 Additional information: "Description of Device Parameters" document pertaining to the device →  207.

3 Product description

The measuring system consists of a transmitter and a sensor. The transmitter and sensor are mounted in physically separate locations. They are interconnected by one connecting cable(s).

3.1 Product design

Two versions of the transmitter are available.

3.1.1 Proline 500 – digital

Signal transmission: digital

Order code for "Integrated ISEM electronics", option **A** "Sensor"

For use in applications not required to meet special requirements due to ambient or operating conditions.

As the electronics are located in the sensor, the device is ideal:

For simple transmitter replacement.

- A standard cable can be used as the connecting cable.
- Not sensitive to external EMC interference.

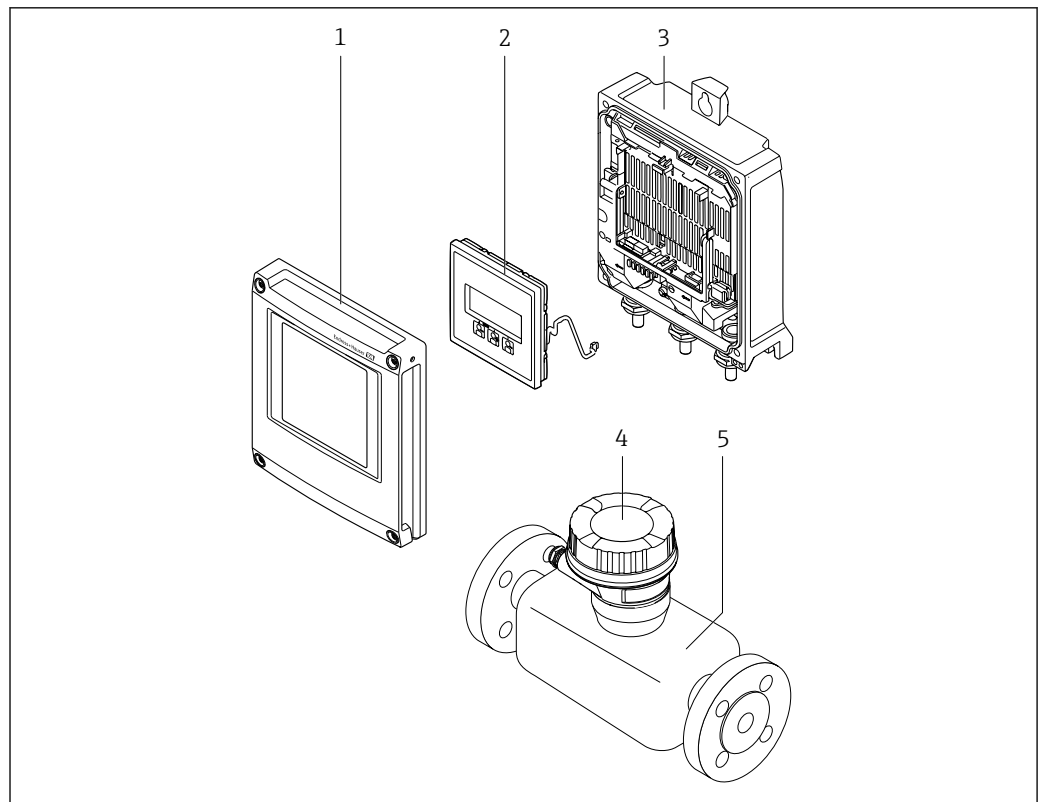

A0029593

1 Important components of a measuring device

- 1 Electronics compartment cover
- 2 Display module
- 3 Transmitter housing
- 4 Sensor connection housing with integrated ISEM electronics: connecting cable connection
- 5 Sensor

3.1.2 Proline 500

Signal transmission: analog

Order code for "Integrated ISEM electronics", option **B** "Transmitter"

For use in applications required to meet special requirements due to ambient or operating conditions.

As the electronics are located in the transmitter, the device is ideal in the event of:

- Strong vibrations at the sensor.
- Sensor operation in underground installations.
- Permanent sensor immersion in water.

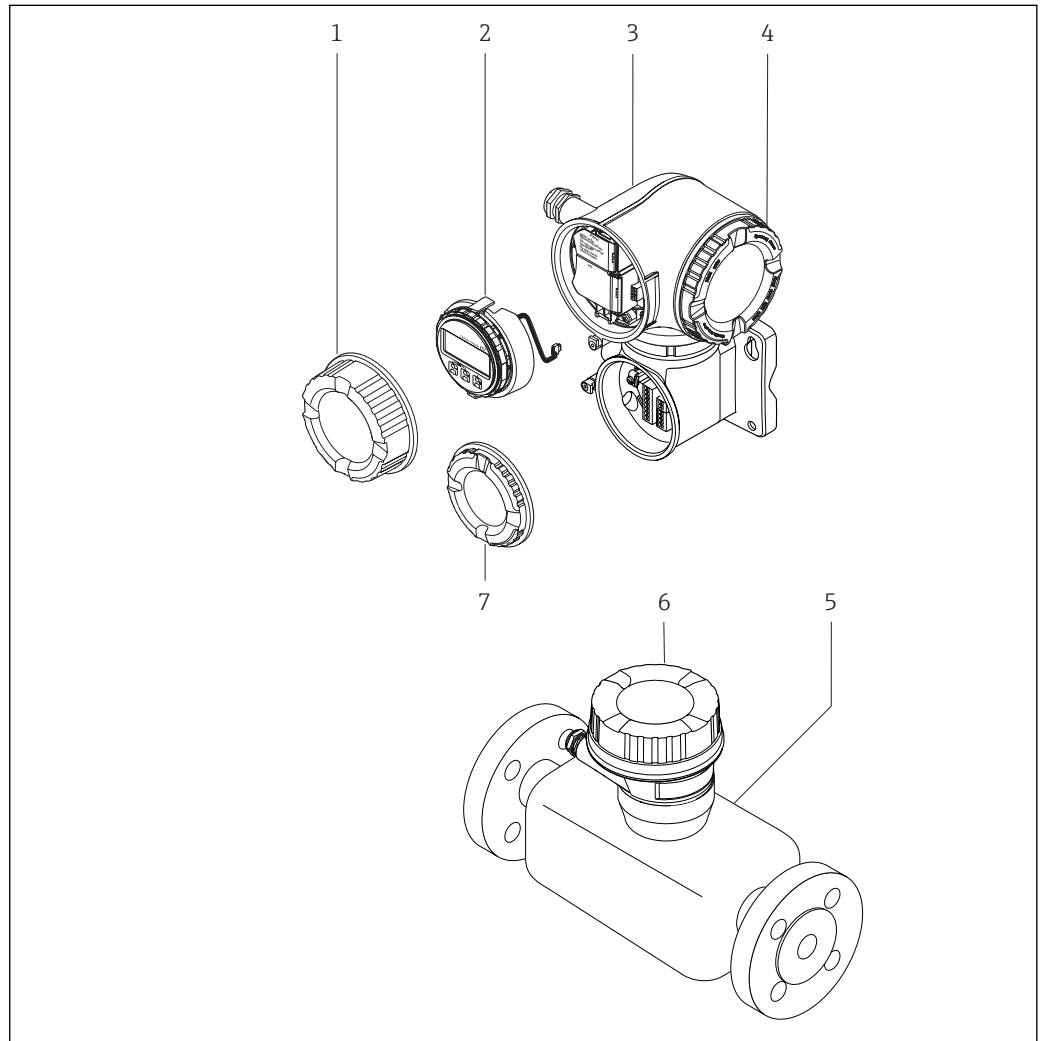

A0029589

2 Important components of a measuring device

- 1 Connection compartment cover
- 2 Display module
- 3 Transmitter housing with integrated ISEM electronics
- 4 Electronics compartment cover
- 5 Sensor
- 6 Sensor connection housing: connecting cable connection
- 7 Connection compartment cover: connecting cable connection

4 Incoming acceptance and product identification

4.1 Incoming acceptance



A0028673

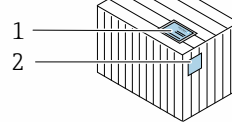
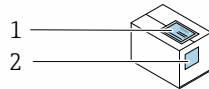

Are the order codes on the delivery note (1) and the product sticker (2) identical?

A0029314

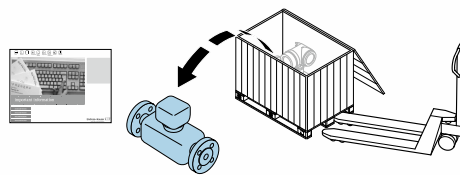

A0029315



A0028673

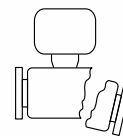
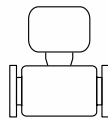

Are the goods undamaged?

A0029316



A0028673

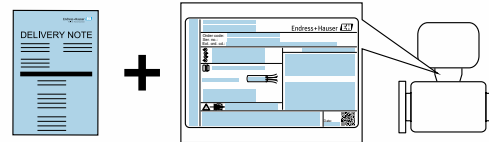

Do the nameplate data match the ordering information on the delivery note?

A0029317



A0028673

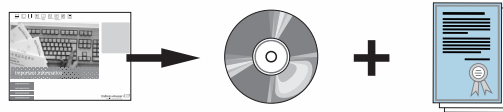

Is the CD-ROM with the Technical Documentation (depends on device version) and documents present?

A0029318

- i** ■ If one of the conditions is not satisfied, contact your Endress+Hauser Sales Center.
- Depending on the device version, the CD-ROM might not be part of the delivery! The Technical Documentation is available via the Internet or via the *Endress+Hauser Operations App*, see the "Product identification" section → 17.

4.2 Product identification

The following options are available for identification of the measuring device:

- Nameplate specifications
- Order code with breakdown of the device features on the delivery note
- Enter serial numbers from nameplates in *W@M Device Viewer* (www.endress.com/deviceviewer): All information about the measuring device is displayed.
- Enter the serial number from the nameplates into the *Endress+Hauser Operations App* or scan the 2-D matrix code (QR code) on the nameplate with the *Endress+Hauser Operations App*: all the information for the measuring device is displayed.

For an overview of the scope of the associated Technical Documentation, refer to the following:

- The chapters "Additional standard documentation on the device" → 8 and "Supplementary device-dependent documentation" → 8
- The *W@M Device Viewer*: Enter the serial number from the nameplate (www.endress.com/deviceviewer)
- The *Endress+Hauser Operations App*: Enter the serial number from the nameplate or scan the 2-D matrix code (QR code) on the nameplate.

4.2.1 Transmitter nameplate

Proline 500 – digital

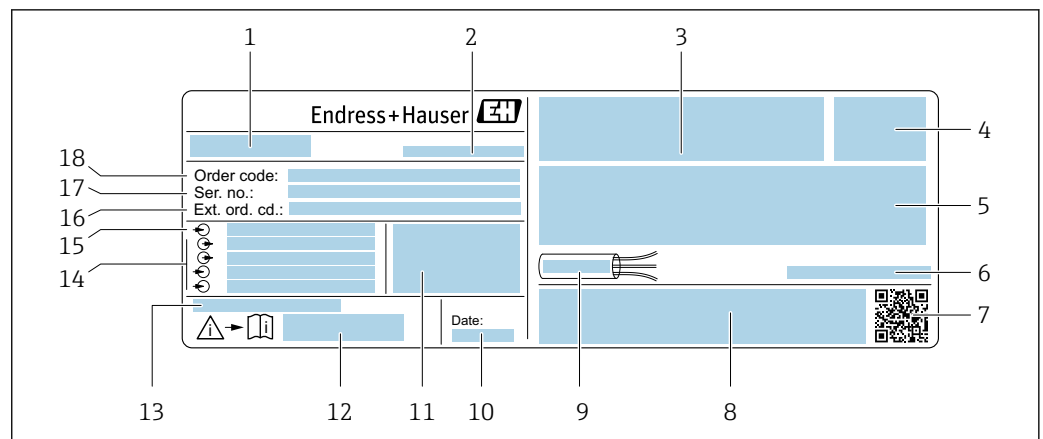

3 Example of a transmitter nameplate

- 1 Name of the transmitter
- 2 Manufacturing location
- 3 Space for approvals: use in hazardous areas
- 4 Degree of protection
- 5 Electrical connection data: available inputs and outputs
- 6 Permitted ambient temperature (T_a)
- 7 2-D matrix code
- 8 Space for approvals and certificates: e.g. CE mark, C-Tick
- 9 Permitted temperature range for cable
- 10 Manufacturing date: year-month
- 11 Firmware version (FW) and device revision (Dev.Rev.) from the factory
- 12 Document number of safety-related supplementary documentation
- 13 Space for additional information in the case of special products
- 14 Available inputs and outputs, supply voltage
- 15 Electrical connection data: supply voltage
- 16 Extended order code (Ext. ord. cd.)
- 17 Serial number (ser. no.)
- 18 Order code

Proline 500

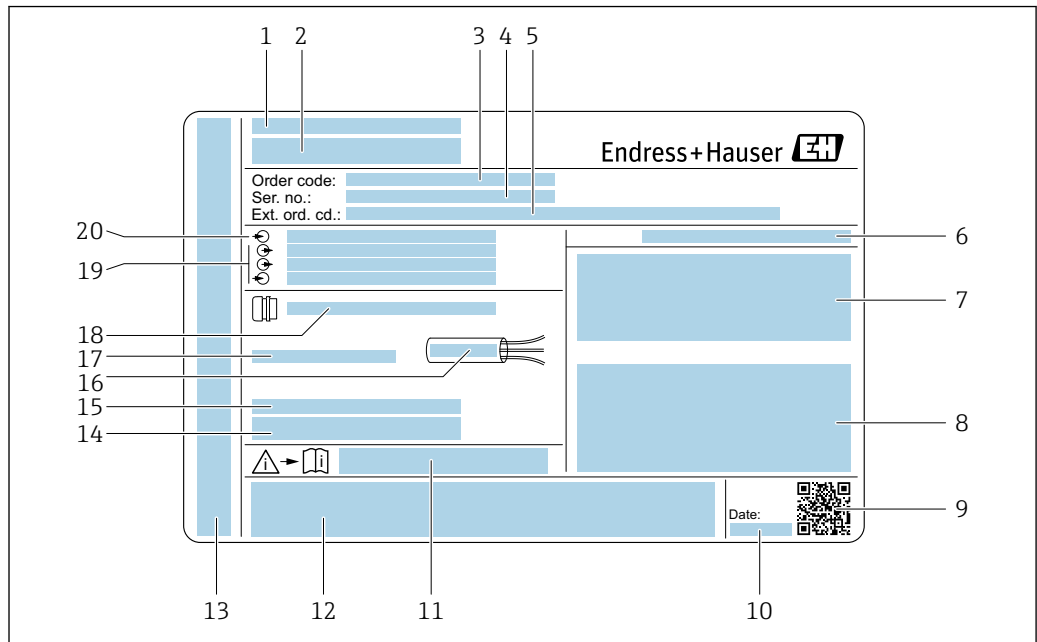

A0029192

4 Example of a transmitter nameplate

- 1 Manufacturing location
- 2 Name of the transmitter
- 3 Order code
- 4 Serial number (ser. no.)
- 5 Extended order code (Ext. ord. cd.)
- 6 Degree of protection
- 7 Space for approvals: use in hazardous areas
- 8 Electrical connection data: available inputs and outputs
- 9 2-D matrix code
- 10 Manufacturing date: year-month
- 11 Document number of safety-related supplementary documentation
- 12 Space for approvals and certificates: e.g. CE mark, C-Tick
- 13 Space for degree of protection of connection and electronics compartment when used in hazardous areas
- 14 Firmware version (FW) and device revision (Dev.Rev.) from the factory
- 15 Space for additional information in the case of special products
- 16 Permitted temperature range for cable
- 17 Permitted ambient temperature (T_a)
- 18 Information on cable gland
- 19 Available inputs and outputs, supply voltage
- 20 Electrical connection data: supply voltage

4.2.2 Sensor nameplate

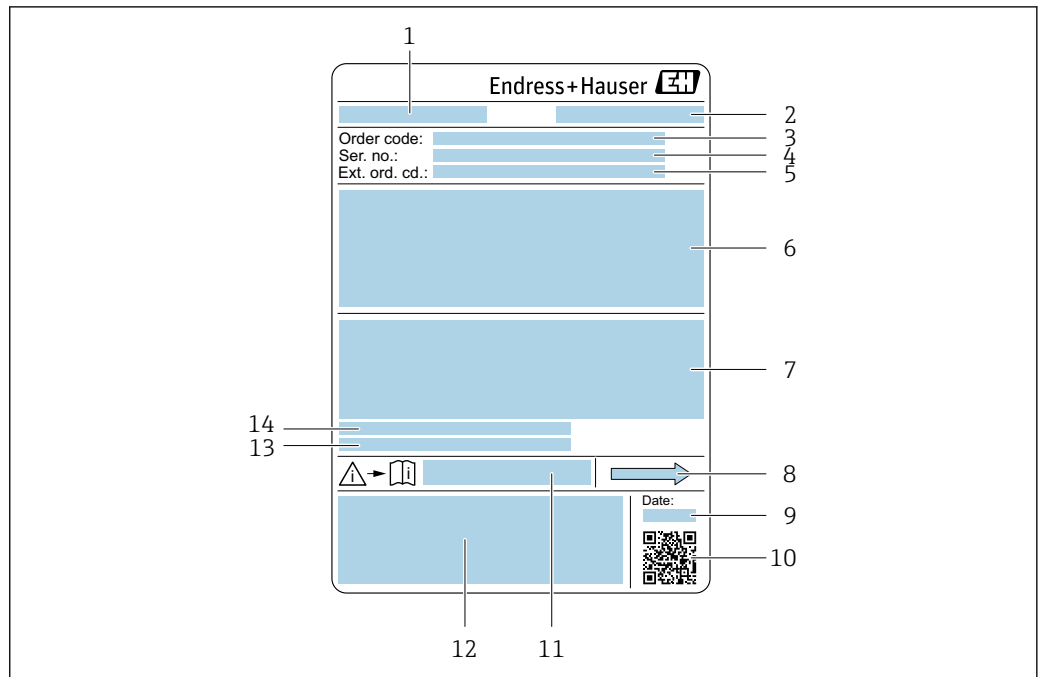

A0029199

5 Example of a sensor nameplate

- 1 Name of the sensor
- 2 Manufacturing location
- 3 Order code
- 4 Serial number (ser. no.)
- 5 Extended order code (Ext. ord. cd.)
- 6 Nominal diameter of the sensor; flange nominal diameter/nominal pressure; sensor test pressure; medium temperature range; material of measuring tube and manifold; sensor-specific information: e.g. pressure range of secondary containment, wide-range density specification (special density calibration)
- 7 Approval information for explosion protection, Pressure Equipment Directive and degree of protection
- 8 Flow direction
- 9 Manufacturing date: year-month
- 10 2-D matrix code
- 11 Document number of safety-related supplementary documentation
- 12 CE mark, C-Tick
- 13 Surface roughness
- 14 Permitted ambient temperature (T_a)



Order code

The measuring device is reordered using the order code.

Extended order code

- The device type (product root) and basic specifications (mandatory features) are always listed.
- Of the optional specifications (optional features), only the safety and approval-related specifications are listed (e.g. LA). If other optional specifications are also ordered, these are indicated collectively using the # placeholder symbol (e.g. #LA#).
- If the ordered optional specifications do not include any safety and approval-related specifications, they are indicated by the + placeholder symbol (e.g. XXXXXX-ABCDE+).

4.2.3 Symbols on measuring device

Symbol	Meaning
	WARNING! This symbol alerts you to a dangerous situation. Failure to avoid this situation can result in serious or fatal injury.
	Reference to documentation Refers to the corresponding device documentation.
	Protective ground connection A terminal which must be connected to ground prior to establishing any other connections.

5 Storage and transport

5.1 Storage conditions

Observe the following notes for storage:

- Store in the original packaging to ensure protection from shock.
- Do not remove protective covers or protective caps installed on process connections. They prevent mechanical damage to the sealing surfaces and contamination in the measuring tube.
- Protect from direct sunlight to avoid unacceptably high surface temperatures.
- Store in a dry and dust-free place.
- Do not store outdoors.

Storage temperature: -50 to $+80$ °C (-58 to $+176$ °F),

5.2 Transporting the product

Transport the measuring device to the measuring point in the original packaging.

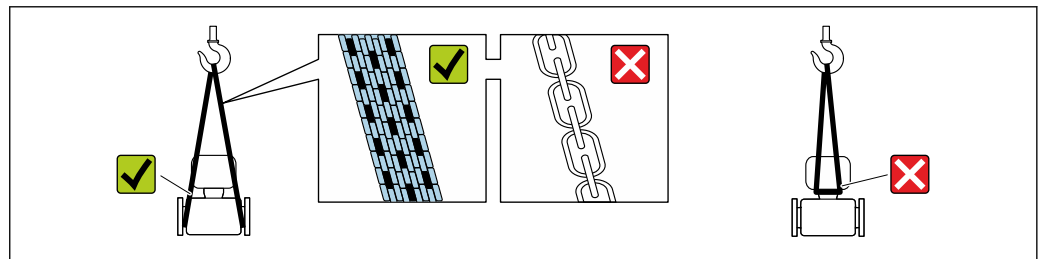

A0029252

- i** Do not remove protective covers or caps installed on process connections. They prevent mechanical damage to the sealing surfaces and contamination in the measuring tube.

5.2.1 Measuring devices without lifting lugs

⚠ WARNING

Center of gravity of the measuring device is higher than the suspension points of the webbing slings.

Risk of injury if the measuring device slips.

- ▶ Secure the measuring device against slipping or turning.
- ▶ Observe the weight specified on the packaging (stick-on label).

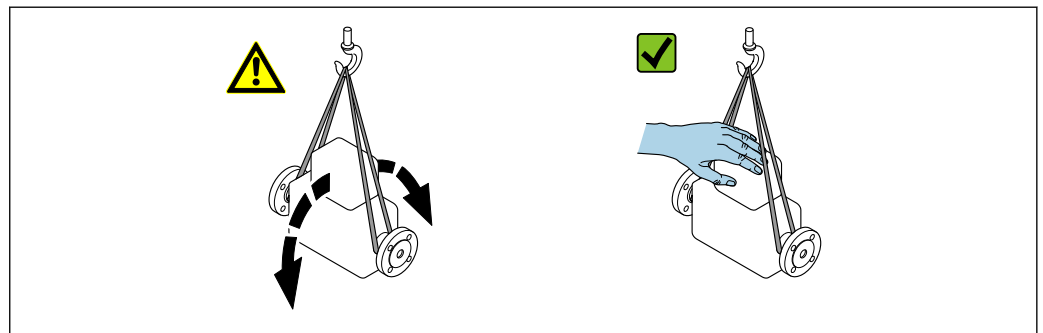

A0029214

5.2.2 Measuring devices with lifting lugs

⚠ CAUTION

Special transportation instructions for devices with lifting lugs

- ▶ Only use the lifting lugs fitted on the device or flanges to transport the device.
- ▶ The device must always be secured at two lifting lugs at least.

5.2.3 Transporting with a fork lift

If transporting in wood crates, the floor structure enables the crates to be lifted lengthwise or at both sides using a forklift.

5.3 Packaging disposal

All packaging materials are environmentally friendly and 100% recyclable:

- Measuring device secondary packaging: polymer stretch film that conforms to EC Directive 2002/95/EC (RoHS).
- Packaging:
 - Wood crate, treated in accordance with ISPM 15 standard, which is confirmed by the affixed IPPC logo.
 - or
 - Carton in accordance with European Packaging Directive 94/62EC; recyclability is confirmed by the affixed RESY symbol.
- Seaworthy packaging (optional): Wood crate, treated in accordance with ISPM 15 standard, which is confirmed by the affixed IPPC logo.
- Carrying and mounting hardware:
 - Disposable plastic pallet
 - Plastic straps
 - Plastic adhesive strips
- Dunnage: Paper cushion

6 Installation

6.1 Installation conditions

No special measures such as supports are necessary. External forces are absorbed by the construction of the device.

6.1.1 Mounting position

Mounting location

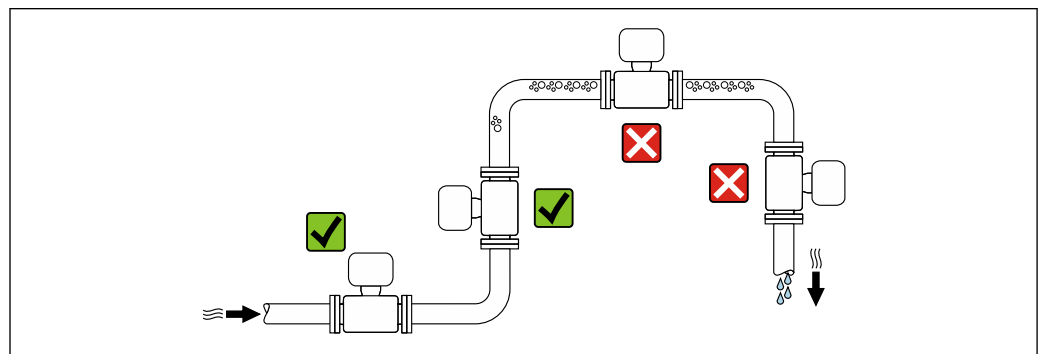

A0028772

To prevent measuring errors arising from accumulation of gas bubbles in the measuring tube, avoid the following mounting locations in the pipe:

- Highest point of a pipeline.
- Directly upstream of a free pipe outlet in a down pipe.

Installation in down pipes

However, the following installation suggestion allows for installation in an open vertical pipeline. Pipe restrictions or the use of an orifice with a smaller cross-section than the nominal diameter prevent the sensor running empty while measurement is in progress.

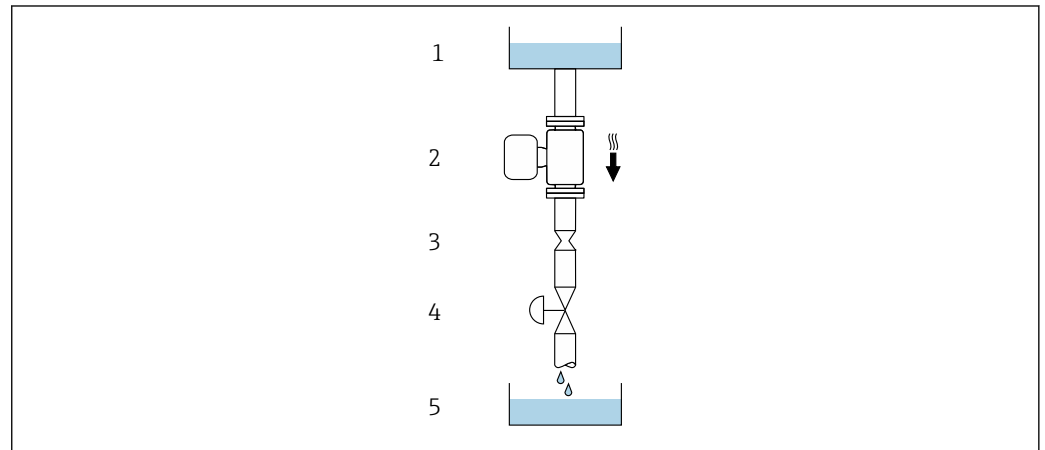

A0028773

6 Installation in a down pipe (e.g. for batching applications)

- 1 Supply tank
- 2 Sensor
- 3 Orifice plate, pipe restriction
- 4 Valve
- 5 Batching tank





DN		Ø orifice plate, pipe restriction	
[mm]	[in]	[mm]	[in]
80	3	50	1.97
100	4	65	2.60
150	6	90	3.54

Orientation

The direction of the arrow on the sensor nameplate helps you to install the sensor according to the flow direction (direction of medium flow through the piping).

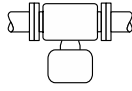
Orientation		Recommendation
A	Vertical orientation	 <small>A0015591</small>
B	Horizontal orientation, transmitter at top	 <small>A0015589</small>

✓✓¹⁾
 Exceptions:
 → 7, 24

Orientation		Recommendation
C	Horizontal orientation, transmitter at bottom	 <small>A0015590</small> ✓✓ ²⁾ Exceptions: →  ,  24
D	Horizontal orientation, transmitter at side	 <small>A0015592</small> ✗

- 1) Applications with low process temperatures may decrease the ambient temperature. To maintain the minimum ambient temperature for the transmitter, this orientation is recommended.
- 2) Applications with high process temperatures may increase the ambient temperature. To maintain the maximum ambient temperature for the transmitter, this orientation is recommended.

If a sensor is installed horizontally with a curved measuring tube, match the position of the sensor to the fluid properties.

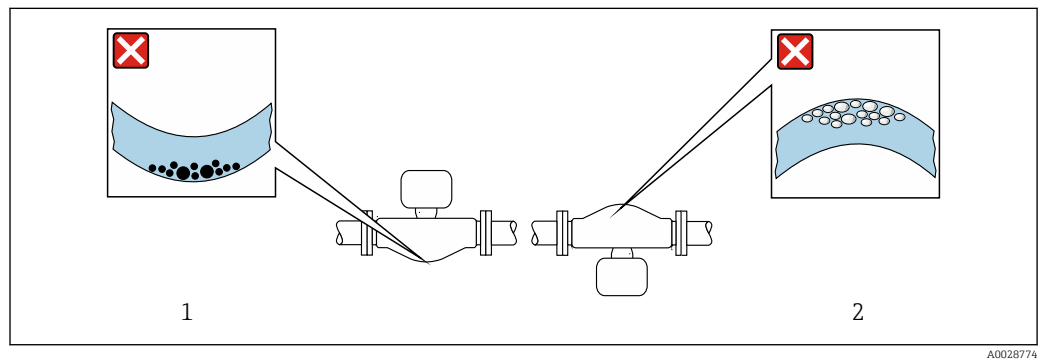

 7 Orientation of sensor with curved measuring tube

- 1 Avoid this orientation for fluids with entrained solids: Risk of solids accumulating.
- 2 Avoid this orientation for outgassing fluids: Risk of gas accumulating.

Inlet and outlet runs

No special precautions need to be taken for fittings which create turbulence, such as valves, elbows or T-pieces, as long as no cavitation occurs →  25.

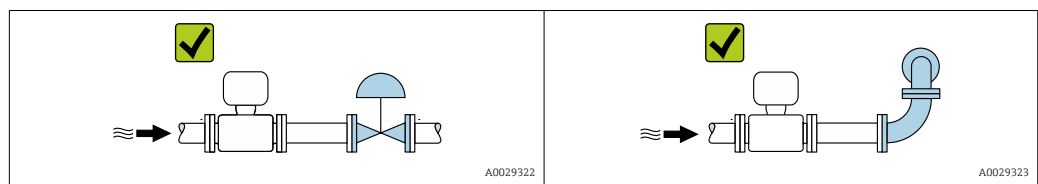

Installation dimensions

 For the dimensions and installation lengths of the device, see the "Technical Information" document, "Mechanical construction" section

6.1.2 Requirements from environment and process

Ambient temperature range

Measuring device	Non-Ex	-40 to +60 °C (-40 to +140 °F)
	Ex ec, NI version	-40 to +60 °C (-40 to +140 °F)

	Ex ia, IS version	<ul style="list-style-type: none"> ▪ -40 to +60 °C (-40 to +140 °F) ▪ Order code for "Test, certificate", option JP -50 to +60 °C (-58 to +140 °F) ▪ Order code for "Test, certificate", option JQ -60 to +60 °C (-76 to +140 °F) (sensor) -50 to +60 °C (-58 to +140 °F) (transmitter)
Readability of the local display		-20 to +60 °C (-4 to +140 °F) The readability of the display may be impaired at temperatures outside the temperature range.

- ▶ If operating outdoors:
Avoid direct sunlight, particularly in warm climatic regions.

 You can order a weather protection cover from Endress+Hauser : →  177

System pressure

It is important that cavitation does not occur, or that gases entrained in the liquids do not outgas.

Cavitation is caused if the pressure drops below the vapor pressure:

- In liquids that have a low boiling point (e.g. hydrocarbons, solvents, liquefied gases)
 - In suction lines
- ▶ Ensure the system pressure is sufficiently high to prevent cavitation and outgassing.

For this reason, the following mounting locations are recommended:

- At the lowest point in a vertical pipe
- Downstream from pumps (no danger of vacuum)

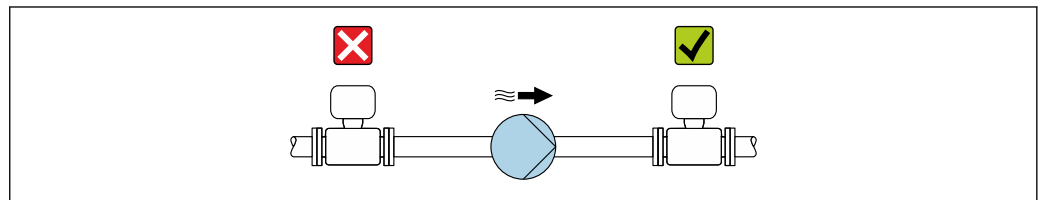

A0028777

Thermal insulation

In the case of some fluids, it is important that the heat radiated from the sensor to the transmitter is kept to a minimum. A wide range of materials can be used for the required insulation.

NOTICE

Electronics overheating on account of thermal insulation!

- ▶ Observe maximum permitted insulation height of the transmitter neck so that the transmitter head is completely free.

NOTICE

Danger of overheating with insulation

- ▶ Ensure that the temperature at the lower end of the sensor housing does not exceed 80 °C (176 °F)

NOTICE

The insulation can also be thicker than the maximum recommended insulation thickness.

Prerequisite:

- ▶ Ensure that convection takes place on a sufficiently large scale at the transmitter neck.
- ▶ Ensure that a sufficiently large area of the housing support remains exposed. The uncovered part serves as a radiator and protects the electronics from overheating and excessive cooling.

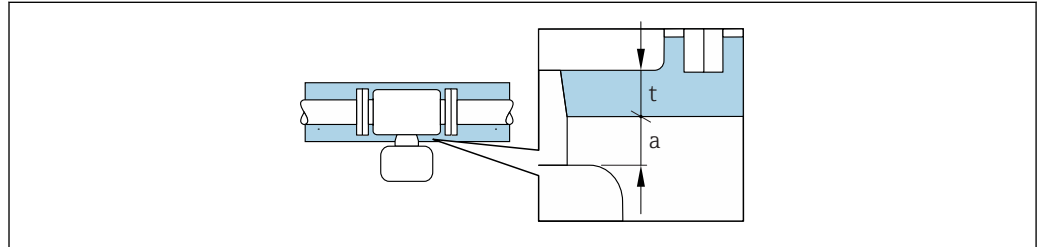

A0028853

- a Minimum distance to insulation
- t maximum Insulation thickness

The minimum distance a between the sensor connection housing and the insulation is 10 mm (0.39 in). This is to ensure that the sensor connection housing remains completely exposed.

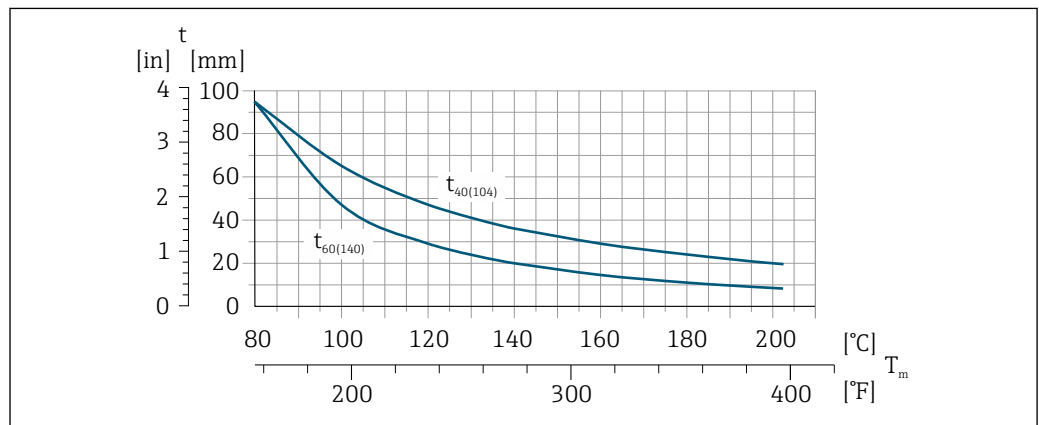

A0029921

- t Insulation thickness
- T_m Medium temperature
- $t_{40(104)}$ Maximum recommended insulation thickness at an ambient temperature of $T_a = 40\text{ °C}$ (104 °F)
- $t_{60(140)}$ Maximum recommended insulation thickness at an ambient temperature of $T_a = 60\text{ °C}$ (140 °F)

Heating

NOTICE

Electronics can overheat due to elevated ambient temperature!

- ▶ Observe maximum permitted ambient temperature for the transmitter .
- ▶ Depending on the fluid temperature, take the device orientation requirements into account .

NOTICE**Danger of overheating when heating**

- ▶ Ensure that the temperature at the lower end of the transmitter housing does not exceed 80 °C (176 °F).
- ▶ Ensure that convection takes place on a sufficiently large scale at the transmitter neck.
- ▶ Ensure that a sufficiently large area of the housing support remains exposed. The uncovered part serves as a radiator and protects the electronics from overheating and excessive cooling.

Heating options

If a fluid requires that no heat loss should occur at the sensor, users can avail of the following heating options:

- Electrical heating, e.g. with electric band heaters
- Via pipes carrying hot water or steam
- Via heating jackets

Using an electrical trace heating system

If heating is regulated via phase angle control or pulse packages, magnetic fields can affect the measured values (= for values that are greater than the values permitted by the EN standard (sine 30 A/m)).

For this reason, the sensor must be magnetically shielded: the housing can be shielded with tin plates or electric sheets without a privileged direction (e.g. V330-35A).

The sheet must have the following properties:

- Relative magnetic permeability $\mu_r \geq 300$
- Plate thickness $d \geq 0.35$ mm ($d \geq 0.014$ in)

Vibrations

The high oscillation frequency of the measuring tubes ensures that the correct operation of the measuring system is not influenced by plant vibrations.

6.1.3 Special mounting instructions**Rupture disk**

Make sure that the function and operation of the rupture disk is not impeded through the installation of the device. The position of the rupture disk is indicated on a sticker beside it.

The transportation guard must be removed.

Information that is relevant to the process: →  196.



For information on the dimensions: see the "Mechanical construction" section of the "Technical Information" document

The existing connecting nozzles are not intended for the purpose of rinsing or pressure monitoring, but instead serve as the mounting location for the rupture disk.

In the event of a failure of the rupture disk, a discharge device can be screwed onto the internal thread of the rupture disk in order to drain off any escaping medium.

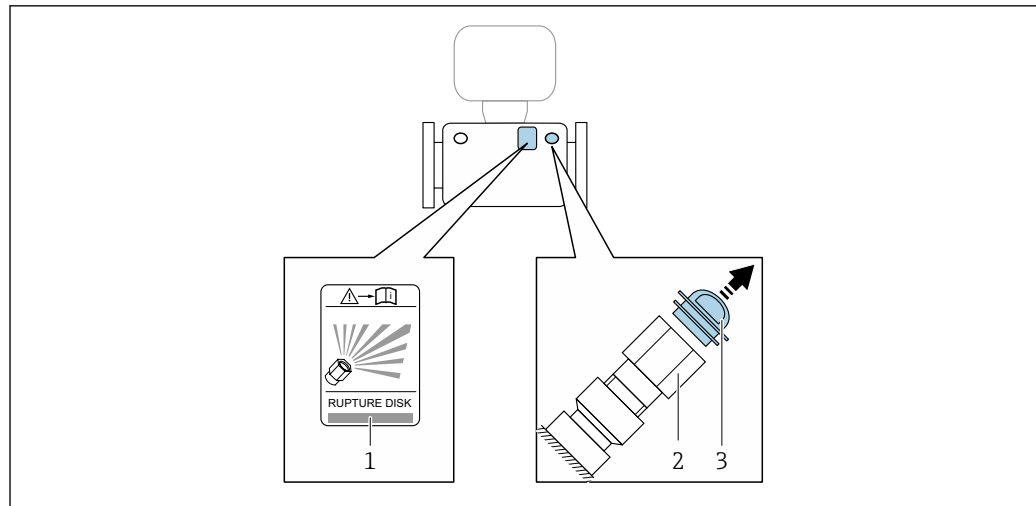

A0030346

- 1 Rupture disk label
- 2 Rupture disk with 1/2" NPT internal thread with 1" width across flat
- 3 Transport protection

⚠ WARNING

Limited functional reliability of the rupture disk.

Danger to persons from escaping fluids!

- ▶ Do not remove the rupture disk.
- ▶ When using a rupture disk, do not use a heating jacket.
- ▶ Make sure that the function and operation of the rupture disk is not impeded through the installation of the device.
- ▶ Take precautions to prevent damage and danger to persons if the rupture disk is actuated.
- ▶ Observe information on the rupture disk sticker.

Zero point adjustment

All measuring devices are calibrated in accordance with state-of-the-art technology. Calibration takes place under reference conditions → ☰ 190. Therefore, a zero point adjustment in the field is generally not required.

Experience shows that zero point adjustment is advisable only in special cases:

- To achieve maximum measuring accuracy even with low flow rates
- Under extreme process or operating conditions (e.g. very high process temperatures or very high-viscosity fluids).

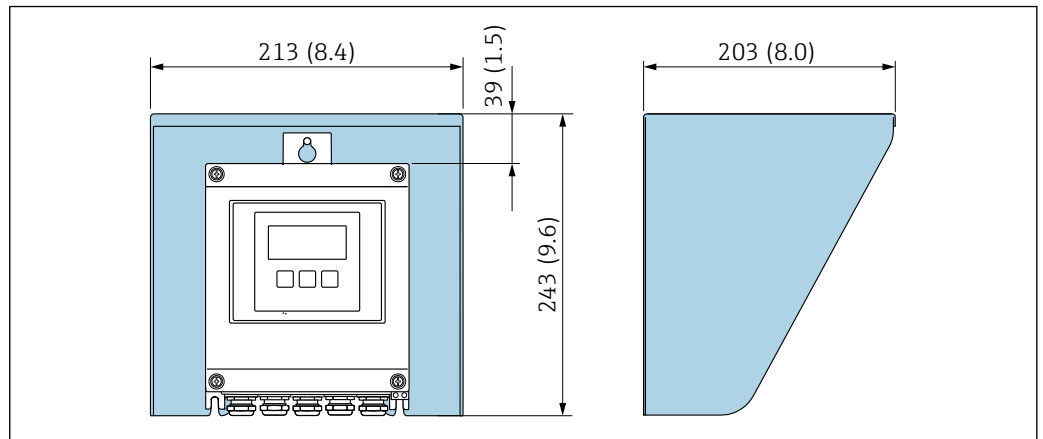
Protective cover

A0029552

8 Weather protection cover for Proline 500 – digital

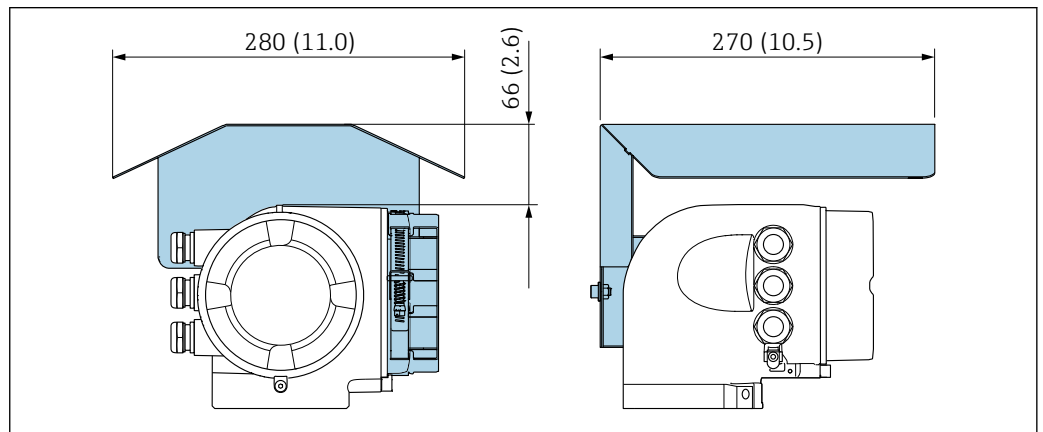

A0029553

9 Weather protection cover for Proline 500

Cover locking: Proline 500**NOTICE**

Order code for "Housing", option L "Cast, stainless": The covers of the transmitter housing are provided with a borehole to lock the cover.

The cover can be locked using screws and a chain or cable provided by the customer.

- ▶ It is recommended to use stainless steel cables or chains.
- ▶ If a protective coating is applied, it is recommended to use a heat shrink tube to protect the housing paint.

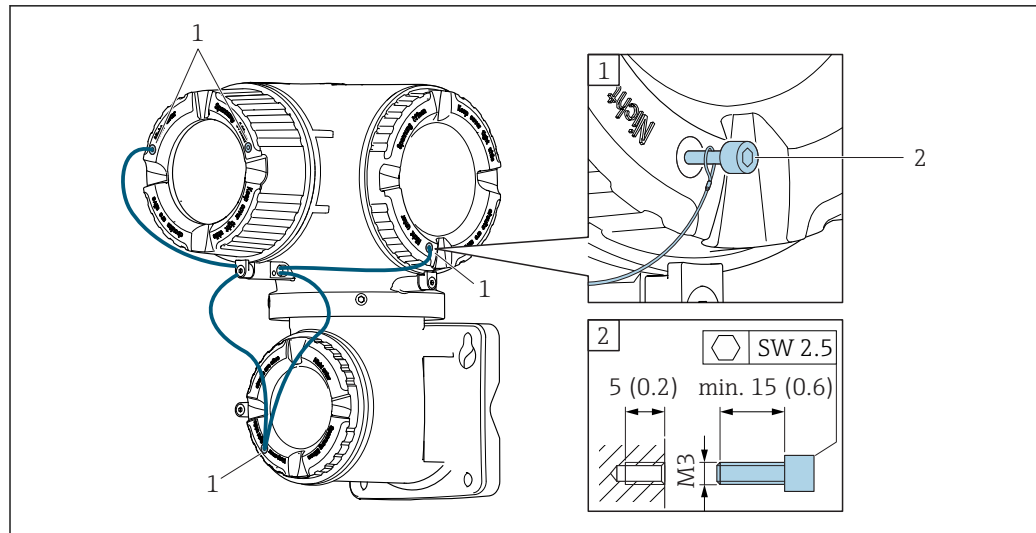

A0029799

- 1 Cover borehole for the securing screw
 2 Securing screw to lock the cover

6.2 Mounting the measuring device

6.2.1 Required tools

For transmitter

For mounting on a post:

- Proline 500 – digital transmitter
 - Open-ended wrench AF 10
 - Torx screwdriver TX 25
- Proline 500 transmitter
 - Open-ended wrench AF 13

For wall mounting:

Drill with drill bit \varnothing 6.0 mm

For sensor

For flanges and other process connections: Corresponding mounting tools

6.2.2 Preparing the measuring device

1. Remove all remaining transport packaging.
2. Remove any protective covers or protective caps present from the sensor.
3. Remove stick-on label on the electronics compartment cover.

6.2.3 Mounting the measuring device

⚠ WARNING

Danger due to improper process sealing!

- ▶ Ensure that the inside diameters of the gaskets are greater than or equal to that of the process connections and piping.
- ▶ Ensure that the gaskets are clean and undamaged.
- ▶ Install the gaskets correctly.

1. Ensure that the direction of the arrow on the nameplate of the sensor matches the flow direction of the fluid.

2. Install the measuring device or turn the transmitter housing so that the cable entries do not point upwards.

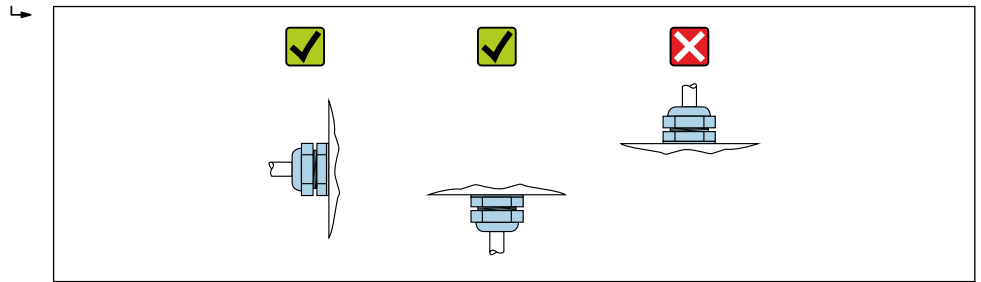

A0029263

6.2.4 Mounting the transmitter housing: Proline 500 – digital

⚠ CAUTION

Ambient temperature too high!

Danger of electronics overheating and housing deformation.

- ▶ Do not exceed the permitted maximum ambient temperature .
- ▶ If operating outdoors: Avoid direct sunlight and exposure to weathering, particularly in warm climatic regions.

⚠ CAUTION

Excessive force can damage the housing!

- ▶ Avoid excessive mechanical stress.

The transmitter can be mounted in the following ways:

- Post mounting
- Wall mounting

Post mounting

⚠ WARNING

Excessive tightening torque applied to the fixing screws!

Risk of damaging the plastic transmitter.

- ▶ Tighten the fixing screws as per the tightening torque: 2 Nm (1.5 lbf ft).

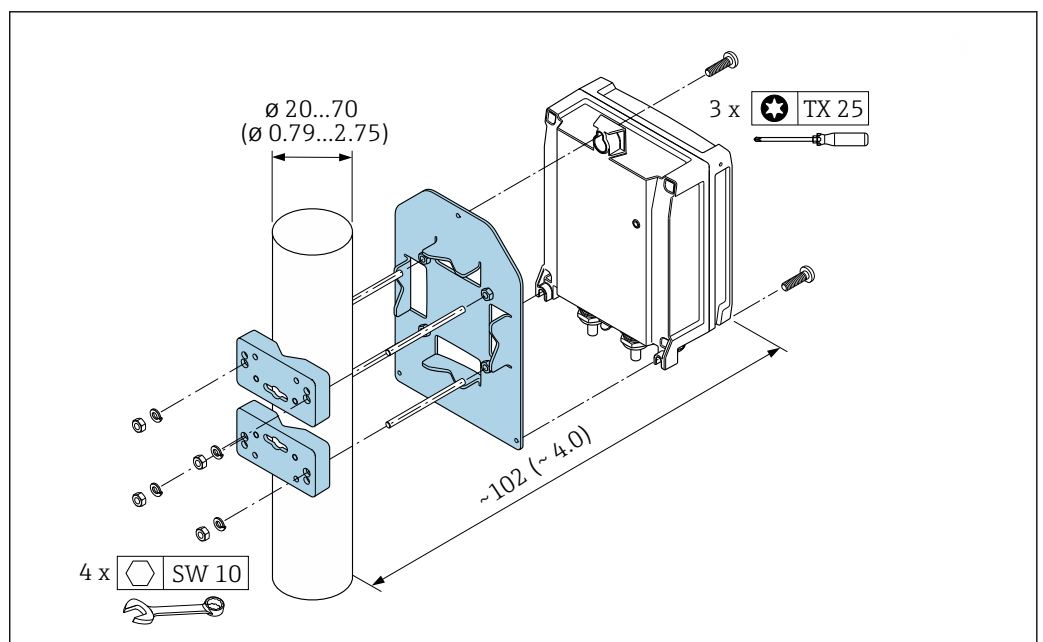

A0029051

10 Engineering unit mm (in)

Wall mounting

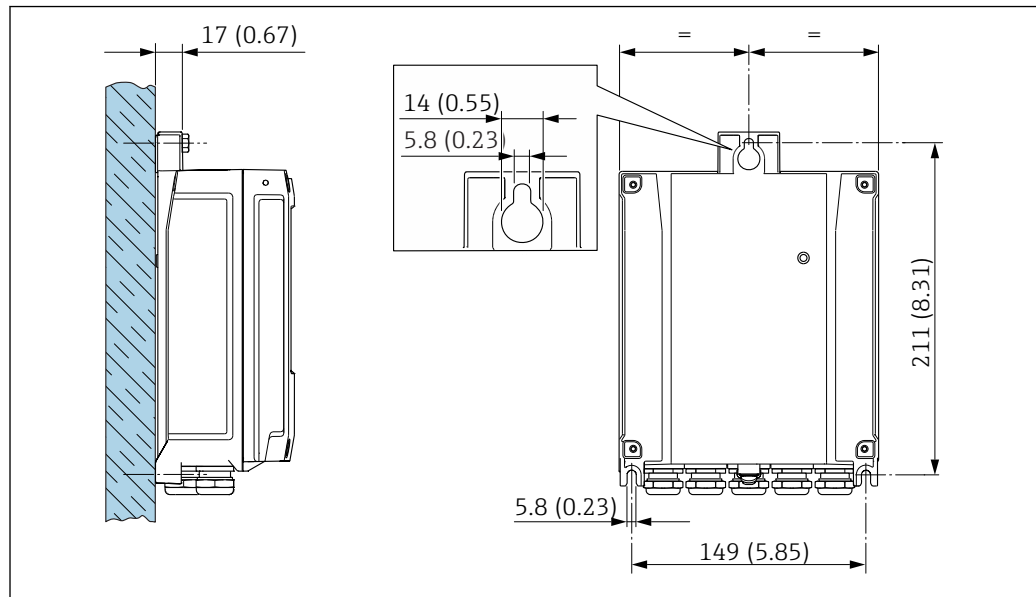

11 Engineering unit mm (in)

1. Drill the holes.
2. Insert wall plugs into the drilled holes.
3. Screw in the securing screws slightly at first.
4. Fit the transmitter housing over the securing screws and mount in place.
5. Tighten the securing screws.

6.2.5 Mounting the transmitter housing: Proline 500

⚠ CAUTION

Ambient temperature too high!

Danger of electronics overheating and housing deformation.

- ▶ Do not exceed the permitted maximum ambient temperature .
- ▶ If operating outdoors: Avoid direct sunlight and exposure to weathering, particularly in warm climatic regions.

⚠ CAUTION

Excessive force can damage the housing!

- ▶ Avoid excessive mechanical stress.

The transmitter can be mounted in the following ways:

- Post mounting
- Wall mounting

Post mounting

⚠ WARNING

Order code for "Transmitter housing", option L "Cast, stainless": cast transmitters are very heavy.

They are unstable if they are not mounted on a secure, fixed post.

- ▶ Only mount the transmitter on a secure, fixed post on a stable surface.

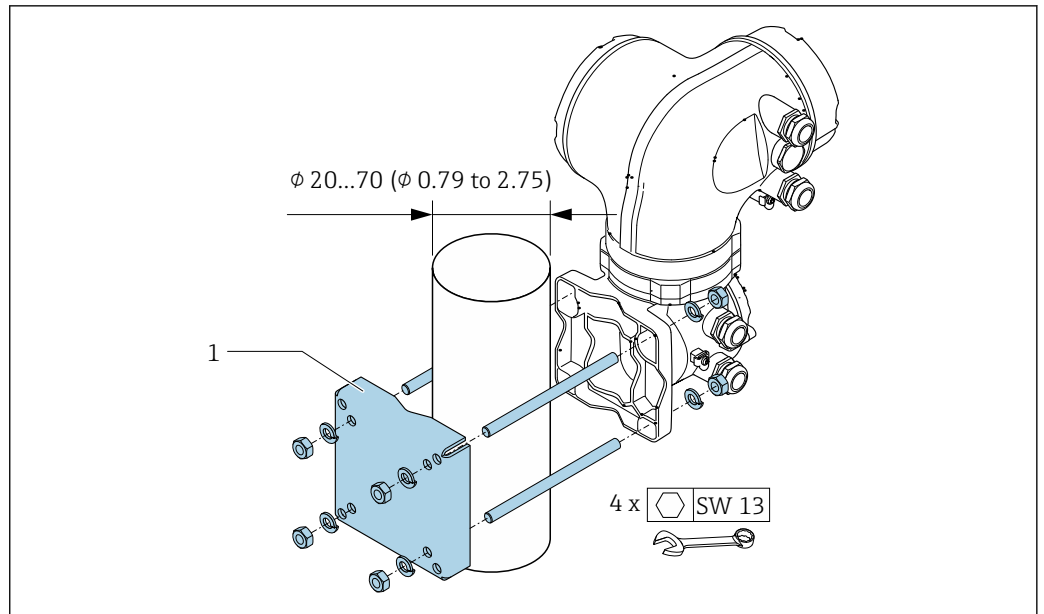

12 Engineering unit mm (in)

Wall mounting

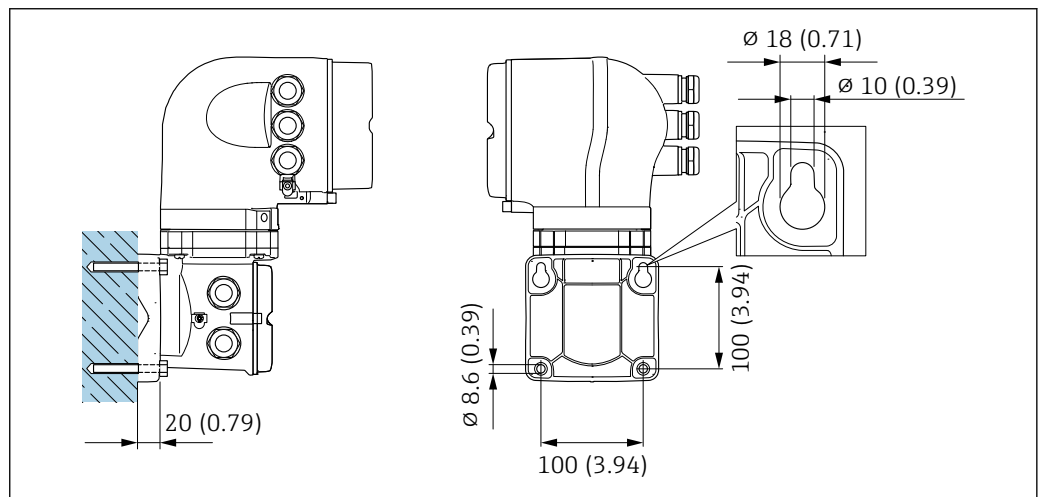

13 Engineering unit mm (in)

1. Drill the holes.
2. Insert wall plugs into the drilled holes.
3. Screw in the securing screws slightly at first.
4. Fit the transmitter housing over the securing screws and mount in place.
5. Tighten the securing screws.

6.2.6 Turning the transmitter housing: Proline 500

To provide easier access to the connection compartment or display module, the transmitter housing can be turned.

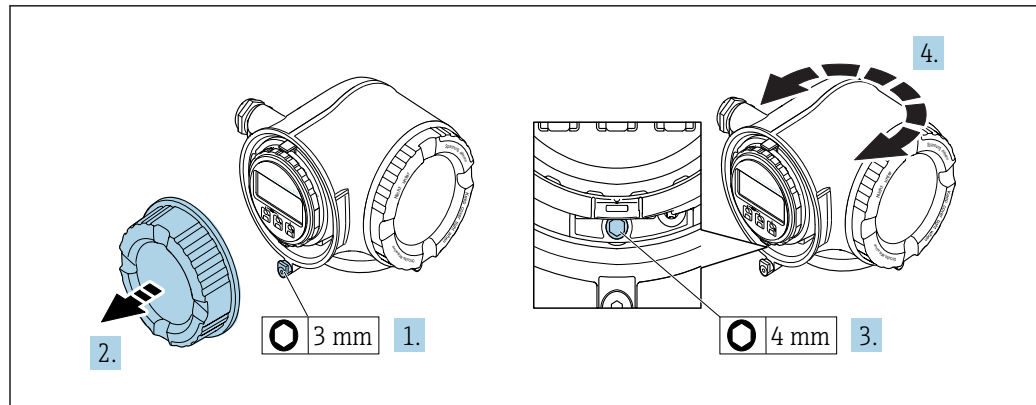

A0029993

1. Loosen the securing clamp of the connection compartment cover.
2. Unscrew the connection compartment cover.
3. Release the fixing screw.
4. Turn the housing to the desired position.
5. Firmly tighten the securing screw.
6. Screw on the connection compartment cover
7. Fit the securing clamp of the connection compartment cover.

6.2.7 Turning the display module: Proline 500

The display module can be turned to optimize display readability and operability.

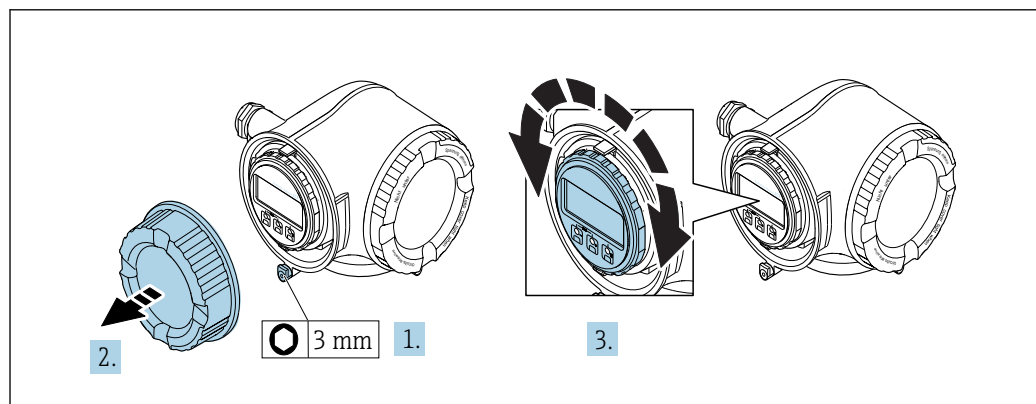

A0030035

1. Loosen the securing clamp of the connection compartment cover.
2. Unscrew the connection compartment cover.
3. Turn the display module to the desired position: max. $8 \times 45^\circ$ in every direction.
4. Screw on the connection compartment cover.
5. Fit the securing clamp of the connection compartment cover.

6.3 Post-installation check

Is the device undamaged (visual inspection)?	<input type="checkbox"/>
Does the measuring device conform to the measuring point specifications? For example: <ul style="list-style-type: none"> ▪ Process temperature → 195 ▪ Process pressure (refer to the chapter on "Pressure-temperature ratings" of the "Technical Information" document) ▪ Ambient temperature ▪ Measuring range 	<input type="checkbox"/>
Has the correct orientation for the sensor been selected ? <ul style="list-style-type: none"> ▪ According to sensor type ▪ According to medium temperature ▪ According to medium properties (outgassing, with entrained solids) 	<input type="checkbox"/>
Does the arrow on the sensor nameplate match the direction of flow of the fluid through the piping → 23?	<input type="checkbox"/>
Are the measuring point identification and labeling correct (visual inspection)?	<input type="checkbox"/>
Is the device adequately protected from precipitation and direct sunlight?	<input type="checkbox"/>
Are the securing screw and securing clamp tightened securely?	<input type="checkbox"/>

7 Electrical connection

NOTICE

The measuring device does not have an internal circuit breaker.

- ▶ For this reason, assign the measuring device a switch or power-circuit breaker so that the power supply line can be easily disconnected from the mains.
- ▶ Although the measuring device is equipped with a fuse, additional overcurrent protection (maximum 10 A) should be integrated into the system installation.

7.1 Connection conditions

7.1.1 Required tools

- For cable entries: Use corresponding tools
- For securing clamp: Allen key 3 mm
- Wire stripper
- When using stranded cables: crimper for wire end ferrule
- For removing cables from terminal: Flat blade screwdriver ≤ 3 mm (0.12 in)

7.1.2 Requirements for connecting cable

The connecting cables provided by the customer must fulfill the following requirements.

Electrical safety

In accordance with applicable federal/national regulations.

Protective ground cable

Cable: 2.1 mm² (14 AWG)

The grounding impedance must be less than 1 Ω .

Permitted temperature range

Minimum requirement: cable temperature range \geq ambient temperature +20 K

Power supply cable

Standard installation cable is sufficient.

Signal cable

Current output 4 to 20 mA HART

A shielded cable is recommended. Observe grounding concept of the plant.

Current output 0/4 to 20 mA

Standard installation cable is sufficient.

Pulse/frequency/switch output

Standard installation cable is sufficient.

Double pulse output

Standard installation cable is sufficient.

Relay output

Standard installation cable is sufficient.

Current input 0/4 to 20 mA

Standard installation cable is sufficient.

Status input

Standard installation cable is sufficient.

Cable diameter

- Cable glands supplied:
M20 × 1.5 with cable \varnothing 6 to 12 mm (0.24 to 0.47 in)
- Spring terminals:
Conductor cross-section 0.2 to 2.5 mm² (24 to 12 AWG)

Connecting cable for sensor - transmitter: Proline 500 – digital

Non-hazardous area, Ex Zone 2, Class I, Division 2

Standard cable

A standard cable can be used as the connecting cable.

Standard cable	4 cores (2 pairs); twisted pair with common shield
Shielding	Tin-plated copper-braid, optical cover \geq 85 %
Loop resistance	Power supply line (+, -): maximum 10 Ω
Cable length	Maximum 300 m (1000 ft), see the following table.

Cross-section	Cable length
0.34 mm ² (AWG 22)	80 m (270 ft)
0.50 mm ² (AWG 20)	120 m (400 ft)
0.75 mm ² (AWG 18)	180 m (600 ft)
1.00 mm ² (AWG 17)	240 m (800 ft)
1.50 mm ² (AWG 15)	300 m (1000 ft)

Optionally available connecting cable

Standard cable	2 × 2 × 0.34 mm ² (AWG 22) PVC cable with common shield (2 pairs, twisted pair)
Flame resistance	According to DIN EN 60332-1-2
Oil-resistance	According to DIN EN 60811-2-1
Shielding	Tin-plated copper-braid, optical cover \geq 85 %
Operating temperature	When mounted in a fixed position: -50 to +105 °C (-58 to +221 °F); when cable can move freely: -25 to +105 °C (-13 to +221 °F)
Available cable length	Fixed: 20 m (65 ft); variable: up to maximum 50 m (165 ft)



Hazardous area, Ex Zone 1, Class I, Division 1

Standard cable

A standard cable can be used as the connecting cable.

Standard cable	4, 6, 8 cores (2, 3, 4 pairs); twisted pair with common shield
Shielding	Tin-plated copper-braid, optical cover \geq 85 %
Capacitance C	Maximum 730 nF IIC, maximum 4.2 μ F IIB

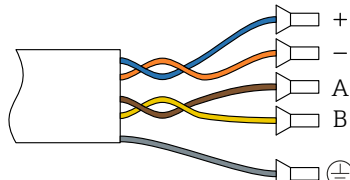
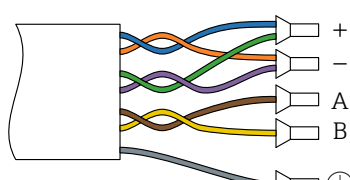
Inductance L	Maximum 26 μH IIC, maximum 104 μH IIB
Inductance/resistance ratio (L/R)	Maximum 8.9 $\mu\text{H}/\Omega$ IIC, maximum 35.6 $\mu\text{H}/\Omega$ IIB (e.g. in accordance with IEC 60079-25)
Loop resistance	Power supply line (+, -): maximum 5 Ω
Cable length	Maximum 150 m (500 ft), see the following table.

Cross-section	Cable length	Assembly
2 x 2 x 0.50 mm ² (AWG 22)	50 m (165 ft)	2 x 2 x 0.50 mm ² (AWG 22)  <ul style="list-style-type: none"> ■ +, - = 0.5 mm² ■ A, B = 0.5 mm²
3 x 2 x 0.50 mm ² (AWG 22)	100 m (330 ft)	3 x 2 x 0.50 mm ² (AWG 22)  <ul style="list-style-type: none"> ■ +, - = 1.0 mm² ■ A, B = 0.5 mm²
4 x 2 x 0.50 mm ² (AWG 22)	150 m (500 ft)	4 x 2 x 0.50 mm ² (AWG 22)  <ul style="list-style-type: none"> ■ +, - = 1.5 mm² ■ A, B = 0.5 mm²

Optionally available connecting cable

Connecting cable for	Ex Zone 1, Class I, Division 1, IIC, IIB
Standard cable	2 × 2 × 0.5 mm ² (AWG 20) PVC cable with common shield (2 pairs, twisted pair)
Flame resistance	According to DIN EN 60332-1-2
Oil-resistance	According to DIN EN 60811-2-1
Shielding	Tin-plated copper-braid, optical cover ≥ 85 %
Operating temperature	When mounted in a fixed position: -50 to +105 °C (-58 to +221 °F); when cable can move freely: -25 to +105 °C (-13 to +221 °F)
Available cable length	Fixed: 20 m (65 ft); variable: up to maximum 50 m (165 ft)

Connecting cable for sensor - Proline 500 transmitter

Standard cable	6 × 0.38 mm ² PVC cable with common shield and individual shielded cores
Conductor resistance	≤50 Ω/km (0.015 Ω/ft)
Capacitance: core/shield	≤420 pF/m (128 pF/ft)
Cable length (max.)	20 m (65 ft)
Cable lengths (available for order)	5 m (15 ft), 10 m (32 ft), 20 m (65 ft)
Operating temperature	max. 105 °C (221 °F)

Operation in zones of severe electrical interference

The measuring system meets the general safety requirements → ☰ 205 and EMC specifications → ☰ 195.

Grounding is by means of the ground terminal provided for the purpose inside the connection housing. The stripped and twisted lengths of cable shield to the ground terminal must be as short as possible.

7.1.3 Terminal assignment

Transmitter: supply voltage, input/outputs

The terminal assignment of the inputs and outputs depends on the individual order version of the device. The device-specific terminal assignment is documented on an adhesive label in the terminal cover.

Supply voltage		Input/output 1		Input/output 2		Input/output 3		Input/output 4	
1 (+)	2 (-)	26 (+)	27 (-)	24 (+)	25 (-)	22 (+)	23 (-)	20 (+)	21 (-)
Device-specific terminal assignment: adhesive label in terminal cover.									

Transmitter and sensor connection housing: connecting cable

The sensor and transmitter, which are mounted in separate locations, are interconnected by a connecting cable. The cable is connected via the sensor connection housing and the transmitter housing.

Terminal assignment and connection of the connecting cable:

- Proline 500 – digital → ☰ 41
- Proline 500 → ☰ 48

7.1.4 Preparing the measuring device

Carry out the steps in the following order:

1. Mount the sensor and transmitter.
2. Connection housing, sensor: Connect connecting cable.
3. Transmitter: Connect connecting cable.
4. Transmitter: Connect signal cable and cable for supply voltage.

NOTICE

Insufficient sealing of the housing!

Operational reliability of the measuring device could be compromised.

- ▶ Use suitable cable glands corresponding to the degree of protection.

1. Remove dummy plug if present.
2. If the measuring device is supplied without cable glands:
Provide suitable cable gland for corresponding connecting cable.
3. If the measuring device is supplied with cable glands:
Observe requirements for connecting cables →  36.

7.2 Connecting the measuring device: Proline 500 – digital

NOTICE

Limitation of electrical safety due to incorrect connection!

- ▶ Have electrical connection work carried out by correspondingly trained specialists only.
- ▶ Observe applicable federal/national installation codes and regulations.
- ▶ Comply with local workplace safety regulations.
- ▶ Always connect the protective ground cable ⊕ before connecting additional cables.
- ▶ For use in potentially explosive atmospheres, observe the information in the device-specific Ex documentation.

7.2.1 Connecting the connecting cable

⚠ WARNING

Risk of damaging the electronic components!

- ▶ Connect the sensor and transmitter to the same potential equalization.
- ▶ Only connect the sensor to a transmitter with the same serial number.
- ▶ Ground the connection housing of the sensor via the external screw terminal.

Terminal assignment

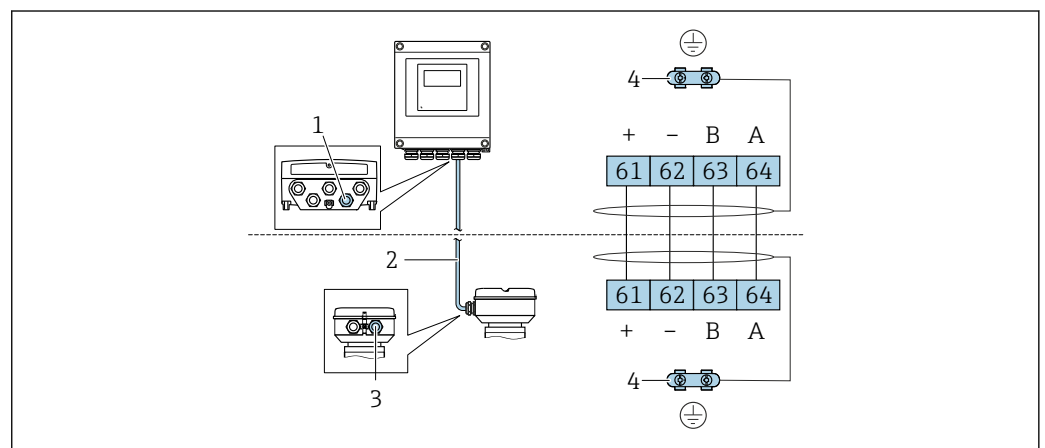

A0028198

- 1 Cable entry for connecting cable on transmitter housing
- 2 Connecting cable ISEM communication
- 3 Cable entry for connecting cable or connector on sensor connection housing
- 4 Grounding via cable strain relief

Connecting the connecting cable to the sensor connection housing

- Connection via terminals with order code for "Sensor connection housing":
 - Option **A** "Aluminum, coated" → 42
 - Option **B** "Stainless" → 43
 - Option **L** "Cast, stainless" → 42
- Connection via connectors with order code for "Sensor connection housing":
 - Option **C** "Ultra-compact hygienic, stainless" → 44

Connecting the connecting cable to the transmitter

The cable is connected to the transmitter via terminals → 45.

Connecting the sensor connection housing via terminals

For the device version with the order code for "Sensor connection housing":

- Option A "Aluminum coated"
- Option L "Cast, stainless"

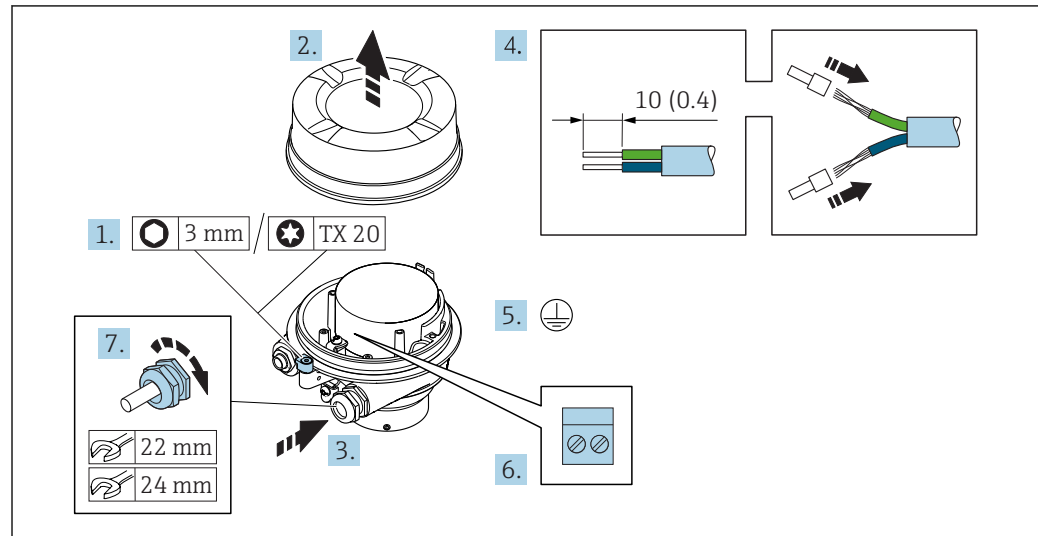

1. Loosen the securing clamp of the housing cover.
2. Unscrew the housing cover.
3. Push the cable through the cable entry . To ensure tight sealing, do not remove the sealing ring from the cable entry.
4. Strip the cable and cable ends. In the case of stranded cables, fit ferrules.
5. Connect the protective ground.
6. Connect the cable in accordance with the terminal assignment → 41.
7. Firmly tighten the cable glands.
 - ↳ This concludes the process for connecting the connecting cable.

⚠ WARNING

Housing degree of protection voided due to insufficient sealing of the housing.

- ▶ Screw in the thread on the cover without using any lubricant. The thread on the cover is coated with a dry lubricant.

8. Screw on the housing cover.
9. Tighten the securing clamp of the housing cover.

Connecting the sensor connection housing via terminals

For the device version with the order code for "Sensor connection housing":
Option B "Stainless"

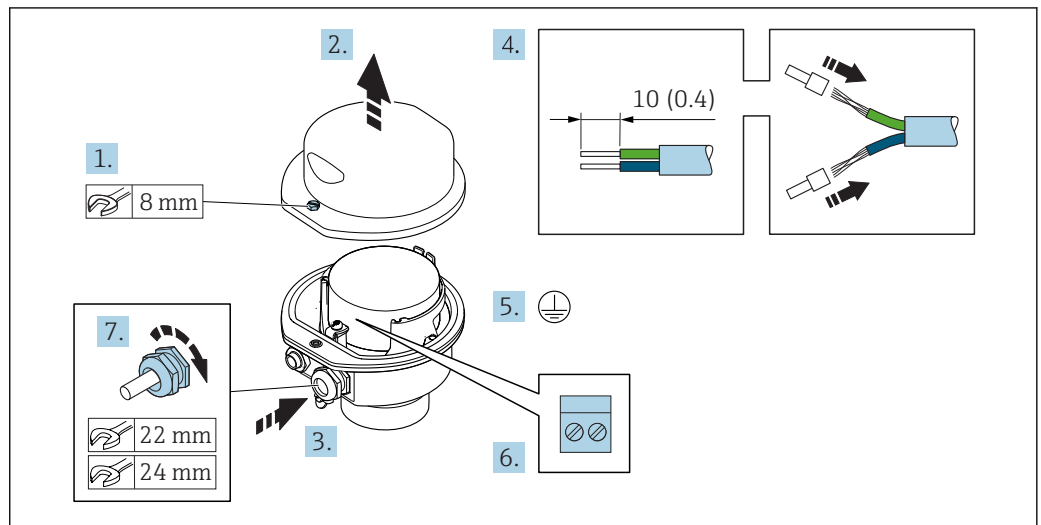

A0029613

1. Release the securing screw of the housing cover.
2. Open the housing cover.
3. Push the cable through the cable entry . To ensure tight sealing, do not remove the sealing ring from the cable entry.
4. Strip the cable and cable ends. In the case of stranded cables, fit ferrules.
5. Connect the protective ground.
6. Connect the cable in accordance with the terminal assignment → 41.
7. Firmly tighten the cable glands.
 - ↳ This concludes the process for connecting the connecting cable.
8. Close the housing cover.
9. Tighten the securing screw of the housing cover.

Connecting the sensor connection housing via the connector

For the device version with the order code for "Sensor connection housing":
Option **C** "Ultra-compact hygienic, stainless"

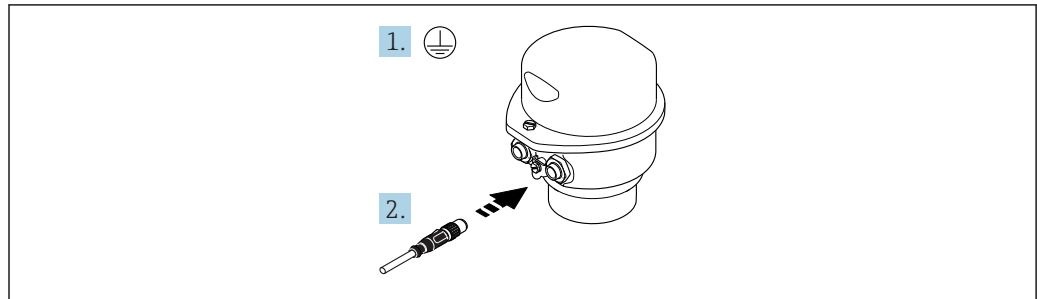

A0029615

1. Connect the protective ground.
2. Connect the connector.

Connecting the connecting cable to the transmitter

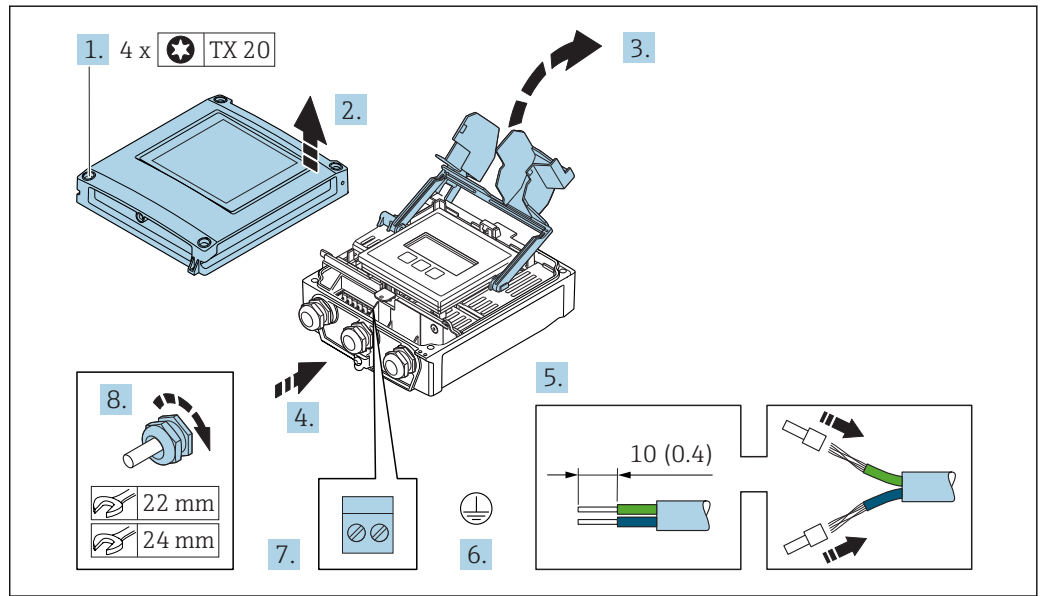

A0029597

1. Loosen the 4 fixing screws on the housing cover.
2. Open the housing cover.
3. Fold open the terminal cover.
4. Push the cable through the cable entry . To ensure tight sealing, do not remove the sealing ring from the cable entry.
5. Strip the cable and cable ends. In the case of stranded cables, fit ferrules.
6. Connect the protective ground.
7. Connect the cable in accordance with the terminal assignment → 41.
8. Firmly tighten the cable glands.
 - ↳ This concludes the process for connecting the connecting cable.
9. Close the housing cover.
10. Tighten the securing screw of the housing cover.
11. After connecting the connecting cable:
 - Connect the signal cable and the supply voltage cable → 46.

7.2.2 Connecting the signal cable and the supply voltage cable

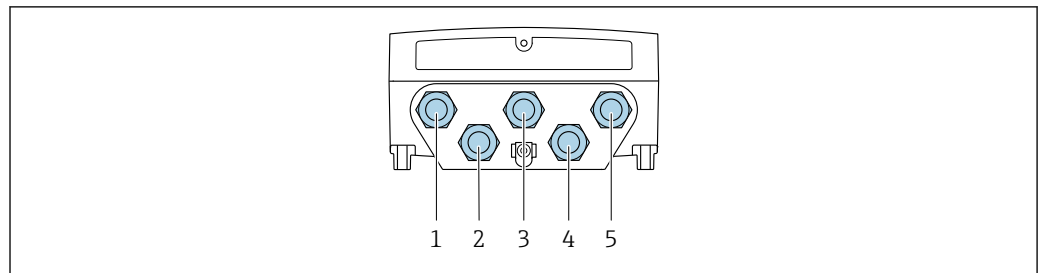

A0028200

- 1 Cable entry for supply voltage
- 2 Cable entry for cable or connection of device plug for signal transmission
- 3 Cable entry for cable or connection of device plug for signal transmission
- 4 Cable entry for sensor - transmitter connecting cable
- 5 Cable entry for cable or connection of device plug for signal transmission, optional: connection of external WLAN antenna or service connector

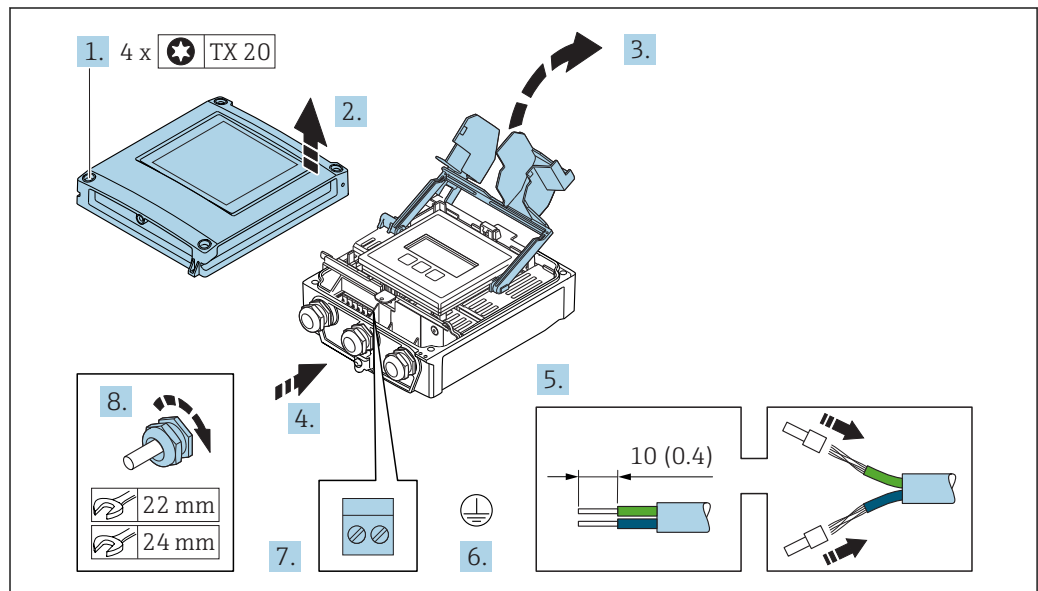

A0029597

1. Loosen the 4 fixing screws on the housing cover.
2. Open the housing cover.
3. Fold open the terminal cover.
4. Push the cable through the cable entry . To ensure tight sealing, do not remove the sealing ring from the cable entry.
5. Strip the cable and cable ends. In the case of stranded cables, fit ferrules.
6. Connect the protective ground.
7. Connect the cable in accordance with the terminal assignment .
 - ↳ **Signal cable terminal assignment:** The device-specific terminal assignment is documented on an adhesive label in the terminal cover.
 - Supply voltage terminal assignment:** Adhesive label in the terminal cover or → 39.
8. Firmly tighten the cable glands.
 - ↳ This concludes the cable connection process.
9. Close the terminal cover.
10. Close the housing cover.

⚠ WARNING

Housing degree of protection may be voided due to insufficient sealing of the housing.

- ▶ Screw in the screw without using any lubricant.

⚠ WARNING

Excessive tightening torque applied to the fixing screws!

Risk of damaging the plastic transmitter.

- ▶ Tighten the fixing screws as per the tightening torque: 2 Nm (1.5 lbf ft).

11. Tighten the 4 fixing screws on the housing cover.

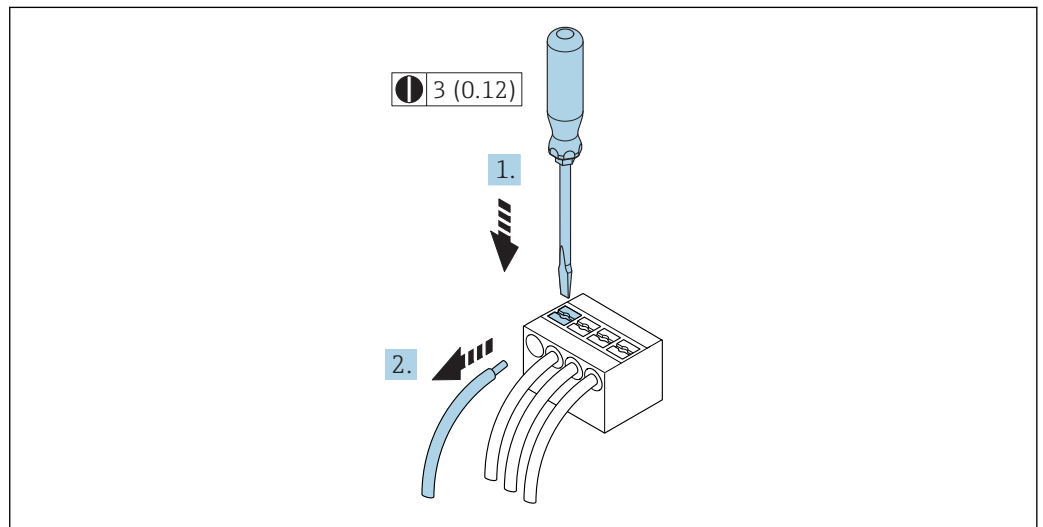
Removing a cable

14 Engineering unit mm (in)

1. To remove a cable from the terminal, use a flat-blade screwdriver to push the slot between the two terminal holes
2. while simultaneously pulling the cable end out of the terminal.

7.3 Connecting the measuring device: Proline 500

NOTICE

Limitation of electrical safety due to incorrect connection!

- ▶ Have electrical connection work carried out by correspondingly trained specialists only.
- ▶ Observe applicable federal/national installation codes and regulations.
- ▶ Comply with local workplace safety regulations.
- ▶ Always connect the protective ground cable ⊕ before connecting additional cables.
- ▶ For use in potentially explosive atmospheres, observe the information in the device-specific Ex documentation.

7.3.1 Connecting the connecting cable

⚠ WARNING

Risk of damaging the electronic components!

- ▶ Connect the sensor and transmitter to the same potential equalization.
- ▶ Only connect the sensor to a transmitter with the same serial number.
- ▶ Ground the connection housing of the sensor via the external screw terminal.

Terminal assignment

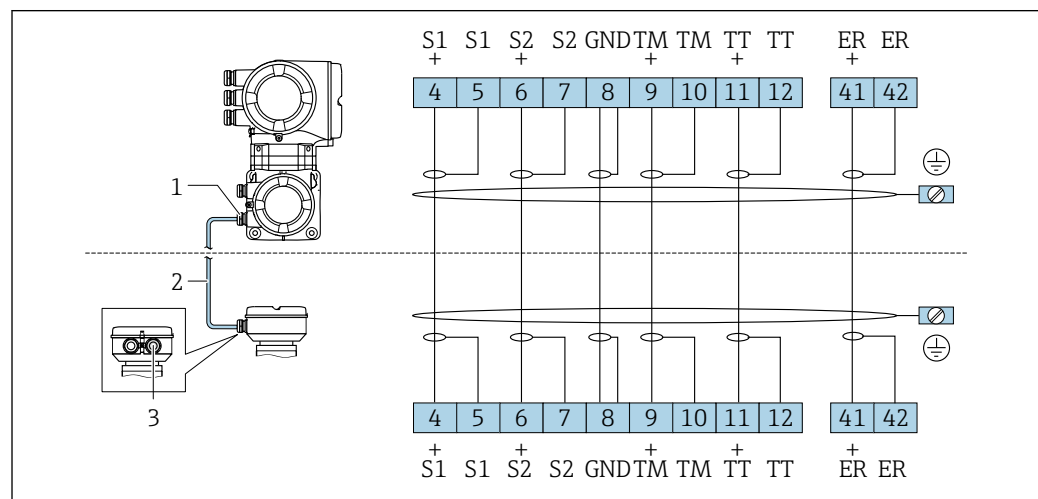

- 1 Cable entry for connecting cable on transmitter connection housing
- 2 Connecting cable
- 3 Cable entry for connecting cable on sensor connection housing

Connecting the connecting cable to the sensor connection housing

Connection via terminals with order code for "Housing":

- Option B "Stainless" → 50
- Option L "Cast, stainless" → 49

Connecting the connecting cable to the transmitter

The cable is connected to the transmitter via terminals → 51.

Connecting the sensor connection housing via terminals

For the device version with the order code for "Housing":
Option L "Cast, stainless"

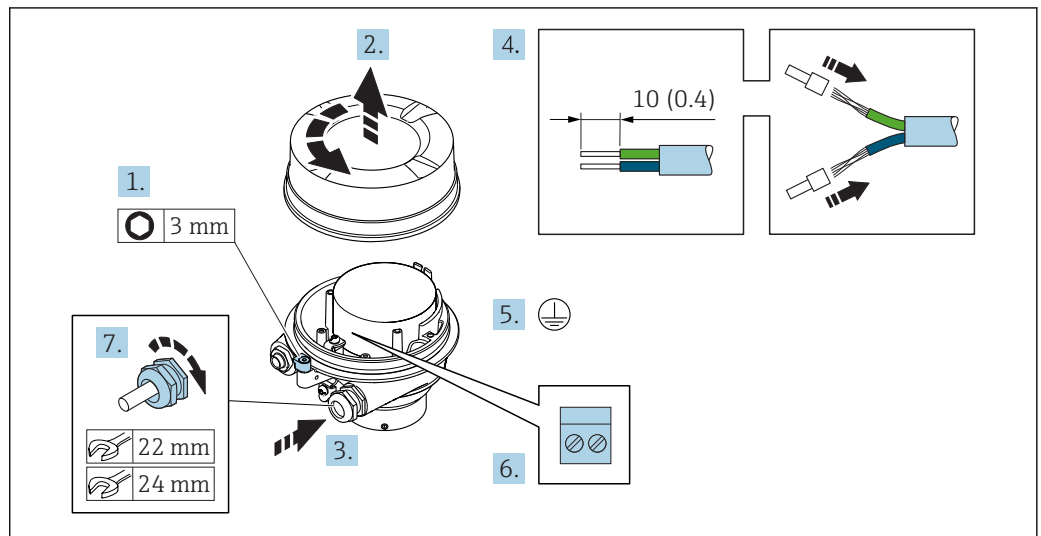

A0029612

1. Loosen the securing clamp of the housing cover.
2. Unscrew the housing cover.
3. Push the cable through the cable entry . To ensure tight sealing, do not remove the sealing ring from the cable entry.
4. Strip the cable and cable ends. In the case of stranded cables, fit ferrules.
5. Connect the protective ground.
6. Connect the cable in accordance with the terminal assignment → 48.
7. Firmly tighten the cable glands.
 - ↳ This concludes the process for connecting the connecting cable.

⚠ WARNING

Housing degree of protection voided due to insufficient sealing of the housing.

- ▶ Screw in the thread on the cover without using any lubricant. The thread on the cover is coated with a dry lubricant.
8. Screw on the housing cover.
 9. Tighten the securing clamp of the housing cover.

Connecting the sensor connection housing via terminals

For the device version with the order code for "Housing":
Option B "Stainless"

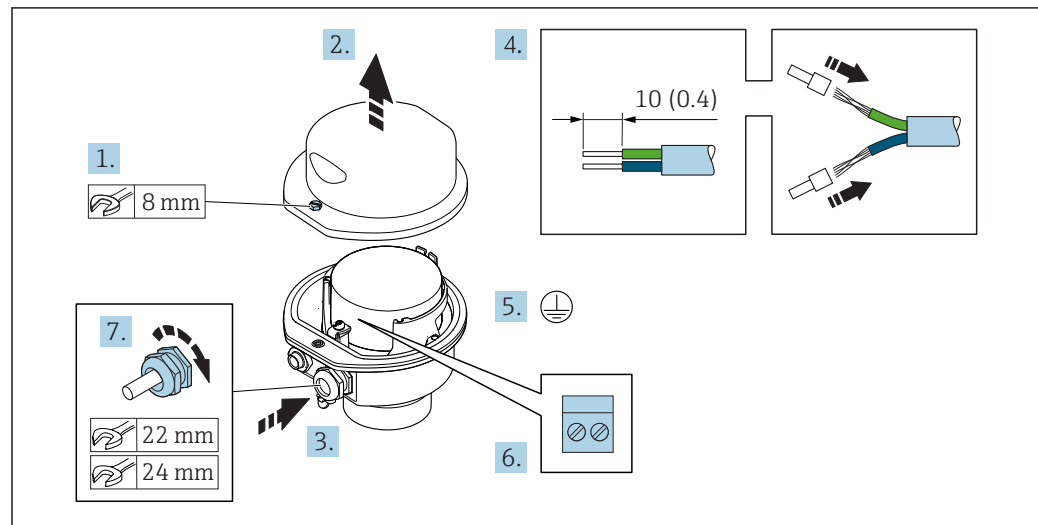

A0029613

1. Release the securing screw of the housing cover.
2. Open the housing cover.
3. Push the cable through the cable entry . To ensure tight sealing, do not remove the sealing ring from the cable entry.
4. Strip the cable and cable ends. In the case of stranded cables, fit ferrules.
5. Connect the protective ground.
6. Connect the cable in accordance with the terminal assignment → 48.
7. Firmly tighten the cable glands.
 - ↳ This concludes the process for connecting the connecting cable.
8. Close the housing cover.
9. Tighten the securing screw of the housing cover.

Connecting the connecting cable to the transmitter

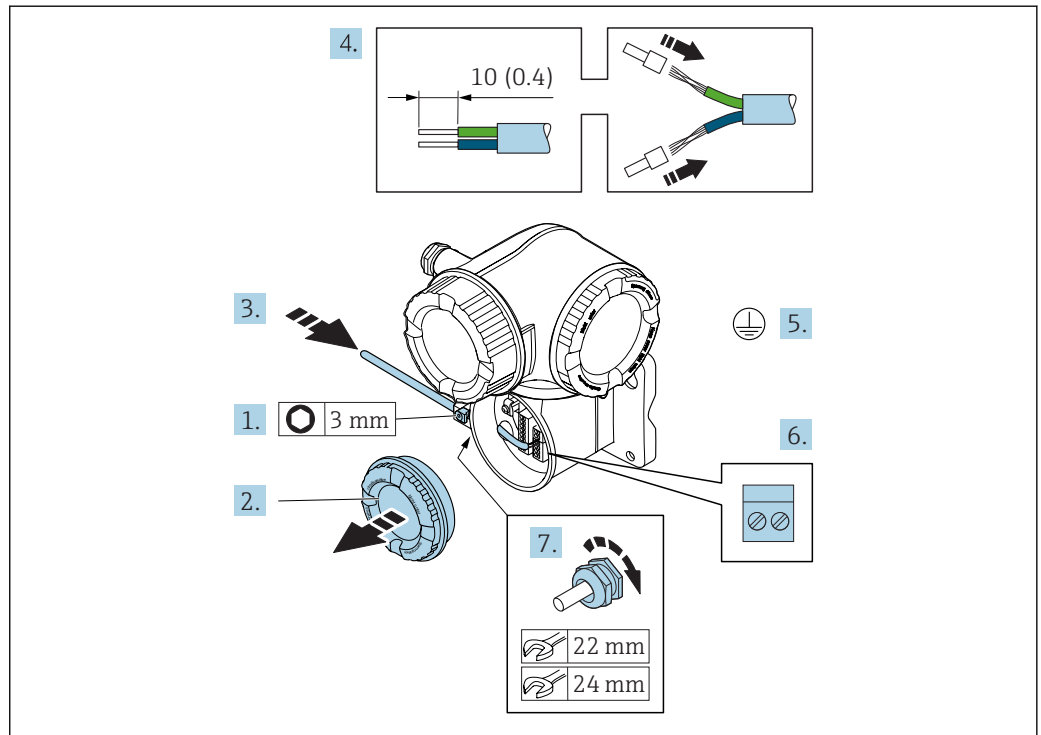

A0029592

1. Loosen the securing clamp of the connection compartment cover.
2. Unscrew the connection compartment cover.
3. Push the cable through the cable entry . To ensure tight sealing, do not remove the sealing ring from the cable entry.
4. Strip the cable and cable ends. In the case of stranded cables, also fit ferrules.
5. Connect the protective ground.
6. Connect the cable in accordance with the terminal assignment → 48.
7. Firmly tighten the cable glands.
 - ↳ This concludes the process for connecting the connecting cable.
8. Screw on the connection compartment cover.
9. Tighten the securing clamp of the connection compartment cover.
10. After connecting the connecting cable: After connecting the connecting cables: Connect the signal cable and the supply voltage cable → 52.

7.3.2 Connecting the signal cable and the supply voltage cable

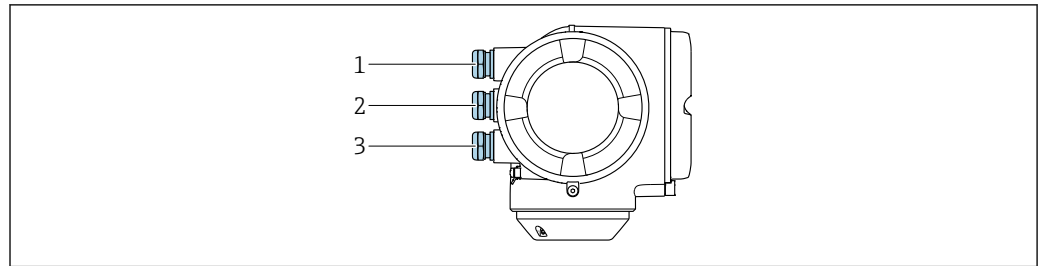

A0026781

- 1 Cable entry for supply voltage
- 2 Cable entry for signal transmission, input/output 1 and 2
- 3 Cable entry for input/output signal transmission; Optional: connection of external WLAN antenna or service plug

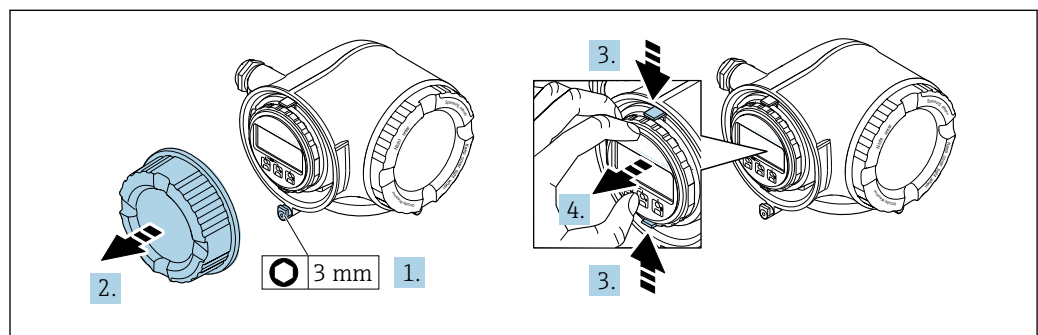

A0029813

1. Loosen the securing clamp of the connection compartment cover.
2. Unscrew the connection compartment cover.
3. Squeeze the tabs of the display module holder together.
4. Remove the display module holder.

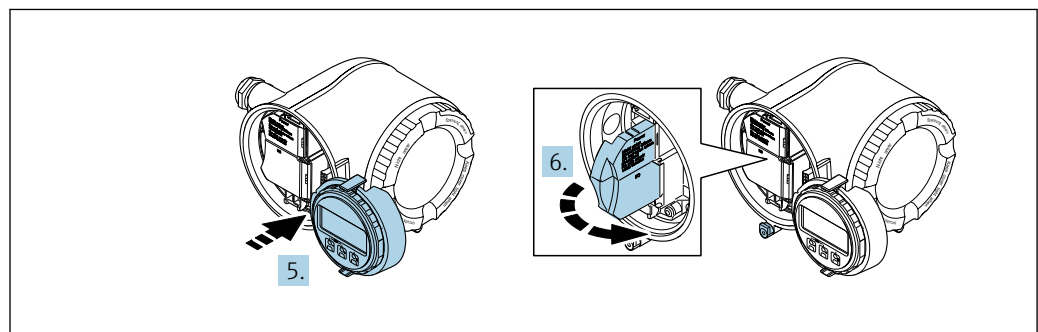

A0029814

5. Attach the holder to the edge of the electronics compartment.
6. Open the terminal cover.

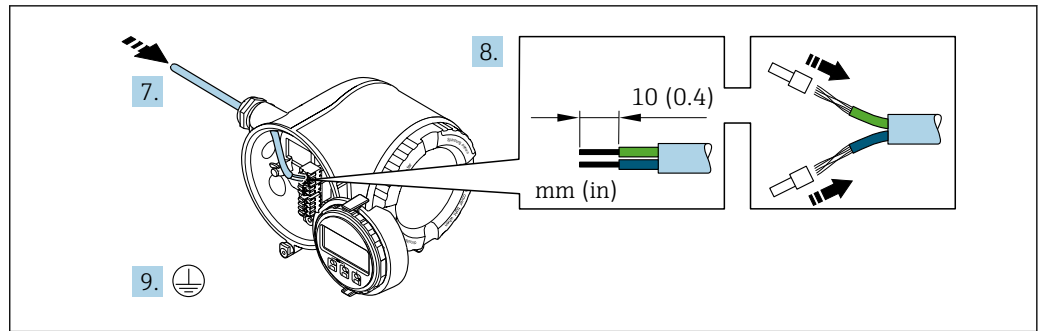

A0029815

7. Push the cable through the cable entry . To ensure tight sealing, do not remove the sealing ring from the cable entry.
8. Strip the cable and cable ends. In the case of stranded cables, also fit ferrules.
9. Connect the protective ground.

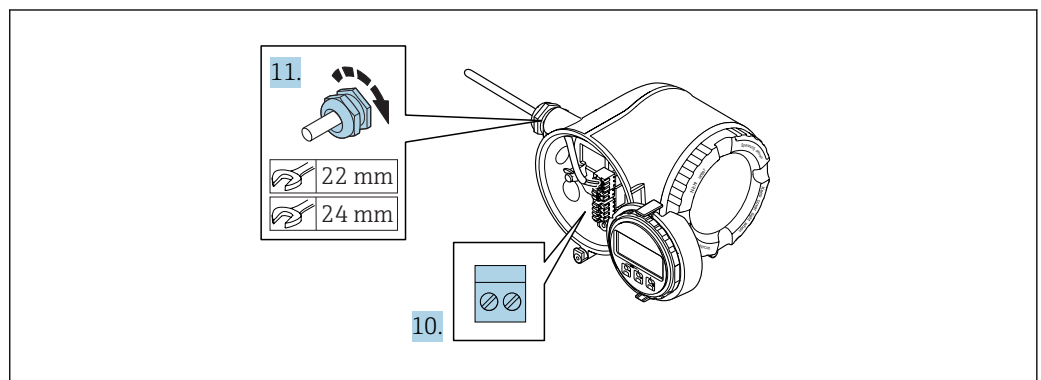

A0029816

10. Connect the cable in accordance with the terminal assignment .
 - ↳ **Signal cable terminal assignment:** The device-specific terminal assignment is documented on an adhesive label in the terminal cover.
 - Supply voltage terminal assignment:** Adhesive label in the terminal cover or → 39.
11. Firmly tighten the cable glands.
 - ↳ This concludes the cable connection process.
12. Close the terminal cover.
13. Fit the display module holder in the electronics compartment.
14. Screw on the connection compartment cover.
15. Secure the securing clamp of the connection compartment cover.

Removing a cable

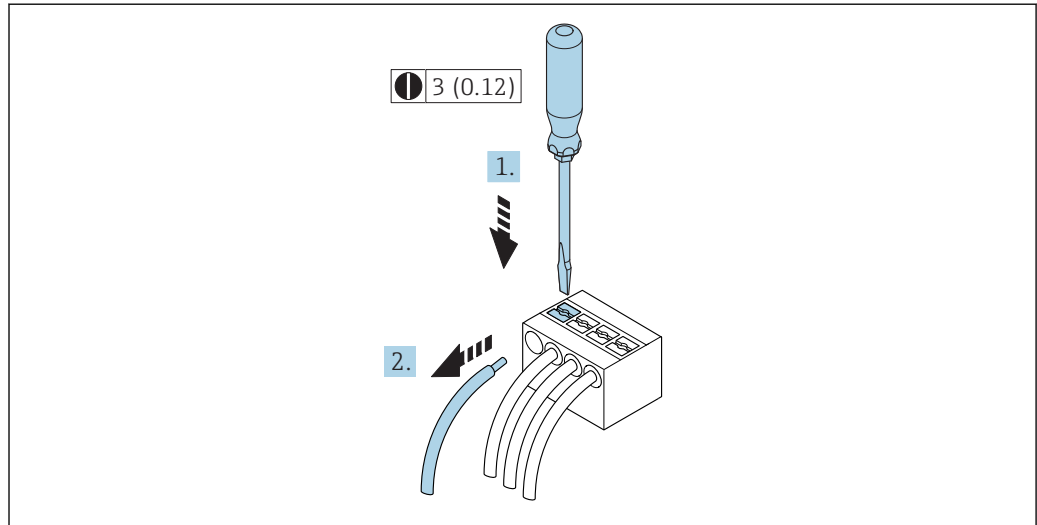

A0029598

15 Engineering unit mm (in)

1. To remove a cable from the terminal, use a flat-blade screwdriver to push the slot between the two terminal holes
2. while simultaneously pulling the cable end out of the terminal.

7.4 Ensure potential equalization

7.4.1 Requirements

No special measures for potential equalization are required.

7.5 Special connection instructions

7.5.1 Connection examples

Current output 4 to 20 mA HART

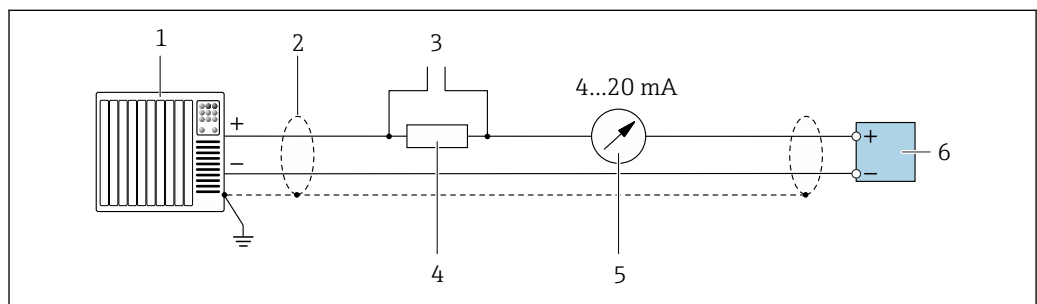

A0029055

16 Connection example for 4 to 20 mA HART current output (active)

- 1 Automation system with current input (e.g. PLC)
- 2 Cable shield: the cable shield must be grounded at both ends to comply with EMC requirements; observe cable specifications
- 3 Connection for HART operating devices → 81
- 4 Resistor for HART communication ($\geq 250 \Omega$): observe maximum load → 184
- 5 Analog display unit: observe maximum load → 184
- 6 Transmitter

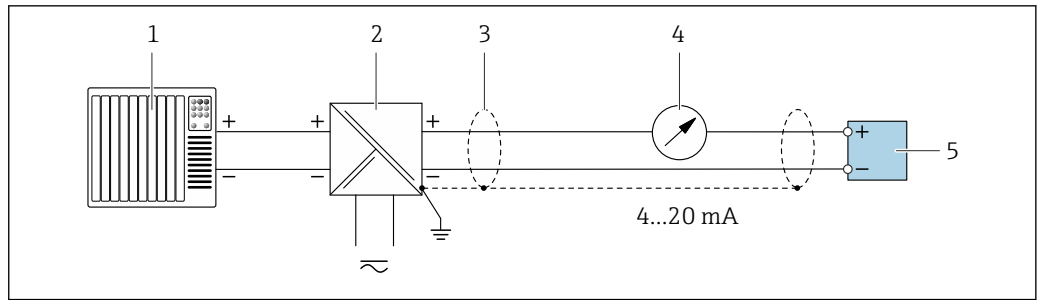

A0028762

17 Connection example for 4 to 20 mA HART current output (passive)

- 1 Automation system with current input (e.g. PLC)
- 2 Power supply
- 3 Cable shield: the cable shield must be grounded at both ends to comply with EMC requirements; observe cable specifications
- 4 Analog display unit: observe maximum load → 184
- 5 Transmitter

HART input

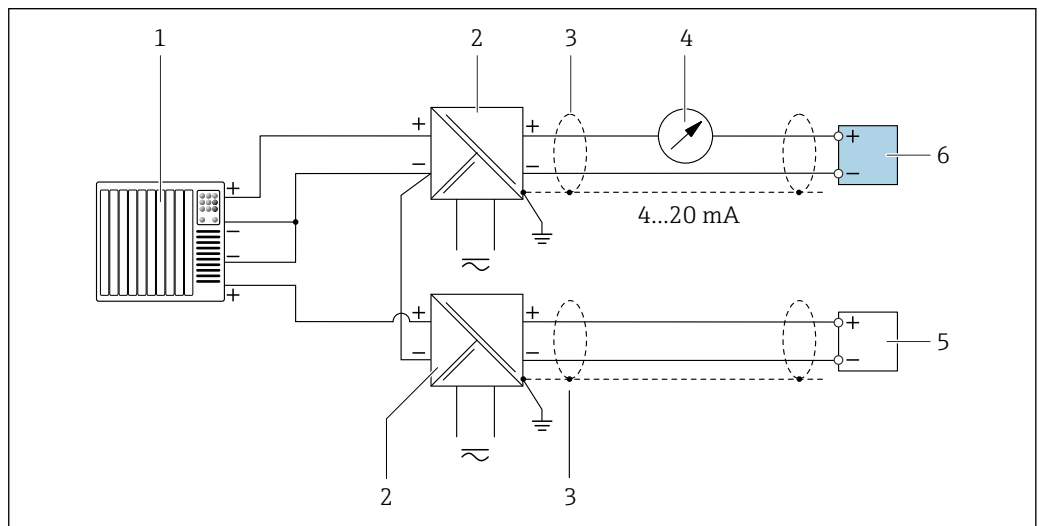

A0028763

18 Connection example for HART input with a common negative (passive)

- 1 Automation system with HART output (e.g. PLC)
- 2 Active barrier for power supply (e.g. RN221N)
- 3 Cable shield: the cable shield must be grounded at both ends to comply with EMC requirements; observe cable specifications
- 4 Analog display unit: observe maximum load
- 5 Pressure transmitter (e.g. Cerabar M, Cerabar S): see requirements
- 6 Transmitter

Current output 4-20 mA

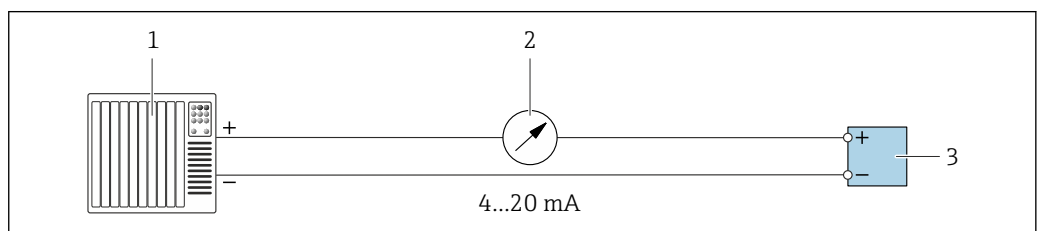

A0028758

19 Connection example for 4-20 mA current output (active)

- 1 Automation system with current input (e.g. PLC)
- 2 Analog display unit: observe maximum load
- 3 Transmitter

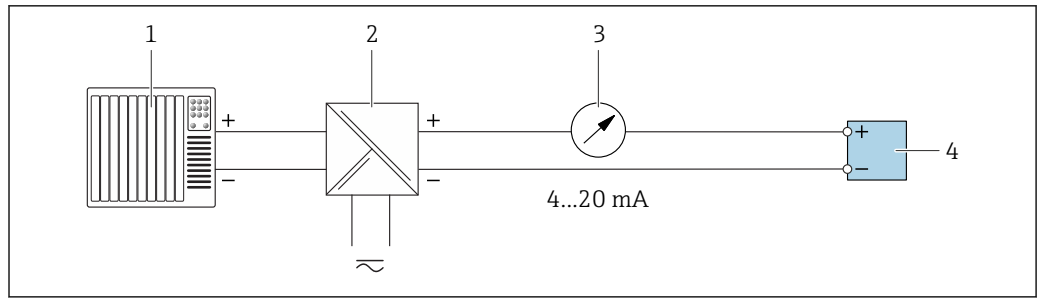

A0028759

20 Connection example for 4-20 mA current output (passive)

- 1 Automation system with current input (e.g. PLC)
- 2 Active barrier for power supply (e.g. RN221N)
- 3 Analog display unit: observe maximum load
- 4 Transmitter

Pulse/frequency output

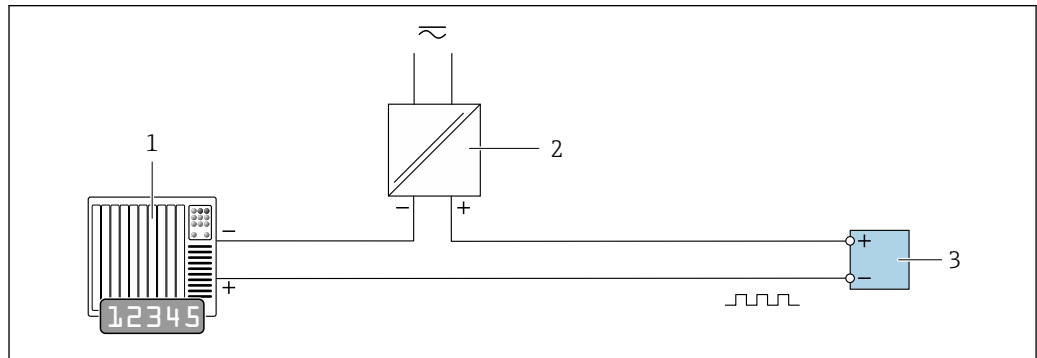

A0028761

21 Connection example for pulse/frequency output (passive)

- 1 Automation system with pulse/frequency input (e.g. PLC)
- 2 Power supply
- 3 Transmitter: Observe input values → 184

Switch output

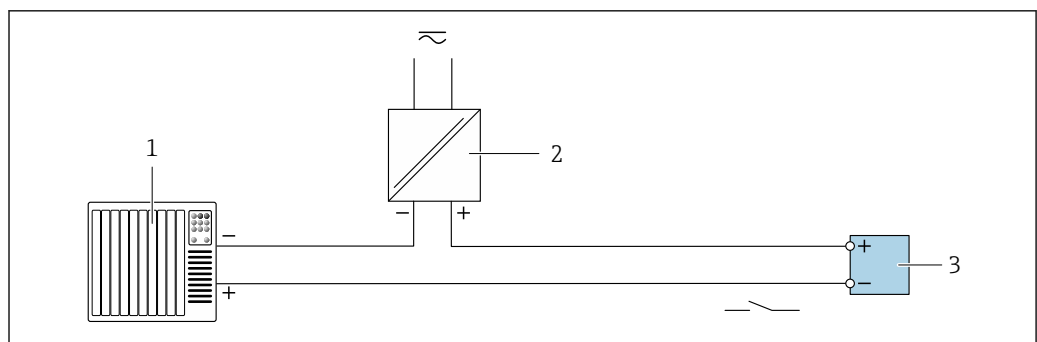

A0028760

22 Connection example for switch output (passive)

- 1 Automation system with switch input (e.g. PLC)
- 2 Power supply
- 3 Transmitter: Observe input values → 184

Double pulse output

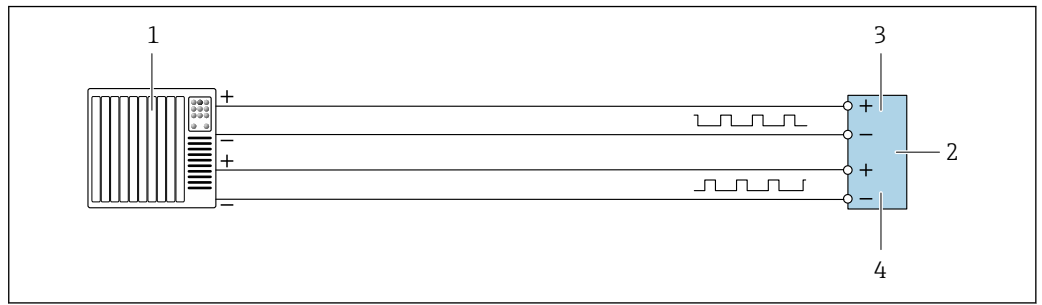

A0029280

23 Connection example for double pulse output (active)

- 1 Automation system with double pulse input (e.g. PLC)
- 2 Transmitter: Observe input values → 186
- 3 Double pulse output
- 4 Double pulse output (slave), phase-shifted

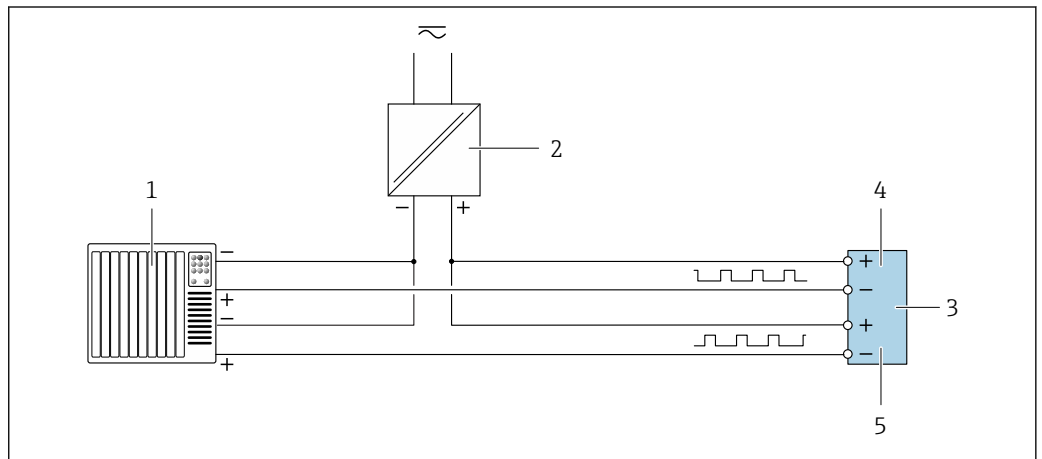

A0029279

24 Connection example for double pulse output (passive)

- 1 Automation system with double pulse input (e.g. PLC)
- 2 Power supply
- 3 Transmitter: Observe input values → 186
- 4 Double pulse output
- 5 Double pulse output (slave), phase-shifted

Relay output

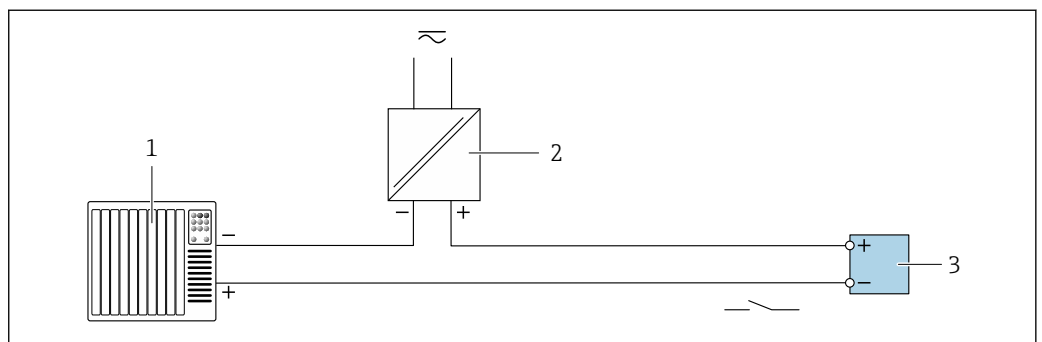

A0028760

25 Connection example for relay output (passive)

- 1 Automation system with relay input (e.g. PLC)
- 2 Power supply
- 3 Transmitter: Observe input values → 186

Current input

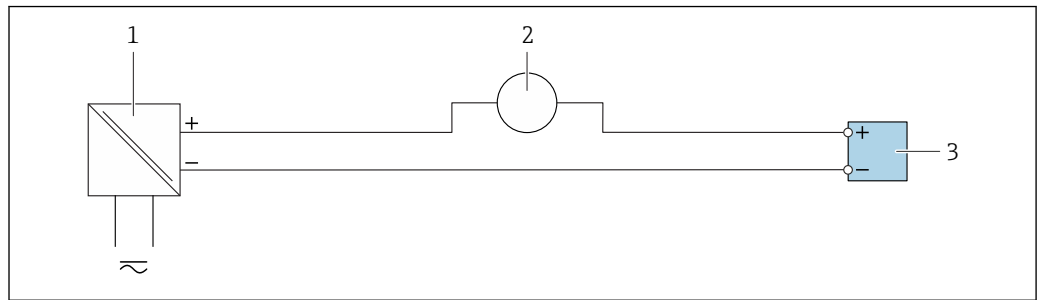

A0028915

26 Connection example for 4 to 20 mA current input

- 1 Power supply
- 2 External measuring device (for reading in pressure or temperature, for instance)
- 3 Transmitter: Observe input values

Status input

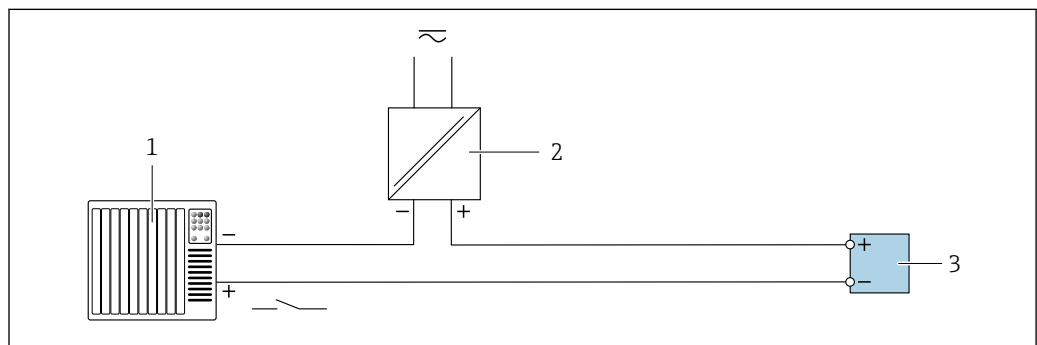

A0028764

27 Connection example for status input

- 1 Automation system with status output (e.g. PLC)
- 2 Power supply
- 3 Transmitter: Observe input values

7.6 Ensuring the degree of protection

The measuring device fulfills all the requirements for the IP66/67 degree of protection, Type 4X enclosure.

To guarantee IP66/67 degree of protection, Type 4X enclosure, carry out the following steps after the electrical connection:

1. Check that the housing seals are clean and fitted correctly.
2. Dry, clean or replace the seals if necessary.
3. Tighten all housing screws and screw covers.
4. Firmly tighten the cable glands.

- 5. To ensure that moisture does not enter the cable entry:
Route the cable so that it loops down before the cable entry ("water trap").

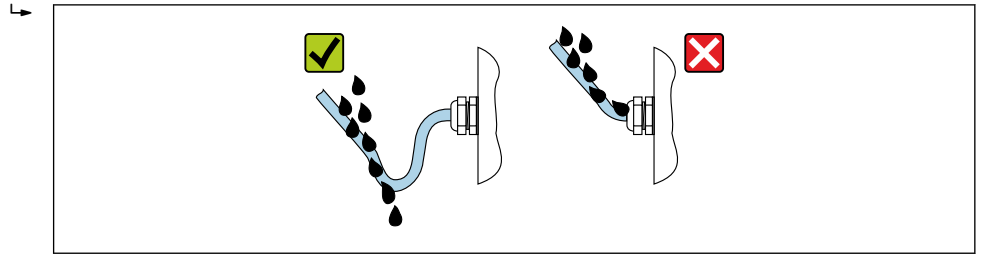

A0029278

- 6. Insert dummy plugs into unused cable entries.

7.7 Post-connection check

Are cables or the device undamaged (visual inspection)?	<input type="checkbox"/>
Do the cables used meet the requirements?	<input type="checkbox"/>
Do the cables have adequate strain relief?	<input type="checkbox"/>
Are all the cable glands installed, firmly tightened and leak-tight? Cable run with "water trap" → 58 ?	<input type="checkbox"/>

8 Operation options

8.1 Overview of operation options

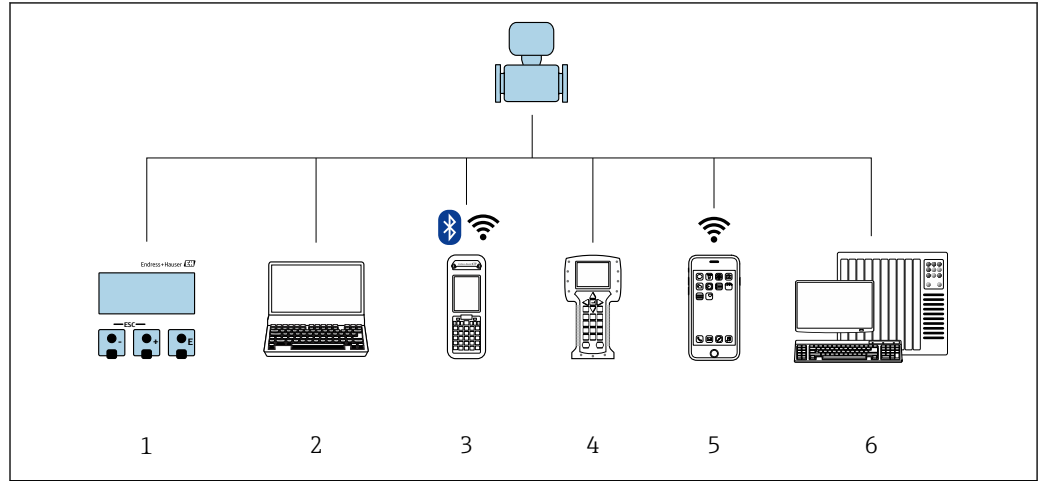



A0029295

- 1 Local operation via display module
- 2 Computer with Web browser (e.g. Internet Explorer) or with operating tool (e.g. FieldCare, DeviceCare, AMS Device Manager, SIMATIC PDM)
- 3 Field Xpert SFX350 or SFX370
- 4 Field Communicator 475
- 5 Mobile handheld terminal
- 6 Control system (e.g. PLC)

8.2 Structure and function of the operating menu

8.2.1 Structure of the operating menu

 For an overview of the operating menu for experts: "Description of Device Parameters" document supplied with the device →  207

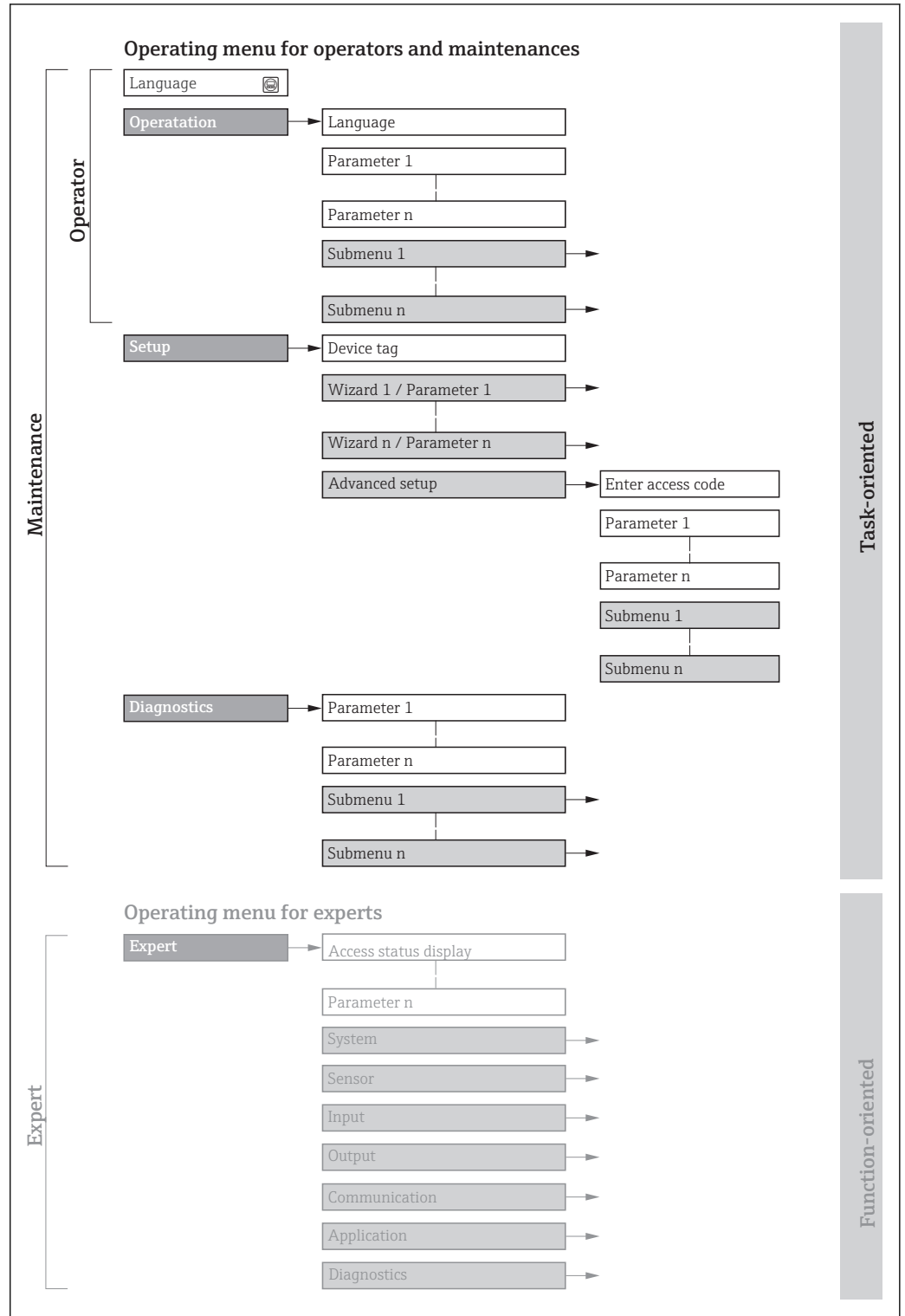

 28 Schematic structure of the operating menu

A0018237-EN

8.2.2 Operating philosophy

The individual parts of the operating menu are assigned to certain user roles (operator, maintenance etc.). Each user role contains typical tasks within the device lifecycle.

 For custody transfer, once the device has been put into circulation or sealed, its operation is restricted.

Menu/parameter		User role and tasks	Content/meaning
Language	task-oriented	Role "Operator", "Maintenance" Tasks during operation: <ul style="list-style-type: none"> ▪ Configuring the operational display ▪ Reading measured values 	<ul style="list-style-type: none"> ▪ Defining the operating language ▪ Defining the Web server operating language ▪ Resetting and controlling totalizers
Operation			<ul style="list-style-type: none"> ▪ Configuring the operational display (e.g. display format, display contrast) ▪ Resetting and controlling totalizers
Setup		"Maintenance" role Commissioning: <ul style="list-style-type: none"> ▪ Configuration of the measurement ▪ Configuration of the inputs and outputs ▪ Configuration of the communication interface 	Wizards for fast commissioning: <ul style="list-style-type: none"> ▪ Set the system units ▪ Configuration of the communication interface ▪ Define the medium ▪ Display I/O/configuration ▪ Configure the inputs ▪ Configure the outputs ▪ Configuring the operational display ▪ Define the output conditioning ▪ Set the low flow cut off ▪ Configure partial and empty pipe detection Advanced setup <ul style="list-style-type: none"> ▪ For more customized configuration of the measurement (adaptation to special measuring conditions) ▪ Configuration of totalizers ▪ Configure the WLAN settings ▪ Administration (define access code, reset measuring device)
Diagnostics	"Maintenance" role Fault elimination: <ul style="list-style-type: none"> ▪ Diagnostics and elimination of process and device errors ▪ Measured value simulation 	Contains all parameters for error detection and analyzing process and device errors: <ul style="list-style-type: none"> ▪ Diagnostic list Contains up to 5 currently pending diagnostic messages. ▪ Event logbook Contains event messages that have occurred. ▪ Device information Contains information for identifying the device. ▪ Measured values Contains all current measured values. ▪ Data logging submenu with "Extended HistoROM" order option Storage and visualization of measured values ▪ Heartbeat The functionality of the device is checked on demand and the verification results are documented. ▪ Simulation Is used to simulate measured values or output values. 	

Menu/parameter		User role and tasks	Content/meaning
Expert	function-oriented	<p>Tasks that require detailed knowledge of the function of the device:</p> <ul style="list-style-type: none"> ▪ Commissioning measurements under difficult conditions ▪ Optimal adaptation of the measurement to difficult conditions ▪ Detailed configuration of the communication interface ▪ Error diagnostics in difficult cases 	<p>Contains all the parameters of the device and makes it possible to access these parameters directly using an access code. The structure of this menu is based on the function blocks of the device:</p> <ul style="list-style-type: none"> ▪ System Contains all higher-order device parameters which do not concern the measurement or the communication interface. ▪ Sensor Configuration of the measurement. ▪ Input Configuring the status input. ▪ Output Configuring of the analog current outputs as well as the pulse/frequency and switch output. ▪ Communication Configuration of the digital communication interface and the Web server. ▪ Application Configure the functions that go beyond the actual measurement (e.g. totalizer). ▪ Diagnostics Error detection and analysis of process and device errors and for device simulation and Heartbeat Technology.

8.3 Access to the operating menu via the local display

8.3.1 Operational display

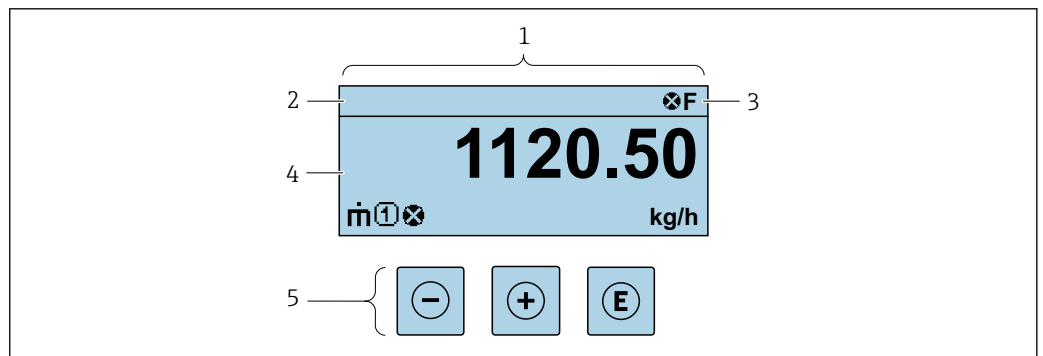

A0029346

- 1 Operational display
- 2 Device tag
- 3 Status area
- 4 Display area for measured values (4-line)
- 5 Operating elements → 68

Status area

The following symbols appear in the status area of the operational display at the top right:







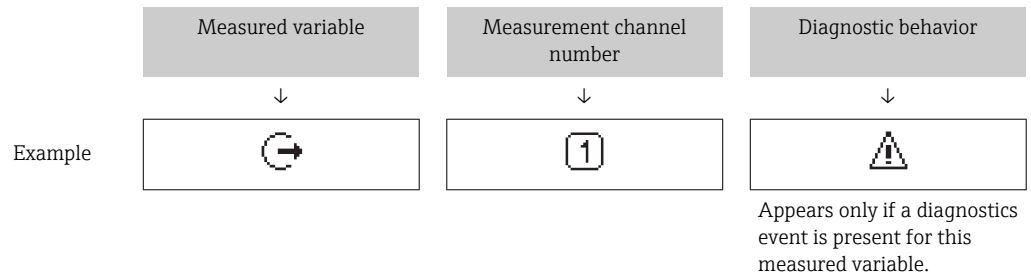

- Status signals → 157
 - F: Failure
 - C: Function check
 - S: Out of specification
 - M: Maintenance required
- Diagnostic behavior → 158
 - ☒: Alarm
 - ⚠: Warning
- 🔒: Locking (the device is locked via the hardware)
- ↔: Communication (communication via remote operation is active)

Display area

In the display area, each measured value is prefaced by certain symbol types for further description:



Measured values



Symbol	Meaning
	Mass flow
	<ul style="list-style-type: none"> ▪ Volume flow ▪ Corrected volume flow
	<ul style="list-style-type: none"> ▪ Density ▪ Reference density
	Temperature
	Totalizer  The measurement channel number indicates which of the three totalizers is displayed.
	Output  The measurement channel number indicates which of the outputs is displayed.
	Status input

Measurement channel numbers

Symbol	Meaning
	Measurement channel 1 to 4
The measurement channel number is displayed only if more than one channel is present for the same measured variable type (e.g. Totalizer 1 to 3).	

Diagnostic behavior

The diagnostic behavior pertains to a diagnostic event that is relevant to the displayed measured variable. For information on the symbols →  158

 The number and display format of the measured values can be configured via the **"Format display" parameter** →  116. Operation → Display → Format display

8.3.2 Navigation view

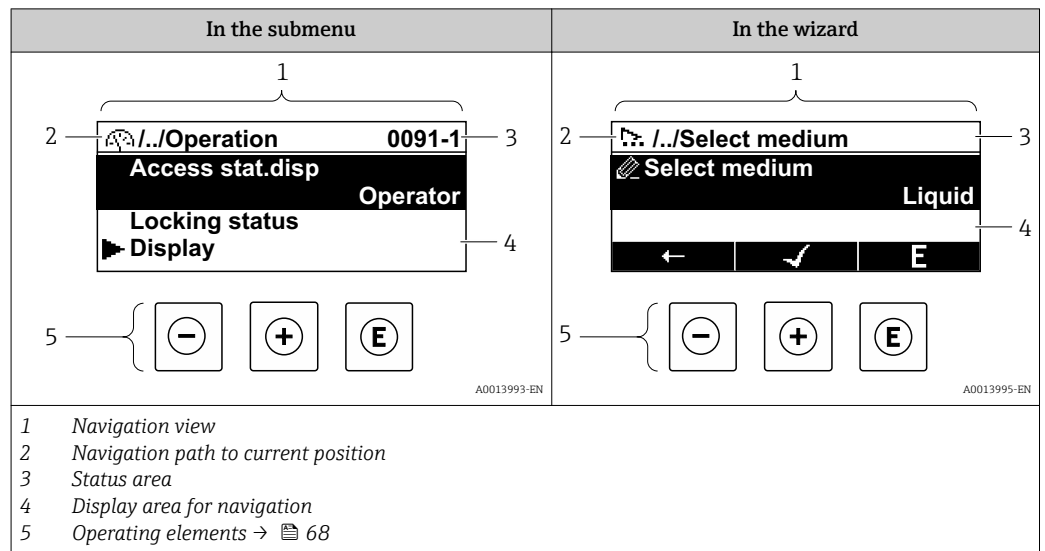

Navigation path

The navigation path - displayed at the top left in the navigation view - consists of the following elements:

	<ul style="list-style-type: none"> In the submenu: Display symbol for menu In the wizard: Display symbol for wizard 	Omission symbol for operating menu levels in between	Name of current <ul style="list-style-type: none"> Submenu Wizard Parameters
Examples	↓ 	↓ / .. /	↓ Display
		/ .. /	Display

For more information about the icons in the menu, refer to the "Display area" section → 66

Status area





The following appears in the status area of the navigation view in the top right corner:

- In the submenu
 - The direct access code for the parameter you are navigating to (e.g. 0022-1)
 - If a diagnostic event is present, the diagnostic behavior and status signal
- In the wizard
 - If a diagnostic event is present, the diagnostic behavior and status signal





- For information on the diagnostic behavior and status signal → 157
- For information on the function and entry of the direct access code → 71

Display area

Menus

Symbol	Meaning
	Operation Appears: <ul style="list-style-type: none"> In the menu next to the "Operation" selection At the left in the navigation path in the Operation menu
	Setup Appears: <ul style="list-style-type: none"> In the menu next to the "Setup" selection At the left in the navigation path in the Setup menu
	Diagnostics Appears: <ul style="list-style-type: none"> In the menu next to the "Diagnostics" selection At the left in the navigation path in the Diagnostics menu
	Expert Appears: <ul style="list-style-type: none"> In the menu next to the "Expert" selection At the left in the navigation path in the Expert menu



Submenus, wizards, parameters

Symbol	Meaning
	Submenu
	Wizard
	Parameters within a wizard  No display symbol exists for parameters in submenus.

Locking

Symbol	Meaning
	Parameter locked When displayed in front of a parameter name, indicates that the parameter is locked. <ul style="list-style-type: none"> By a user-specific access code By the hardware write protection switch

Wizard operation

Symbol	Meaning
	Switches to the previous parameter.
	Confirms the parameter value and switches to the next parameter.
	Opens the editing view of the parameter.

8.3.3 Editing view

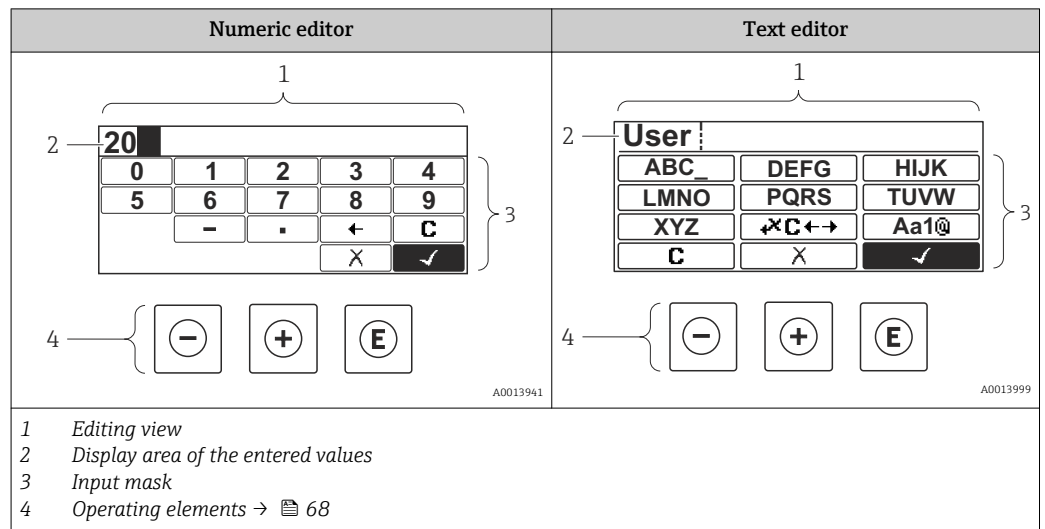

Input mask









The following input symbols are available in the input mask of the numeric and text editor:

Numeric editor





Symbol	Meaning
0 ... 9	Selection of numbers from 0 to 9.
.	Inserts decimal separator at the input position.
-	Inserts minus sign at the input position.
✓	Confirms selection.
←	Moves the input position one position to the left.
X	Exits the input without applying the changes.
C	Clears all entered characters.

Text editor



Symbol	Meaning
Aa1@ ... XYZ	Toggle <ul style="list-style-type: none"> Between upper-case and lower-case letters For entering numbers For entering special characters
ABC_ ... XYZ	Selection of letters from A to Z.

 	Selection of letters from a to z.
 	Selection of special characters.
	Confirms selection.
	Switches to the selection of the correction tools.
	Exits the input without applying the changes.
	Clears all entered characters.

Correction symbols under 

Symbol	Meaning
	Clears all entered characters.
	Moves the input position one position to the right.
	Moves the input position one position to the left.
	Deletes one character immediately to the left of the input position.

8.3.4 Operating elements

Key	Meaning
	<p>Minus key</p> <p><i>In a menu, submenu</i> Moves the selection bar upwards in a choose list.</p> <p><i>With a Wizard</i> Confirms the parameter value and goes to the previous parameter.</p> <p><i>With a text and numeric editor</i> In the input mask, moves the selection bar to the left (backwards).</p>
	<p>Plus key</p> <p><i>In a menu, submenu</i> Moves the selection bar downwards in a choose list.</p> <p><i>With a Wizard</i> Confirms the parameter value and goes to the next parameter.</p> <p><i>With a text and numeric editor</i> Moves the selection bar to the right (forwards) in an input screen.</p>

Key	Meaning
ⓔ	<p>Enter key</p> <p><i>For operational display</i></p> <ul style="list-style-type: none"> Pressing the key briefly opens the operating menu. Pressing the key for 2 s opens the context menu. <p><i>In a menu, submenu</i></p> <ul style="list-style-type: none"> Pressing the key briefly: <ul style="list-style-type: none"> Opens the selected menu, submenu or parameter. Starts the wizard. If help text is open, closes the help text of the parameter. Pressing the key for 2 s for parameter: <ul style="list-style-type: none"> If present, opens the help text for the function of the parameter. <p><i>With a Wizard</i></p> <p>Opens the editing view of the parameter.</p> <p><i>With a text and numeric editor</i></p> <ul style="list-style-type: none"> Pressing the key briefly: <ul style="list-style-type: none"> Opens the selected group. Carries out the selected action. Pressing the key for 2 s confirms the edited parameter value.
Ⓜ + ⓕ	<p>Escape key combination (press keys simultaneously)</p> <p><i>In a menu, submenu</i></p> <ul style="list-style-type: none"> Pressing the key briefly: <ul style="list-style-type: none"> Exits the current menu level and takes you to the next higher level. If help text is open, closes the help text of the parameter. Pressing the key for 2 s returns you to the operational display ("home position"). <p><i>With a Wizard</i></p> <p>Exits the wizard and takes you to the next higher level.</p> <p><i>With a text and numeric editor</i></p> <p>Closes the text or numeric editor without applying changes.</p>
Ⓜ + ⓔ	<p>Minus/Enter key combination (press the keys simultaneously)</p> <p>Reduces the contrast (brighter setting).</p>
ⓕ + ⓔ	<p>Plus/Enter key combination (press and hold down the keys simultaneously)</p> <p>Increases the contrast (darker setting).</p>
Ⓜ + ⓕ + ⓔ	<p>Minus/Plus/Enter key combination (press the keys simultaneously)</p> <p><i>For operational display</i></p> <p>Enables or disables the keypad lock (only SD02 display module).</p>

8.3.5 Opening the context menu

Using the context menu, the user can call up the following menus quickly and directly from the operational display:

- Setup
- Data backup
- Simulation

Calling up and closing the context menu

The user is in the operational display.

- Press ⓔ for 2 s.
 - The context menu opens.

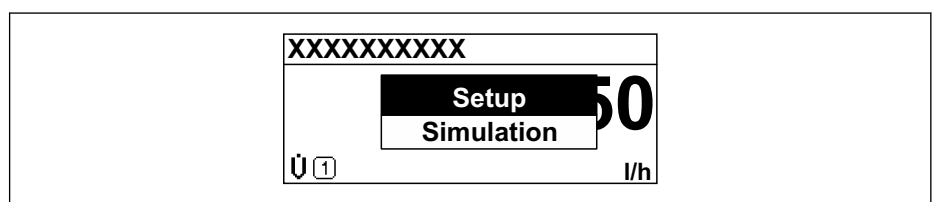

A0017421-EN

2. Press \square + \boxplus simultaneously.
 - ↳ The context menu is closed and the operational display appears.

Calling up the menu via the context menu

1. Open the context menu.
2. Press \boxplus to navigate to the desired menu.
3. Press \boxtimes to confirm the selection.
 - ↳ The selected menu opens.

8.3.6 Navigating and selecting from list

Different operating elements are used to navigate through the operating menu. The navigation path is displayed on the left in the header. Icons are displayed in front of the individual menus. These icons are also shown in the header during navigation.

i For an explanation of the navigation view with symbols and operating elements → 65

Example: Setting the number of displayed measured values to "2 values"

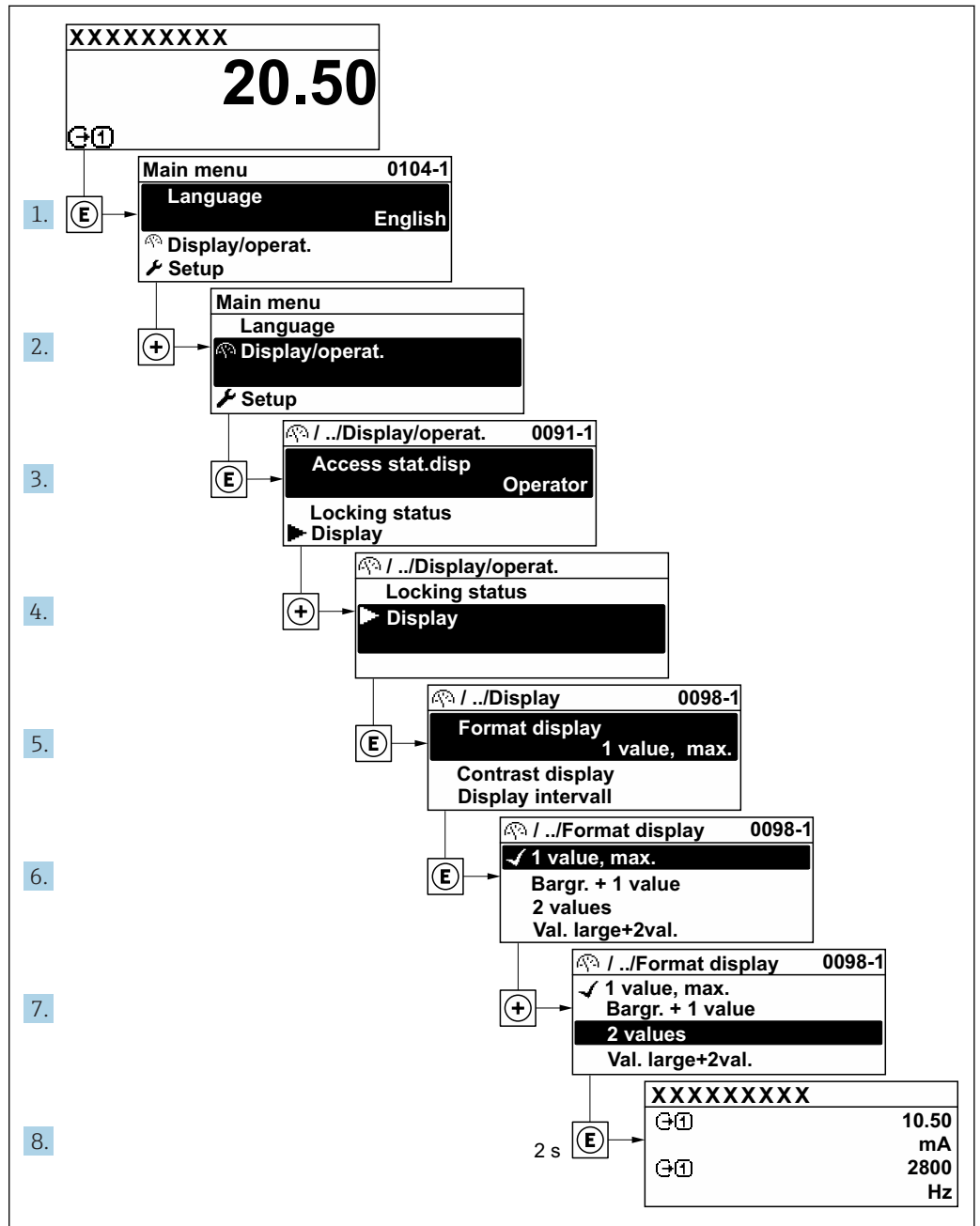

A0029562-EN

8.3.7 Calling the parameter directly

A parameter number is assigned to every parameter to be able to access a parameter directly via the onsite display. Entering this access code in the **Direct access** parameter calls up the desired parameter directly.

Navigation path

Expert → Direct access

The direct access code consists of a 4-digit number and the channel number, which identifies the channel of a process variable: e.g. 0914-1. In the navigation view, this appears on the right-hand side in the header of the selected parameter.

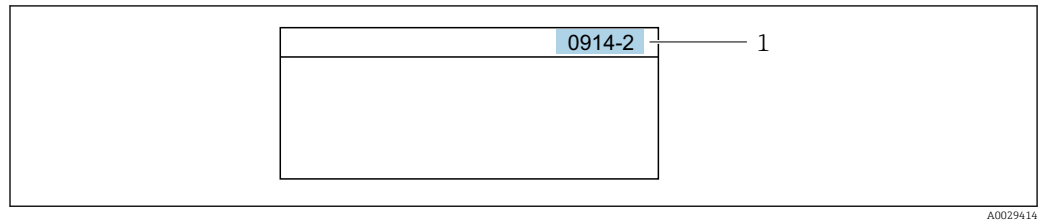

1 Direct access code

Note the following when entering the direct access code:

- The leading zeros in the direct access code do not have to be entered.
Example: Input of "914" instead of "0914"
- If no channel number is entered, channel 1 is jumped to automatically.
Example: Enter 0914 → **Assign process variable** parameter
- If a different channel is jumped to: Enter the direct access code with the corresponding channel number.
Example: Enter 0914-2 → **Assign process variable** parameter

 For the direct access codes of the individual parameters, see the "Description of Device Parameters" document for the device

8.3.8 Calling up help text

Help text is available for some parameters and can be called up from the navigation view. The help text provides a brief explanation of the parameter function and thereby supports swift and safe commissioning.



Calling up and closing the help text

The user is in the navigation view and the selection bar is on a parameter.

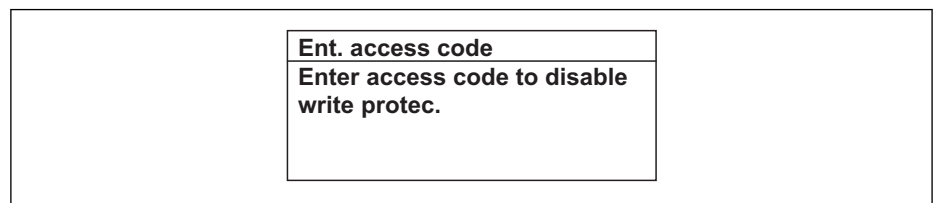
1. Press  for 2 s.
↳ The help text for the selected parameter opens.



 29 Example: Help text for parameter "Enter access code"

2. Press  +  simultaneously.
↳ The help text is closed.

8.3.9 Changing the parameters

i For a description of the editing display - consisting of text editor and numeric editor - with symbols → 67, for a description of the operating elements → 68

Example: Changing the tag name in the "Tag description" parameter from 001-FT-101 to 001-FT-102

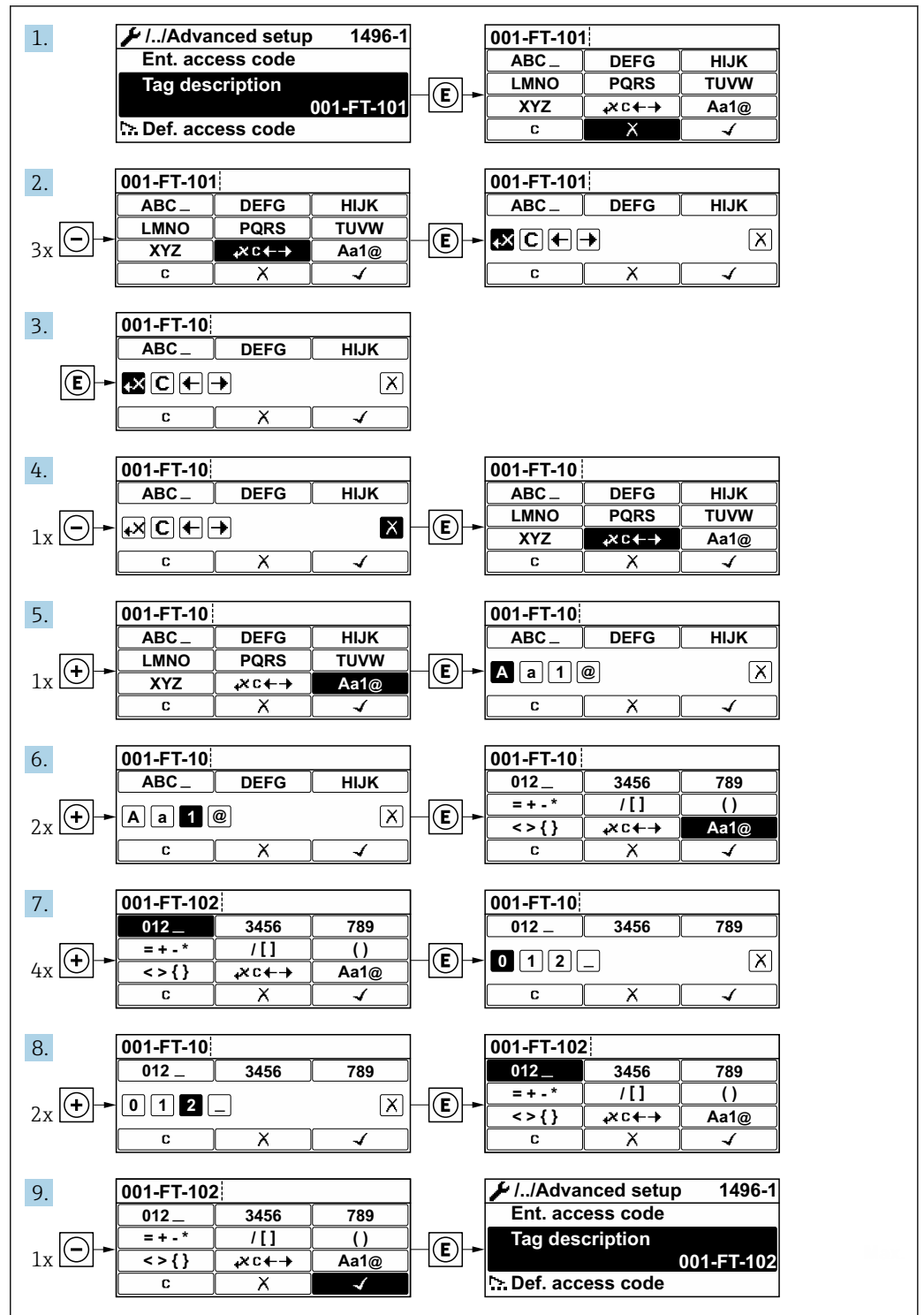

A0029563-EN

A message is displayed if the value entered is outside the permitted value range.

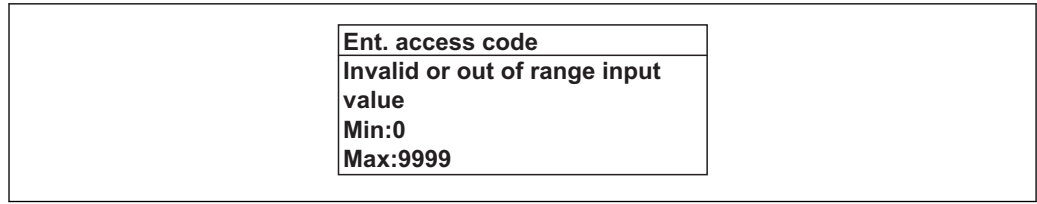

A0014049-EN

8.3.10 User roles and related access authorization

The two user roles "Operator" and "Maintenance" have different write access to the parameters if the customer defines a user-specific access code. This protects the device configuration via the local display from unauthorized access → 136.

Access authorization to parameters: "Operator" user role

Access code status	Read access	Write access
An access code has not yet been defined (factory setting).	✓	✓
After an access code has been defined.	✓	-- 1)

- 1) Despite the defined access code, certain parameters can always be modified and thus are excepted from the write protection, as they do not affect the measurement. Refer to the "Write protection via access code" section

Access authorization to parameters: "Maintenance" user role

Access code status	Read access	Write access
An access code has not yet been defined (factory setting).	✓	✓
After an access code has been defined.	✓	✓ 1)

- 1) If an incorrect access code is entered, the user obtains the access rights of the "Operator" user role.

The user role with which the user is currently logged on is indicated by the **Access status** parameter. Navigation path: Operation → Access status

8.3.11 Disabling write protection via access code

If the -symbol appears on the local display in front of a parameter, the parameter is write-protected by a user-specific access code and its value cannot be changed at the moment using local operation → 136.

Parameter write protection via local operation can be disabled by entering the user-specific access code in the **Enter access code** parameter (→ 122) via the respective access option.

1. After you press , the input prompt for the access code appears.
2. Enter the access code.
 - ↳ The -symbol in front of the parameters disappears; all previously write-protected parameters are now re-enabled.

8.3.12 Enabling and disabling the keypad lock

The keypad lock makes it possible to block access to the entire operating menu via local operation. As a result, it is no longer possible to navigate through the operating menu or change the values of individual parameters. Users can only read the measured values on the operational display.

Local operation with touch control

The keypad lock is switched on and off via the context menu.

Switching on the keypad lock

The keypad lock is switched on automatically:

- Each time the device is restarted.
- If the device has not been operated for longer than one minute in the measured value display.

1. The device is in the measured value display.
Press  for at least 2 seconds.
↳ A context menu appears.
2. In the context menu, select the **Keylock on** option.
↳ The keypad lock is switched on.

 If the user attempts to access the operating menu while the keypad lock is active, the message **Keylock on** appears.



Switching off the keypad lock

1. The keypad lock is switched on.
Press  for at least 2 seconds.
↳ A context menu appears.
2. In the context menu, select the **Keylock off** option.
↳ The keypad lock is switched off.

8.4 Access to the operating menu via the Web browser

8.4.1 Function range

Thanks to the integrated Web server, the device can be operated and configured via a Web browser and via a service interface (CDI-RJ45) or a WLAN interface. The structure of the operating menu is the same as for the local display. In addition to the measured values, status information on the device is also displayed and allows the user to monitor the status of the device. Furthermore the measuring device data can be managed and the network parameters can be configured. The WLAN connection requires a device that acts as an access point to enable communication via a computer or mobile handheld terminal.

 For additional information on the Web server, refer to the Special Documentation for the device →  208

8.4.2 Prerequisites



Computer hardware

Hardware	Interface	
	CDI-RJ45	WLAN
Interface	The computer must have an RJ45 interface.	The operating unit must have a WLAN interface.
Connection	Standard Ethernet cable with RJ45 connector.	Connection via Wireless LAN.
Screen	Recommended size: ≥12" (depends on the screen resolution)	

Computer software





Software	Interface	
	CDI-RJ45	WLAN
Recommended operating systems	<ul style="list-style-type: none"> ▪ Microsoft Windows 7 or higher. ▪ Mobile operating systems: <ul style="list-style-type: none"> - iOS - Android <p> Microsoft Windows XP is supported.</p>	
Web browsers supported	<ul style="list-style-type: none"> ▪ Microsoft Internet Explorer 8 or higher ▪ Microsoft Edge ▪ Mozilla Firefox ▪ Google Chrome ▪ Safari 	

Computer settings

Settings	Interface	
	CDI-RJ45	WLAN
User rights	Appropriate user rights (e.g. administrator rights) for TCP/IP and proxy server settings are necessary (for adjusting the IP address, subnet mask etc.).	
Proxy server settings of the Web browser	The Web browser setting <i>Use a Proxy Server for Your LAN</i> must be deselected .	
JavaScript	<p>JavaScript must be enabled.</p> <p> If JavaScript cannot be enabled: enter <code>http://192.168.1.212/basic.html</code> in the address line of the Web browser. A fully functional but simplified version of the operating menu structure starts in the Web browser.</p> <p> When installing a new firmware version: To enable correct data display, clear the temporary memory (cache) of the Web browser under Internet options.</p>	
Network connections	Only the active network connections to the measuring device should be used.	
	Switch off all other network connections such as WLAN.	Switch off all other network connections.

 In the event of connection problems: →  152

Measuring device

Device	Interface	
	CDI-RJ45	WLAN
Measuring device	The measuring device has an RJ45 interface.	The measuring device has a WLAN antenna: <ul style="list-style-type: none"> ▪ Transmitter with integrated WLAN antenna ▪ Transmitter with external WLAN antenna
Web server	<p>Web server must be enabled; factory setting: ON</p> <p> For information on enabling the Web server →  80</p>	<p>Web server and WLAN must be enabled; factory setting: ON</p> <p> For information on enabling the Web server →  80</p>

8.4.3 Establishing a connection

Via service interface (CDI-RJ45)

Configuring the Internet protocol of the computer

The following information refers to the default Ethernet settings of the device.

IP address of the device: 192.168.1.212 (factory setting)

1. Switch on the measuring device.
2. Connect to the computer using a cable →  82.
3. If a 2nd network card is not used, close all the applications on the notebook.
 - ↳ Applications requiring Internet or a network, such as e-mail, SAP applications, Internet or Windows Explorer.
4. Close any open Internet browsers.
5. Configure the properties of the Internet protocol (TCP/IP) as defined in the table:

IP address	192.168.1.XXX; for XXX all numerical sequences except: 0, 212 and 255 → e.g. 192.168.1.213
Subnet mask	255.255.255.0
Default gateway	192.168.1.212 or leave cells empty

Via WLAN interface

Configuring the Internet protocol of the operating unit

NOTICE

If the WLAN connection is lost during the configuration, settings made may be lost.

- ▶ Make sure that the WLAN connection is not disconnected while configuring the device.

NOTICE

In principle, avoid simultaneous access to the measuring device via the service interface (CDI-RJ45) and the WLAN interface from the same operating unit. This could cause a network conflict.

- ▶ Only activate one service interface (CDI-RJ45 service interface or WLAN interface).
- ▶ If simultaneous communication is necessary: configure different IP address ranges, e.g. 192.168.0.1 (WLAN interface) and 192.168.1.212 (CDI-RJ45 service interface).

Preparation

- ▶ Enable WLAN reception on the operating unit.

Establishing a connection

1. Select the measuring device using the SSID (e.g. EH_Promass_500_A802000).
2. If necessary, select the WPA2 encryption method.
3. Enter the password: serial number of the measuring device ex-works (e.g. L100A802000).
 - ↳ LED on display module flashes: it is now possible to operate the measuring device with the Web browser, FieldCare or DeviceCare.

 The serial number can be found on the nameplate.

Disconnecting

- ▶ Once the configuration is completed, disconnect the WLAN connection between the operating unit and the measuring device.

Starting the Web browser

1. Start the Web browser on the computer.
2. Enter the IP address of the Web server in the address line of the Web browser:
192.168.1.212
↳ The login page appears.

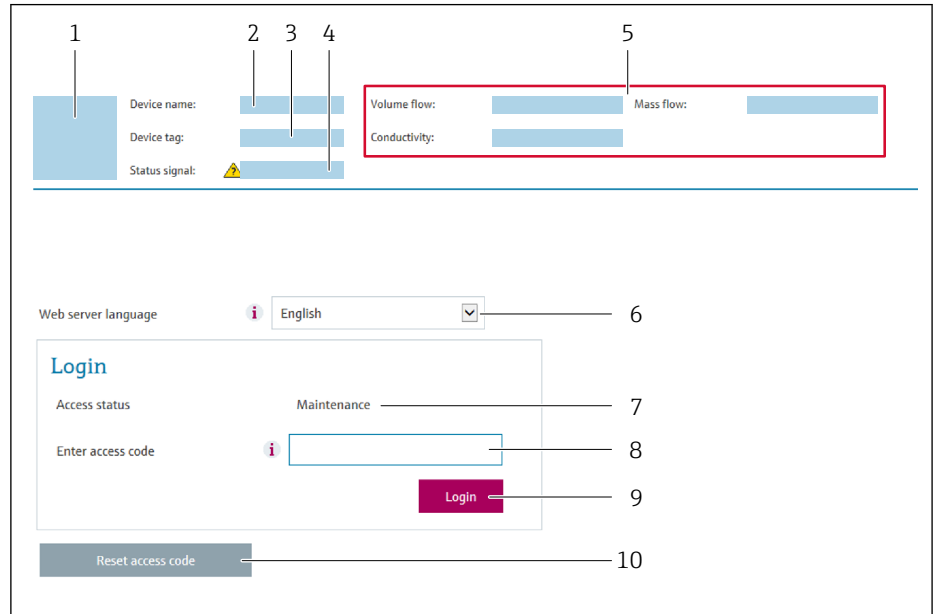

A0029417

- 1 Picture of device
- 2 Device name
- 3 Device tag (→ ⓘ 94)
- 4 Status signal
- 5 Current measured values
- 6 Operating language
- 7 User role
- 8 Access code
- 9 Login
- 10 Reset access code (→ ⓘ 133)

i If a login page does not appear, or if the page is incomplete → ⓘ 152

8.4.4 Logging on

1. Select the preferred operating language for the Web browser.
2. Enter the user-specific access code.
3. Press **OK** to confirm your entry.

Access code	0000 (factory setting); can be changed by customer
--------------------	--

i If no action is performed for 10 minutes, the Web browser automatically returns to the login page.

8.4.5 User interface

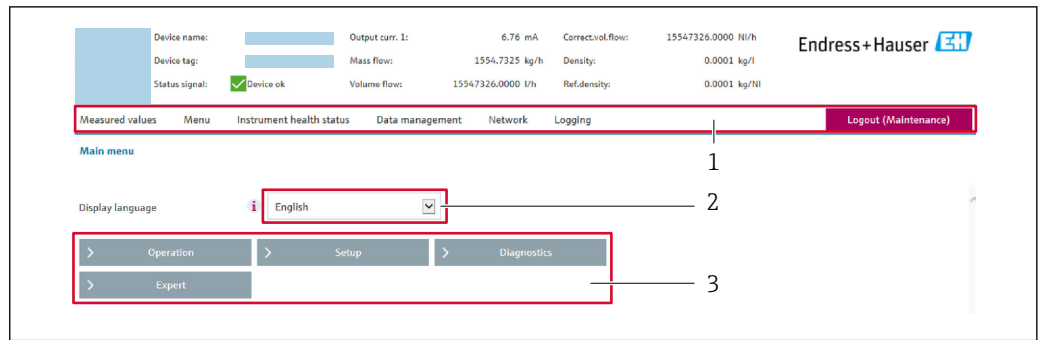

A0029418

- 1 Function row
- 2 Operating language
- 3 Navigation area

Header

The following information appears in the header:

- Device tag
- Device status with status signal → 📄 160
- Current measured values

Function row

Functions	Meaning
Measured values	Displays the measured values of the measuring device
Menu	<ul style="list-style-type: none"> ■ Access to the operating menu from the measuring device ■ The structure of the operating menu is the same as for the local display  For detailed information on the structure of the operating menu, see the Operating Instructions for the measuring device
Device status	Displays the diagnostic messages currently pending, listed in order of priority
Data management	<ul style="list-style-type: none"> ■ Data exchange between PC and measuring device: <ul style="list-style-type: none"> - Load the configuration from the measuring device (XML format, save configuration) - Save the configuration to the measuring device (XML format, restore configuration) - Export the event list (.csv file) - Export parameter settings (.csv file, create documentation of the measuring point configuration) - Export the Heartbeat verification log (PDF file, only available with the "Heartbeat Verification" application package) ■ If using fieldbuses, upload device drivers for system integration from the measuring device: <ul style="list-style-type: none"> HART: DD file ■ Flashing a firmware version
Network configuration	Configuration and checking of all the parameters required for establishing the connection to the measuring device: <ul style="list-style-type: none"> ■ Network settings (e.g. IP address, MAC address) ■ Device information (e.g. serial number, firmware version)
Logout	End the operation and call up the login page

Navigation area

If a function is selected in the function bar, the submenus of the function open in the navigation area. The user can now navigate through the menu structure.

Working area

Depending on the selected function and the related submenus, various actions can be performed in this area:

- Configuring parameters
- Reading measured values
- Calling up help text
- Starting an upload/download

8.4.6 Disabling the Web server

The Web server of the measuring device can be switched on and off as required using the **Web server functionality** parameter.

Navigation

"Expert" menu → Communication → Web server

Parameter overview with brief description

Parameter	Description	Selection	Factory setting
Web server functionality	Switch the Web server on and off.	<ul style="list-style-type: none"> ▪ Off ▪ On 	On

Function scope of the "Web server functionality" parameter

Option	Description
Off	<ul style="list-style-type: none"> ▪ The web server is completely disabled. ▪ Port 80 is locked.
On	<ul style="list-style-type: none"> ▪ The complete functionality of the web server is available. ▪ JavaScript is used. ▪ The password is transferred in an encrypted state. ▪ Any change to the password is also transferred in an encrypted state.

Enabling the Web server

If the Web server is disabled it can only be re-enabled with the **Web server functionality** parameter via the following operating options:

- Via local display
- Via Bedientool "FieldCare"
- Via "DeviceCare" operating tool

8.4.7 Logging out

 Before logging out, perform a data backup via the **Data management** function (upload configuration from device) if necessary.

1. Select the **Logout** entry in the function row.
↳ The home page with the Login box appears.
2. Close the Web browser.
3. Reset the modified properties of the Internet protocol (TCP/IP) if they are no longer needed →  77.

8.5 Access to the operating menu via the operating tool

The structure of the operating menu in the operating tools is the same as for operation via the local display.

8.5.1 Connecting the operating tool

Via HART protocol

This communication interface is available in device versions with a HART output.

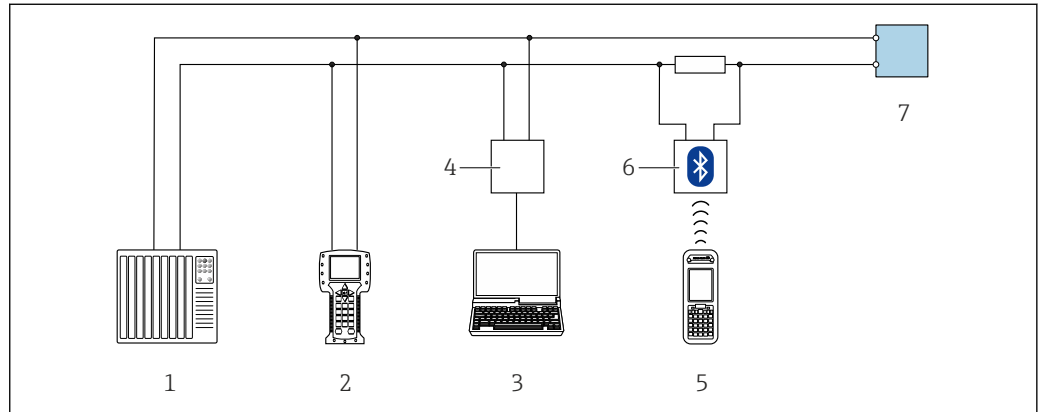

A0028747

30 Options for remote operation via HART protocol (active)

- 1 Control system (e.g. PLC)
- 2 Field Communicator 475
- 3 Computer with Web browser (e.g. Internet Explorer) for accessing the integrated device Web server or computer with operating tool (e.g. FieldCare, DeviceCare, AMS Device Manager, SIMATIC PDM) with COM DTM "CDI Communication TCP/IP"
- 4 Commubox FXA195 (USB)
- 5 Field Xpert SFX350 or SFX370
- 6 VIATOR Bluetooth modem with connecting cable
- 7 Transmitter

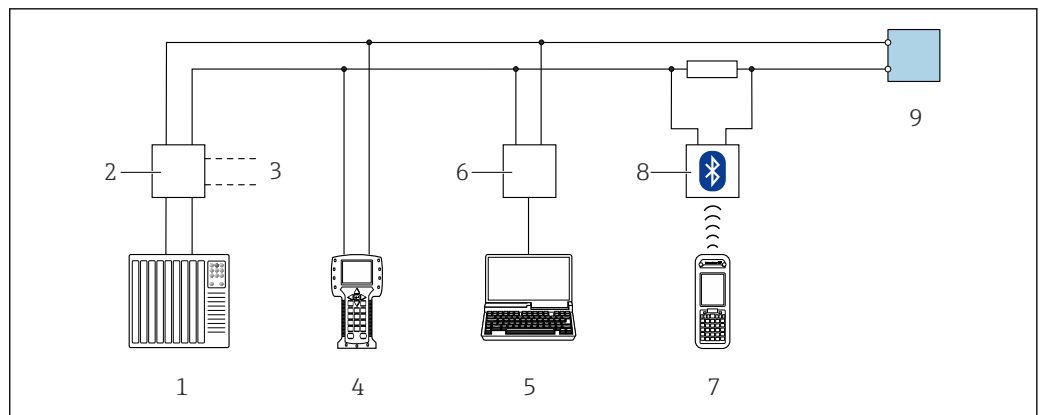

A0028746

31 Options for remote operation via HART protocol (passive)

- 1 Control system (e.g. PLC)
- 2 Transmitter power supply unit, e.g. RN221N (with communication resistor)
- 3 Connection for Commubox FXA195 and Field Communicator 475
- 4 Field Communicator 475
- 5 Computer with Web browser (e.g. Internet Explorer) for accessing the integrated device Web server or computer with operating tool (e.g. FieldCare, DeviceCare, AMS Device Manager, SIMATIC PDM) with COM DTM "CDI Communication TCP/IP"
- 6 Commubox FXA195 (USB)
- 7 Field Xpert SFX350 or SFX370
- 8 VIATOR Bluetooth modem with connecting cable
- 9 Transmitter

Service interface

Via service interface (CDI-RJ45)

Proline 500 – digital transmitter

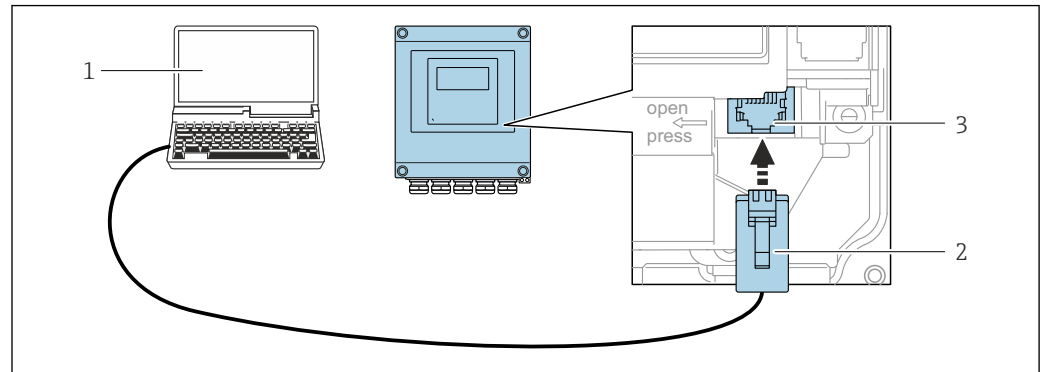

A0029163

32 Connection via service interface (CDI-RJ45)

- 1 Computer with Web browser (e.g. Microsoft Internet Explorer, Microsoft Edge) for accessing the integrated device Web server or with "FieldCare", "DeviceCare" operating tool with COM DTM "CDI Communication TCP/IP"
- 2 Standard Ethernet connecting cable with RJ45 connector
- 3 Service interface (CDI-RJ45) of the measuring device with access to the integrated Web server

Proline 500 transmitter

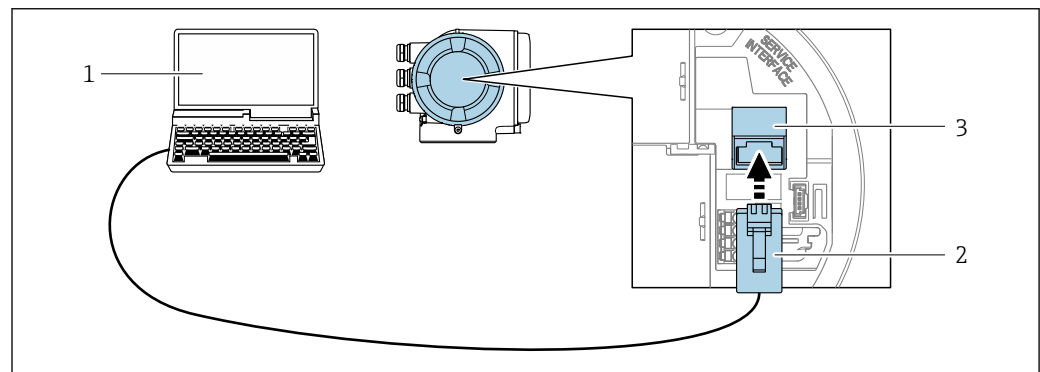

A0027563

33 Connection via service interface (CDI-RJ45)

- 1 Computer with Web browser (e.g. Microsoft Internet Explorer, Microsoft Edge) for accessing the integrated device Web server or with "FieldCare", "DeviceCare" operating tool with COM DTM "CDI Communication TCP/IP"
- 2 Standard Ethernet connecting cable with RJ45 connector
- 3 Service interface (CDI-RJ45) of the measuring device with access to the integrated Web server

Via WLAN interface

The optional WLAN interface is available on the following device version:

Order code for "Display; operation", option **G** "4-line, backlit, graphic display; touch control + WLAN"

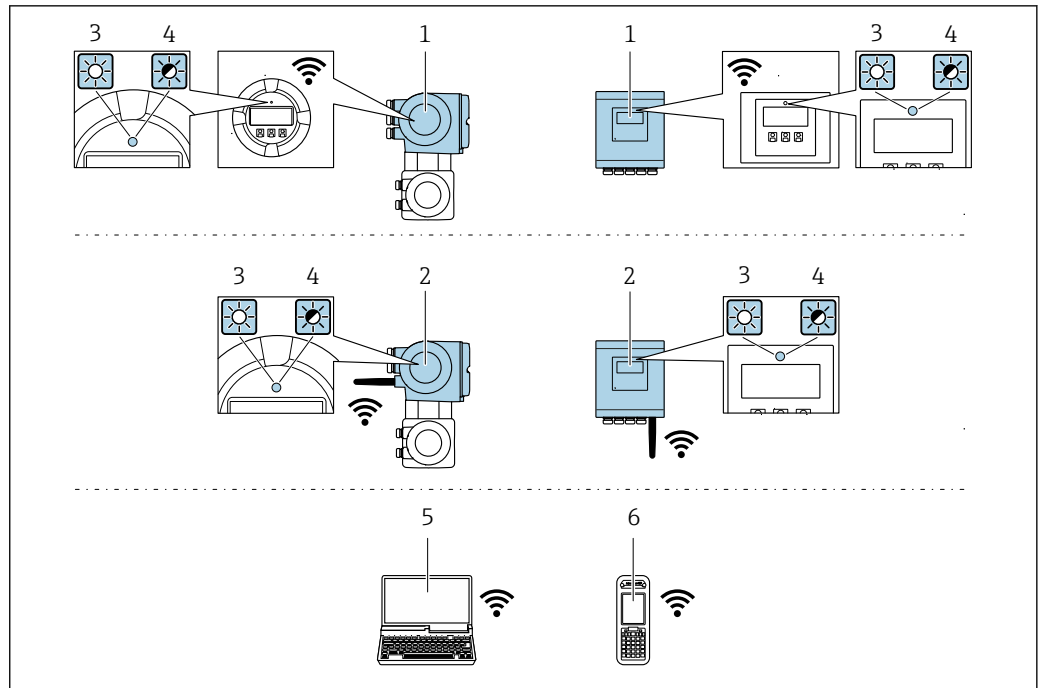

A0029165

- 1 Transmitter with integrated WLAN antenna
- 2 Transmitter with external WLAN antenna
- 3 LED lit constantly: WLAN reception is enabled on measuring device
- 4 LED flashing: WLAN connection established between operating unit and measuring device
- 5 Computer with WLAN interface and Web browser (e.g. Microsoft Internet Explorer, Microsoft Edge) for accessing the integrated device Web server or with operating tool (e.g. FieldCare, DeviceCare)
- 6 Mobile handheld terminal with WLAN interface and Web browser (e.g. Microsoft Internet Explorer, Microsoft Edge) for accessing the integrated device Web server or operating tool (e.g. FieldCare, DeviceCare)

Wireless LAN	IEEE 802.11 b/g (2.4 GHz) WLAN
Encryption	WPA2 PSK/TKIP AES-128
Configurable channels	1 to 11
Function	Access point with DHCP
Range with integrated antenna	Max. 10 m (32 ft)
Range with external antenna	Max. 50 m (164 ft)

Configuring the Internet protocol of the operating unit

NOTICE

If the WLAN connection is lost during the configuration, settings made may be lost.
 ► Make sure that the WLAN connection is not disconnected while configuring the device.

NOTICE

In principle, avoid simultaneous access to the measuring device via the service interface (CDI-RJ45) and the WLAN interface from the same operating unit. This could cause a network conflict.

- Only activate one service interface (CDI-RJ45 service interface or WLAN interface).
- If simultaneous communication is necessary: configure different IP address ranges, e.g. 192.168.0.1 (WLAN interface) and 192.168.1.212 (CDI-RJ45 service interface).

Preparation

- Enable WLAN reception on the operating unit.

Establishing a connection

1. Select the measuring device using the SSID (e.g. EH_Promass_500_A802000).
2. If necessary, select the WPA2 encryption method.
3. Enter the password: serial number of the measuring device ex-works (e.g. L100A802000).
 - ↳ LED on display module flashes: it is now possible to operate the measuring device with the Web browser, FieldCare or DeviceCare.



The serial number can be found on the nameplate.

Disconnecting

- ▶ Once the configuration is completed, disconnect the WLAN connection between the operating unit and the measuring device.

8.5.2 Field Xpert SFX350, SFX370**Function scope**

Field Xpert SFX350 and Field Xpert SFX370 are mobile computers for commissioning and maintenance. They enable efficient device configuration and diagnostics for HART and FOUNDATION fieldbus devices in the **non-Ex area** (SFX350, SFX370) and the **Ex area** (SFX370).



For details, see Operating Instructions BA01202S

Source for device description files

See data → 87

8.5.3 FieldCare**Function scope**

FDT-based plant asset management tool from Endress+Hauser. It can configure all smart field devices in a system and helps you manage them. By using the status information, it is also a simple but effective way of checking their status and condition.

Access is via:

- HART protocol
- CDI-RJ45 service interface → 82
- WLAN interface → 82

Typical functions:

- Configuring parameters of transmitters
- Loading and saving device data (upload/download)
- Documentation of the measuring point
- Visualization of the measured value memory (line recorder) and event logbook



For additional information about FieldCare, see Operating Instructions BA00027S and BA00059S

Source for device description files

See information → 87

Establishing a connection

1. Start FieldCare and launch the project.

2. In the network: Add a device.
↳ The **Add device** window opens.
3. Select the **CDI Communication TCP/IP** option from the list and press **OK** to confirm.
4. Right-click **CDI Communication TCP/IP** and select the **Add device** option in the context menu that opens.
5. Select the desired device from the list and press **OK** to confirm.
↳ The **CDI Communication TCP/IP (Configuration)** window opens.
6. Enter the device address in the **IP address** field: 192.168.1.212 and press **Enter** to confirm.
7. Establish the online connection to the device.

 For additional information, see Operating Instructions BA00027S and BA00059S

User interface

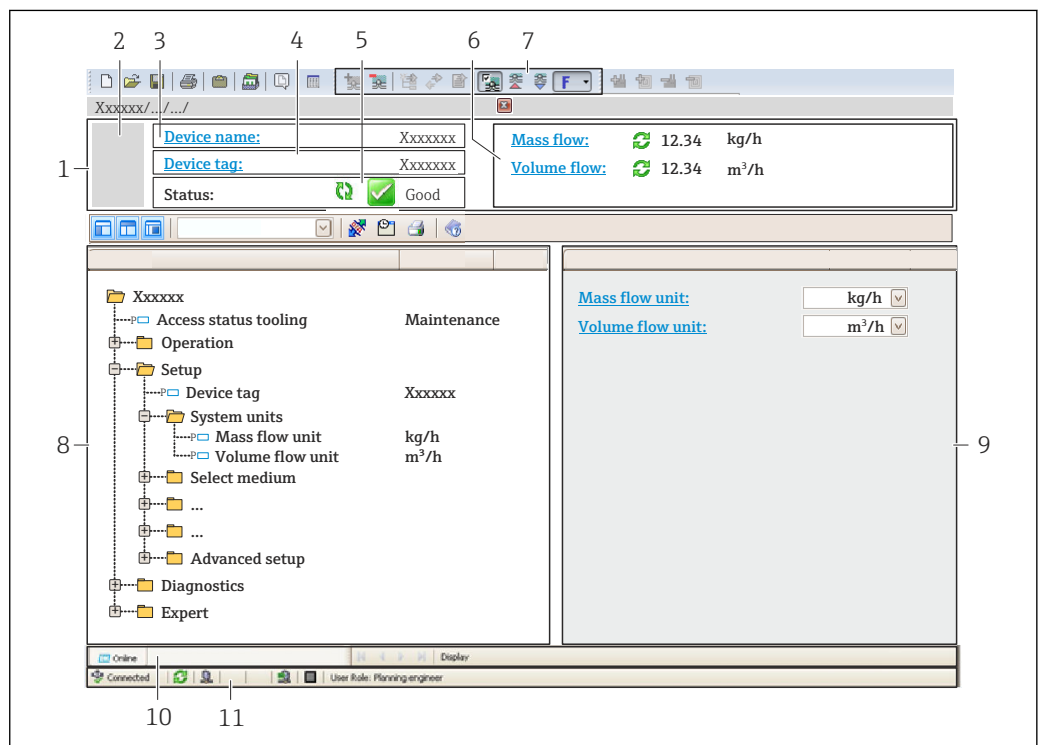

A0021051-EN

- 1 Header
- 2 Picture of device
- 3 Device name
- 4 Tag name
- 5 Status area with status signal →  160
- 6 Display area for current measured values
- 7 Edit toolbar with additional functions such as save/restore, event list and create documentation
- 8 Navigation area with operating menu structure
- 9 Working area
- 10 Range of action
- 11 Status area

8.5.4 DeviceCare

Function scope

Tool to connect and configure Endress+Hauser field devices.

The fastest way to configure Endress+Hauser field devices is with the dedicated "DeviceCare" tool. Together with the device type managers (DTMs) it presents a convenient, comprehensive solution.



For details, see Innovation Brochure IN01047S

Source for device description files

See information →  87

8.5.5 AMS Device Manager

Function scope

Program from Emerson Process Management for operating and configuring measuring devices via HART protocol.

Source for device description files

See data →  87

8.5.6 SIMATIC PDM

Function scope

SIMATIC PDM is a standardized, manufacturer-independent program from Siemens for the operation, configuration, maintenance and diagnosis of intelligent field devices via HART protocol.

Source for device description files

See data →  87

8.5.7 Field Communicator 475

Function scope

Industrial handheld terminal from Emerson Process Management for remote configuration and measured value display via HART protocol.

Source for device description files

See data →  87

9 System integration

9.1 Overview of device description files

9.1.1 Current version data for the device

Firmware version	01.00.zz	<ul style="list-style-type: none"> ▪ On the title page of the Operating instructions ▪ On the transmitter nameplate ▪ Firmware version Diagnostics → Device information → Firmware version
Release date of firmware version	08.2016	---
Manufacturer ID	0x11	Manufacturer ID Diagnostics → Device information → Manufacturer ID
Device type ID	0x3B	Device type Diagnostics → Device information → Device type
HART protocol revision	7	---
Device revision	1	<ul style="list-style-type: none"> ▪ On the transmitter nameplate ▪ Device revision Diagnostics → Device information → Device revision

 For an overview of the different firmware versions for the device →  173

9.1.2 Operating tools

The suitable device description file for the individual operating tools is listed in the table below, along with information on where the file can be acquired.

Operating tool via HART protocol	Sources for obtaining device descriptions
FieldCare	<ul style="list-style-type: none"> ▪ www.endress.com → Download Area ▪ CD-ROM (contact Endress+Hauser) ▪ DVD (contact Endress+Hauser)
DeviceCare	<ul style="list-style-type: none"> ▪ www.endress.com → Download Area ▪ CD-ROM (contact Endress+Hauser) ▪ DVD (contact Endress+Hauser)
<ul style="list-style-type: none"> ▪ Field Xpert SFX350 ▪ Field Xpert SFX370 	Use update function of handheld terminal
AMS Device Manager (Emerson Process Management)	www.endress.com → Download Area
SIMATIC PDM (Siemens)	www.endress.com → Download Area
Field Communicator 475 (Emerson Process Management)	Use update function of handheld terminal

9.2 Measured variables via HART protocol

The following measured variables (HART device variables) are assigned to the dynamic variables at the factory:

Dynamic variables	Measured variables (HART device variables)
Primary dynamic variable (PV)	Mass flow
Secondary dynamic variable (SV)	Totalizer 1
Tertiary dynamic variable (TV)	Density
Quaternary dynamic variable (QV)	Temperature

The assignment of the measured variables to the dynamic variables can be modified and assigned as desired via local operation and the operating tool using the following parameters:

- Expert → Communication → HART output → Output → Assign PV
- Expert → Communication → HART output → Output → Assign SV
- Expert → Communication → HART output → Output → Assign TV
- Expert → Communication → HART output → Output → Assign QV

The following measured variables can be assigned to the dynamic variables:

Measured variables for PV (primary dynamic variable)

- Off
- Mass flow
- Volume flow
- Corrected volume flow
- Density
- Reference density
- Temperature
- Electronic temperature
- Oscillation frequency 0
- Frequency fluctuation 0
- Oscillation damping 0
- Oscillation damping fluctuation 0
- Signal asymmetry
- Exciter current 0

Measured variables for SV, TV, QV (secondary, tertiary and quaternary dynamic variable)

- Mass flow
- Volume flow
- Corrected volume flow
- Density
- Reference density
- Temperature
- Electronic temperature
- Totalizer 1...3



The range of options increases if the measuring device has one or more application packages.

Heartbeat Technology Application Package

Additional measured variables are available with the Heartbeat Technology application package:

Carrier pipe temperature

Device variables

The device variables are permanently assigned. A maximum of 8 device variables can be transmitted:

- 0 = mass flow
- 1 = volume flow
- 2 = corrected volume flow
- 3 = density
- 4 = reference density

- 5 = temperature
- 6 = totalizer 1
- 7 = totalizer 2
- 8 = totalizer 3
- 13 = target mass flow
- 14 = carrier mass flow
- 15 = concentration

9.3 Other settings

9.3.1 Burst mode functionality in accordance with HART 7 Specification

Navigation

"Expert" menu → Communication → HART output → Burst configuration → Burst configuration 1 to n

▶ Burst configuration

▶ Burst configuration 1 to n

Burst mode 1 to n	→ ⓘ 90
Burst command 1 to n	→ ⓘ 90
Burst variable 0	→ ⓘ 90
Burst variable 1	→ ⓘ 90
Burst variable 2	→ ⓘ 90
Burst variable 3	→ ⓘ 90
Burst variable 4	→ ⓘ 90
Burst variable 5	→ ⓘ 90
Burst variable 6	→ ⓘ 90
Burst variable 7	→ ⓘ 90
Burst trigger mode	→ ⓘ 90
Burst trigger level	→ ⓘ 90
Min. update period	→ ⓘ 91
Max. update period	→ ⓘ 91

Parameter overview with brief description

Parameter	Description	Selection / User entry	Factory setting
Burst mode 1 to n	Activate the HART burst mode for burst message X.	<ul style="list-style-type: none"> ■ Off ■ On 	Off
Burst command 1 to n	Select the HART command that is sent to the HART master.	<ul style="list-style-type: none"> ■ Command 1 ■ Command 2 ■ Command 3 ■ Command 9 ■ Command 33 ■ Command 48 	Command 2
Burst variable 0	For HART command 9 and 33, assign a HART device variable or process variable to burst variable.	<ul style="list-style-type: none"> ■ Mass flow ■ Volume flow ■ Corrected volume flow ■ Target mass flow[*] ■ Carrier mass flow[*] ■ Density ■ Reference density ■ Concentration[*] ■ Temperature ■ Totalizer 1 ■ Totalizer 2 ■ Totalizer 3 ■ HART input ■ Percent of range ■ Measured current ■ Primary variable (PV) ■ Secondary variable (SV) ■ Tertiary variable (TV) ■ Quaternary variable (QV) ■ Not used 	Volume flow
Burst variable 1	For HART command 9 and 33, assign a HART device variable or process variable to burst variable.	See the Burst variable 0 parameter.	Not used
Burst variable 2	For HART command 9 and 33, assign a HART device variable or process variable to burst variable.	See the Burst variable 0 parameter.	Not used
Burst variable 3	For HART command 9 and 33, assign a HART device variable or process variable to burst variable.	See the Burst variable 0 parameter.	Not used
Burst variable 4	For HART command 33, assign a HART device variable or process variable to burst variable.	See the Burst variable 0 parameter.	Not used
Burst variable 5	For HART command 33, assign a HART device variable or process variable to burst variable.	See the Burst variable 0 parameter.	Not used
Burst variable 6	For HART command 33, assign a HART device variable or process variable to burst variable.	See the Burst variable 0 parameter.	Not used
Burst variable 7	For HART command 33, assign a HART device variable or process variable to burst variable.	See the Burst variable 0 parameter.	Not used
Burst trigger mode	Select the event that triggers burst message X.	<ul style="list-style-type: none"> ■ Continuous ■ Window ■ Rising ■ Falling ■ On change 	Continuous
Burst trigger level	Enter the burst trigger value. Together with the option selected in the Burst trigger mode parameter the burst trigger value determines the time of burst message X.	Positive floating-point number	–

Parameter	Description	Selection / User entry	Factory setting
Min. update period	Enter the minimum time span between two burst responses of one burst message.	Positive integer	1 000 ms
Max. update period	Enter the maximum time span between two burst responses of one burst message.	Positive integer	2 000 ms

* Visibility depends on order options or device settings

10 Commissioning

10.1 Function check

Before commissioning the measuring device:

- ▶ Make sure that the post-installation and post-connection checks have been performed.
 - "Post-installation check" checklist → 35
 - "Post-connection check" checklist → 59

10.2 Switching on the measuring device

- ▶ After a successful function check, switch on the measuring device.
 - ↳ After a successful startup, the local display switches automatically from the startup display to the operational display.

If nothing appears on the local display or a diagnostic message is displayed, refer to the section on "Diagnostics and troubleshooting" → 151.

10.3 Setting the operating language

Factory setting: English or ordered local language

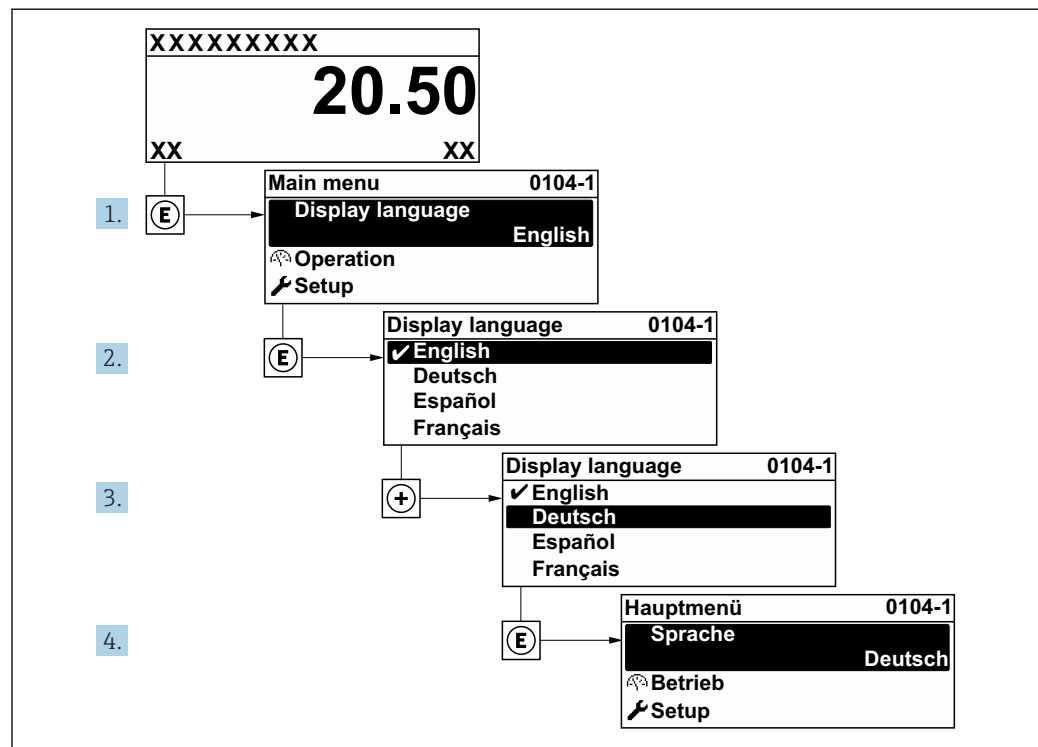

34 Taking the example of the local display

A0029420

10.4 Configuring the measuring device

- The **Setup** menu with its guided wizards contains all the parameters needed for standard operation.
- Navigation to the **Setup** menu

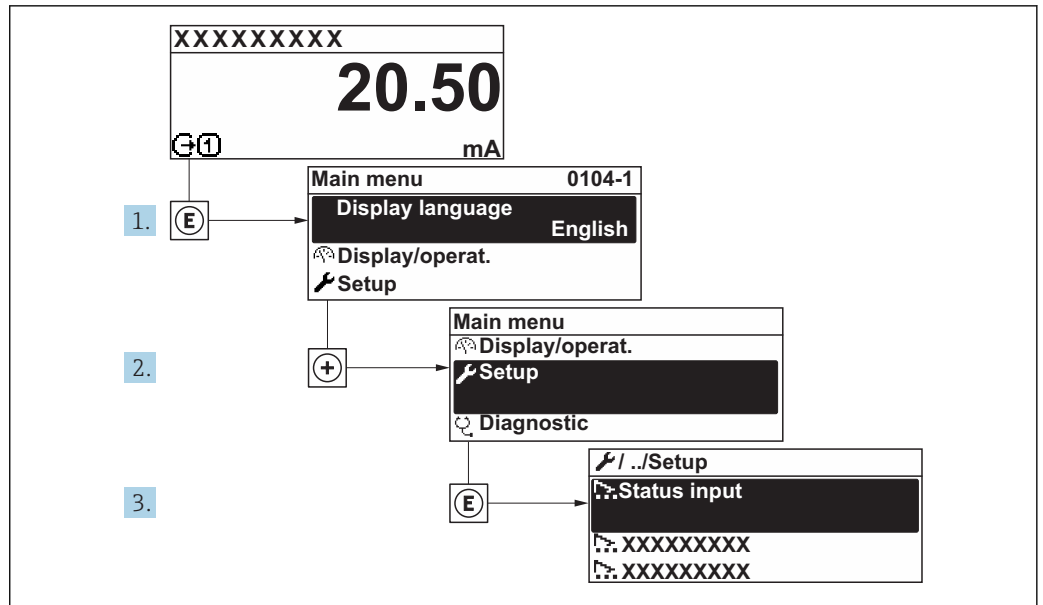

A0029700-EN

35 Taking the example of the local display

i Depending on the device version, not all submenus and parameters are available in every device. The selection can vary depending on the order code.

Setup	
Device tag	
▶ System units	→ 94
▶ Medium selection	→ 97
▶ Analog inputs	
▶ I/O configuration	→ 98
▶ Current input 1 to n	→ 99
▶ Status input 1 to n	→ 100
▶ Current output 1 to n	→ 101
▶ Pulse/frequency/switch output 1 to n	→ 104
▶ Relay output 1 to n	→ 113
▶ Display	→ 116
▶ Low flow cut off	→ 119

▶ Partially filled pipe detection	→ 120
▶ Advanced setup	→ 121

10.4.1 Defining the tag name

To enable fast identification of the measuring point within the system, you can enter a unique designation using the **Device tag** parameter and thus change the factory setting.

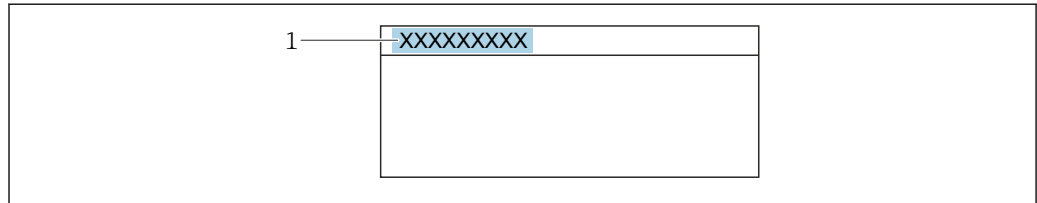

36 Header of the operational display with tag name

1 Tag name

i Enter the tag name in the "FieldCare" operating tool → 85

Navigation

"Setup" menu → Device tag

Parameter overview with brief description

Parameter	Description	User entry	Factory setting
Device tag	Enter the name for the measuring point.	Max. 32 characters, such as letters, numbers or special characters (e.g. @, %, /).	Promass

10.4.2 Setting the system units

In the **System units** submenu the units of all the measured values can be set.

i Depending on the device version, not all submenus and parameters are available in every device. The selection can vary depending on the order code.

Navigation

"Setup" menu → System units

▶ System units	
Mass flow unit	→ 95
Mass unit	→ 95
Volume flow unit	→ 95
Volume unit	→ 95

Corrected volume flow unit	→ ⓘ 95
Corrected volume unit	→ ⓘ 95
Density unit	→ ⓘ 95
Reference density unit	→ ⓘ 95
Temperature unit	→ ⓘ 96
Pressure unit	→ ⓘ 96

Parameter overview with brief description

Parameter	Description	Selection	Factory setting
Mass flow unit	Select mass flow unit. <i>Result</i> The selected unit applies for: <ul style="list-style-type: none"> ▪ Output ▪ Low flow cut off ▪ Simulation process variable 	Unit choose list	Country-specific: <ul style="list-style-type: none"> ▪ kg/h ▪ lb/min
Mass unit	Select mass unit.	Unit choose list	Country-specific: <ul style="list-style-type: none"> ▪ kg ▪ lb
Volume flow unit	Select volume flow unit. <i>Result</i> The selected unit applies for: <ul style="list-style-type: none"> ▪ Output ▪ Low flow cut off ▪ Simulation process variable 	Unit choose list	Country-specific: <ul style="list-style-type: none"> ▪ l/h ▪ gal/min (us)
Volume unit	Select volume unit.	Unit choose list	Country-specific: <ul style="list-style-type: none"> ▪ l (DN > 150 (6"): m³) ▪ gal (us)
Corrected volume flow unit	Select corrected volume flow unit. <i>Result</i> The selected unit applies for: Corrected volume flow parameter (→ ⓘ 142)	Unit choose list	Country-specific: <ul style="list-style-type: none"> ▪ NI/h ▪ Sft³/min
Corrected volume unit	Select corrected volume unit.	Unit choose list	Country-specific: <ul style="list-style-type: none"> ▪ NI ▪ Sft³
Density unit	Select density unit. <i>Result</i> The selected unit applies for: <ul style="list-style-type: none"> ▪ Output ▪ Simulation process variable ▪ Density adjustment (Expert menu) 	Unit choose list	Country-specific: <ul style="list-style-type: none"> ▪ kg/l ▪ lb/ft³
Reference density unit	Select reference density unit.	Unit choose list	Country-dependent <ul style="list-style-type: none"> ▪ kg/NI ▪ lb/Sft³

Parameter	Description	Selection	Factory setting
Temperature unit	<p>Select temperature unit.</p> <p><i>Result</i></p> <p>The selected unit applies for:</p> <ul style="list-style-type: none"> ▪ Electronic temperature parameter (6053) ▪ Maximum value parameter (6051) ▪ Minimum value parameter (6052) ▪ External temperature parameter (6080) ▪ Maximum value parameter (6108) ▪ Minimum value parameter (6109) ▪ Carrier pipe temperature parameter (6027) ▪ Maximum value parameter (6029) ▪ Minimum value parameter (6030) ▪ Reference temperature parameter (1816) ▪ Temperature parameter 	Unit choose list	<p>Country-specific:</p> <ul style="list-style-type: none"> ▪ °C ▪ °F
Pressure unit	<p>Select process pressure unit.</p> <p><i>Result</i></p> <p>The unit is taken from:</p> <ul style="list-style-type: none"> ▪ Pressure value parameter (→ ⓘ 98) ▪ External pressure parameter (→ ⓘ 98) ▪ Pressure value 	Unit choose list	<p>Country-specific:</p> <ul style="list-style-type: none"> ▪ bar a ▪ psi a

10.4.3 Selecting and setting the medium

The **Select medium** wizard submenu contains parameters that must be configured in order to select and set the medium.

Navigation

"Setup" menu → Select medium

► Medium selection	
Select medium	→ 98
Select gas type	→ 98
Reference sound velocity	→ 98
Temperature coefficient sound velocity	→ 98
Pressure compensation	→ 98
Pressure value	→ 98
External pressure	→ 98

Parameter overview with brief description

Parameter	Prerequisite	Description	Selection / User entry / User interface	Factory setting
Select medium	–	Select medium type.	<ul style="list-style-type: none"> ▪ Liquid ▪ Gas 	Liquid
Select gas type	The Gas option is selected in the Select medium parameter.	Select measured gas type.	<ul style="list-style-type: none"> ▪ Air ▪ Ammonia NH₃ ▪ Argon Ar ▪ Sulfur hexafluoride SF₆ ▪ Oxygen O₂ ▪ Ozone O₃ ▪ Nitrogen oxide NO_x ▪ Nitrogen N₂ ▪ Nitrous oxide N₂O ▪ Methane CH₄ ▪ Hydrogen H₂ ▪ Helium He ▪ Hydrogen chloride HCl ▪ Hydrogen sulfide H₂S ▪ Ethylene C₂H₄ ▪ Carbon dioxide CO₂ ▪ Carbon monoxide CO ▪ Chlorine Cl₂ ▪ Butane C₄H₁₀ ▪ Propane C₃H₈ ▪ Propylene C₃H₆ ▪ Ethane C₂H₆ ▪ Others 	Methane CH ₄
Reference sound velocity	In the Select gas type parameter, the Others option is selected.	Enter sound velocity of gas at 0 °C (32 °F).	1 to 99 999.9999 m/s	415.0 m/s
Temperature coefficient sound velocity	The Others option is selected in the Select gas type parameter.	Enter temperature coefficient for the gas sound velocity.	Positive floating-point number	0 (m/s)/K
Pressure compensation	–	Select pressure compensation type.	<ul style="list-style-type: none"> ▪ Off ▪ Fixed value ▪ External value ▪ Current input 1 * ▪ Current input 2 * ▪ Current input 3 * 	Off
Pressure value	The Fixed value option is selected in the Pressure compensation parameter.	Enter process pressure to be used for pressure correction.	Positive floating-point number	0 bar
External pressure	The External value option is selected in the Pressure compensation parameter.	Shows the external process pressure value.	Positive floating-point number	0 bar

* Visibility depends on order options or device settings

10.4.4 Displaying the I/O configuration

The **I/O configuration** submenu guides the user systematically through all the parameters in which the configuration of the I/O modules is displayed.

Navigation
 "Setup" menu → I/O configuration

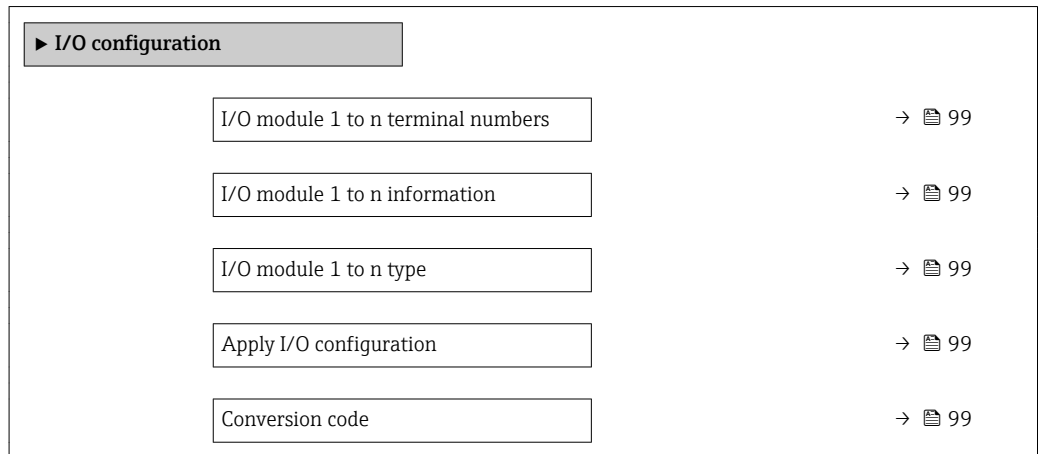

Parameter overview with brief description

Parameter	Description	User interface / Selection / User entry	Factory setting
I/O module 1 to n terminal numbers	Shows the terminal numbers used by the I/O module.	<ul style="list-style-type: none"> Not used 26-27 (I/O 1) 24-25 (I/O 2) 22-23 (I/O 3) 20-21 (I/O 4) * 	–
I/O module 1 to n information	Shows information of the plugged I/O module.	<ul style="list-style-type: none"> Not plugged Invalid Not configurable Configurable Fieldbus 	–
I/O module 1 to n type	Shows the I/O module type.	<ul style="list-style-type: none"> Off Current output * Current input * Status input * Pulse/frequency/switch output * 	Off
Apply I/O configuration	Apply parameterization of the freely configurable I/O module.	<ul style="list-style-type: none"> No Yes 	No
Conversion code	Enter the code in order to change the I/O configuration.	Positive integer	0





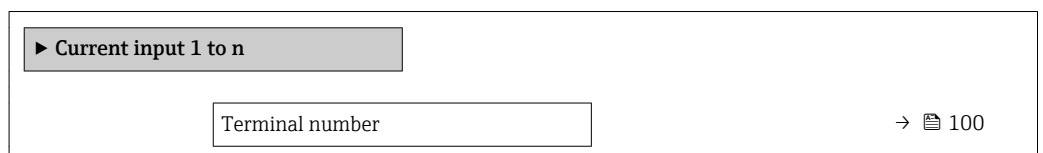

* Visibility depends on order options or device settings

10.4.5 Configuring the current input

The "Current input" wizard guides the user systematically through all the parameters that have to be set for configuring the current input.

Navigation
 "Setup" menu → Current input



Signal mode	→  100
0/4 mA value	→  100
20 mA value	→  100
Current span	→  100
Failure mode	→  100
Failure value	→  100

Parameter overview with brief description

Parameter	Prerequisite	Description	User interface / Selection / User entry	Factory setting
Terminal number	–	Shows the terminal numbers used by the current input module.	<ul style="list-style-type: none"> ▪ Not used ▪ 24-25 (I/O 2) ▪ 22-23 (I/O 3) ▪ 20-21 (I/O 4) * 	–
Signal mode	The measuring device is not approved for use in the hazardous area with type of protection Ex-i.	Select the signal mode for the current input.	<ul style="list-style-type: none"> ▪ Passive ▪ Active 	Passive
0/4 mA value	–	Enter 4 mA value.	Signed floating-point number	0
20 mA value	–	Enter 20 mA value.	Signed floating-point number	Depends on country and nominal diameter
Current span	–	Select current range for process value output and upper/lower level for alarm signal.	<ul style="list-style-type: none"> ▪ 4...20 mA ▪ 4...20 mA NAMUR ▪ 4...20 mA US ▪ 0...20 mA 	Country-specific: <ul style="list-style-type: none"> ▪ 4...20 mA NAMUR ▪ 4...20 mA US
Failure mode	–	Define input behavior in alarm condition.	<ul style="list-style-type: none"> ▪ Alarm ▪ Last valid value ▪ Defined value 	Alarm
Failure value	In the Failure mode parameter, the Defined value option is selected.	Enter value to be used by the device if input value from external device is missing.	Signed floating-point number	0

* Visibility depends on order options or device settings

10.4.6 Configuring the status input

The **Status input** submenu guides the user systematically through all the parameters that have to be set for configuring the status input.

Navigation

"Setup" menu → Status input

▶ **Status input 1 to n**

Assign status input	→ ⓘ 101
Terminal number	→ ⓘ 101
Active level	→ ⓘ 101
Terminal number	→ ⓘ 101
Response time status input	→ ⓘ 101
Terminal number	→ ⓘ 101

Parameter overview with brief description

Parameter	Description	User interface / Selection / User entry	Factory setting
Terminal number	Shows the terminal numbers used by the status input module.	<ul style="list-style-type: none"> ▪ Not used ▪ 24-25 (I/O 2) ▪ 22-23 (I/O 3) ▪ 20-21 (I/O 4) * 	-
Assign status input	Select function for the status input.	<ul style="list-style-type: none"> ▪ Off ▪ Reset totalizer 1 ▪ Reset totalizer 2 ▪ Reset totalizer 3 ▪ Reset all totalizers ▪ Flow override 	Off
Active level	Define input signal level at which the assigned function is triggered.	<ul style="list-style-type: none"> ▪ High ▪ Low 	High
Response time status input	Define the minimum amount of time the input signal level must be present before the selected function is triggered.	5 to 200 ms	50 ms

* Visibility depends on order options or device settings

10.4.7 Configuring the current output







The **Current output** wizard guides you systematically through all the parameters that have to be set for configuring the current output.

Navigation

"Setup" menu → Current output





▶ **Current output 1 to n**

Terminal number	→ ⓘ 102
Signal mode	→ ⓘ 102

Assign current output 1 to n	→  102
Current span	→  102
0/4 mA value	→  103
20 mA value	→  103
Fixed current	→  103
Failure mode	→  103
Failure current	→  103

Parameter overview with brief description

Parameter	Prerequisite	Description	Selection / User interface / User entry	Factory setting
Assign current output 1 to n	–	Select process variable for current output.	<ul style="list-style-type: none"> ▪ Off ▪ Mass flow ▪ Volume flow ▪ Corrected volume flow ▪ Target mass flow * ▪ Carrier mass flow * ▪ Density ▪ Reference density ▪ Concentration * ▪ Temperature ▪ Carrier pipe temperature * ▪ Electronic temperature ▪ Oscillation frequency 0 ▪ Oscillation amplitude 0 * ▪ Frequency fluctuation 0 ▪ Oscillation damping 0 ▪ Oscillation damping fluctuation 0 ▪ Signal asymmetry ▪ Exciter current 0 	Mass flow
Terminal number	–	Shows the terminal numbers used by the current output module.	<ul style="list-style-type: none"> ▪ Not used ▪ 26-27 (I/O 1) ▪ 24-25 (I/O 2) ▪ 22-23 (I/O 3) * ▪ 20-21 (I/O 4) * 	–
Current span	–	Select current range for process value output and upper/lower level for alarm signal.	<ul style="list-style-type: none"> ▪ 4...20 mA NAMUR ▪ 4...20 mA US ▪ 4...20 mA ▪ 0...20 mA ▪ Fixed current 	Country-specific: <ul style="list-style-type: none"> ▪ 4...20 mA NAMUR ▪ 4...20 mA US
Signal mode	–	Select the signal mode for the current output.	<ul style="list-style-type: none"> ▪ Passive ▪ Active 	Passive

Parameter	Prerequisite	Description	Selection / User interface / User entry	Factory setting
0/4 mA value	One of the following options is selected in the Current span parameter (→  102): <ul style="list-style-type: none"> ▪ 4...20 mA NAMUR ▪ 4...20 mA US ▪ 4...20 mA ▪ 0...20 mA 	Enter 4 mA value.	Signed floating-point number	Country-specific: <ul style="list-style-type: none"> ▪ 0 kg/h ▪ 0 lb/min
20 mA value	One of the following options is selected in the Current span parameter (→  102): <ul style="list-style-type: none"> ▪ 4...20 mA NAMUR ▪ 4...20 mA US ▪ 4...20 mA ▪ 0...20 mA 	Enter 20 mA value.	Signed floating-point number	Depends on country and nominal diameter
Fixed current	In the Current span parameter (→  102), the Fixed current option is selected.	Defines the fixed output current.	0 to 22.5 mA	22.5 mA
Failure mode	One of the following options is selected in the Assign current output parameter (→  102): <ul style="list-style-type: none"> ▪ Mass flow ▪ Volume flow ▪ Corrected volume flow ▪ Target mass flow * ▪ Carrier mass flow * ▪ Density ▪ Reference density ▪ Concentration * ▪ Temperature ▪ Carrier pipe temperature * ▪ Electronic temperature ▪ Oscillation frequency 0 ▪ Oscillation amplitude 0 * ▪ Frequency fluctuation 0 ▪ Oscillation damping 0 ▪ Oscillation damping fluctuation 0 ▪ Signal asymmetry ▪ Exciter current 0 One of the following options is selected in the Current span parameter (→  102): <ul style="list-style-type: none"> ▪ 4...20 mA NAMUR ▪ 4...20 mA US ▪ 4...20 mA ▪ 0...20 mA 	Define output behavior in alarm condition.	<ul style="list-style-type: none"> ▪ Min. ▪ Max. ▪ Last valid value ▪ Actual value ▪ Defined value 	Max.
Failure current	In the Failure mode parameter, the Defined value option is selected.	Enter current output value in alarm condition.	0 to 22.5 mA	22.5 mA

* Visibility depends on order options or device settings

10.4.8 Configuring the pulse/frequency/switch output

The **Pulse/frequency/switch output** wizard guides you systematically through all the parameters that can be set for configuring the selected output type.

Navigation

"Setup" menu → Advanced setup → Pulse/frequency/switch output

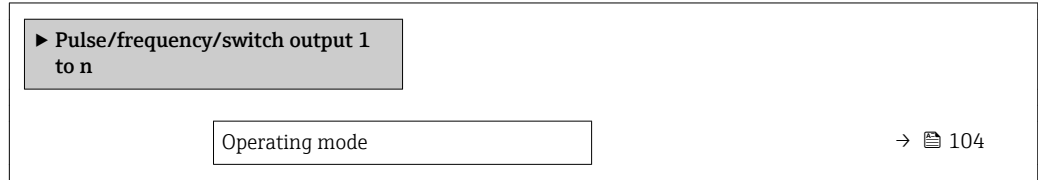

Parameter overview with brief description

Parameter	Description	Selection	Factory setting
Operating mode	Define the output as a pulse, frequency or switch output.	<ul style="list-style-type: none"> ■ Pulse ■ Frequency ■ Switch 	Pulse



Configuring the pulse output

Navigation

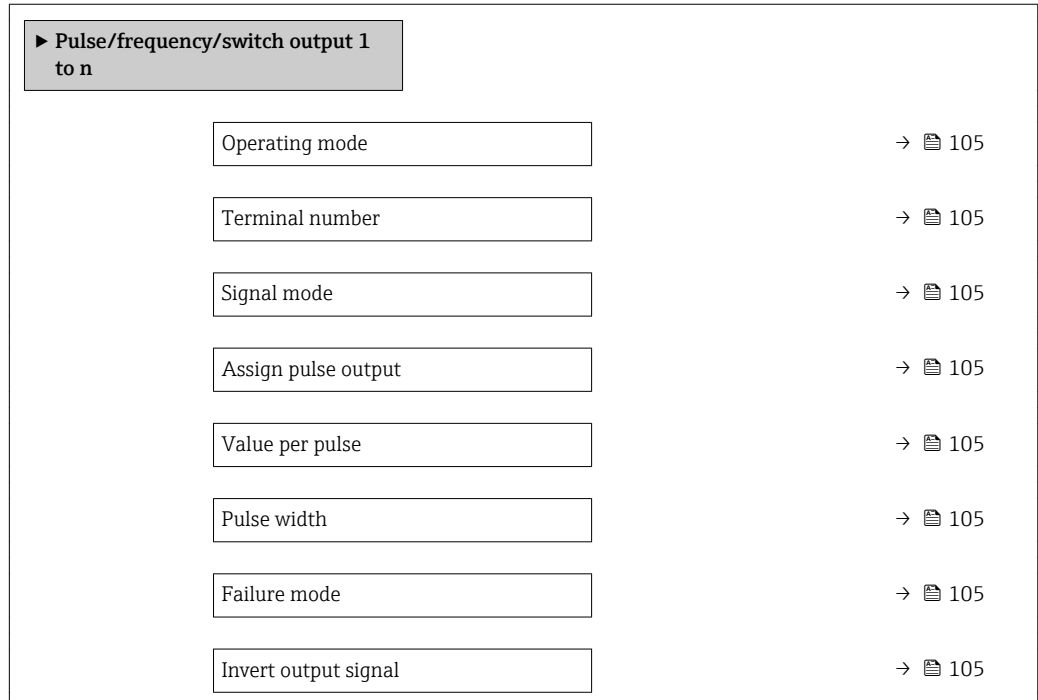
"Setup" menu → Pulse/frequency/switch output



Parameter overview with brief description

Parameter	Prerequisite	Description	Selection / User interface / User entry	Factory setting
Operating mode	–	Define the output as a pulse, frequency or switch output.	<ul style="list-style-type: none"> ■ Pulse ■ Frequency ■ Switch 	Pulse
Terminal number	–	Shows the terminal numbers used by the PFS output module.	<ul style="list-style-type: none"> ■ Not used ■ 24-25 (I/O 2) ■ 22-23 (I/O 3) ■ 20-21 (I/O 4)* 	–
Signal mode	–	Select the signal mode for the PFS output.	<ul style="list-style-type: none"> ■ Passive ■ Active 	Passive
Assign pulse output 1 to n	In the Operating mode parameter, the Pulse option is selected.	Select process variable for pulse output.	<ul style="list-style-type: none"> ■ Off ■ Mass flow ■ Volume flow ■ Corrected volume flow ■ Target mass flow* ■ Carrier mass flow* 	Off
Value per pulse	In the Operating mode parameter, the Pulse option is selected and one of the following options is selected in the Assign pulse output parameter (→  105): <ul style="list-style-type: none"> ■ Mass flow ■ Volume flow ■ Corrected volume flow ■ Target mass flow* ■ Carrier mass flow* 	Enter measured value at which a pulse is output.	Signed floating-point number	Depends on country and nominal diameter
Pulse width	In the Operating mode parameter, the Pulse option is selected and one of the following options is selected in the Assign pulse output parameter (→  105): <ul style="list-style-type: none"> ■ Mass flow ■ Volume flow ■ Corrected volume flow ■ Target mass flow* ■ Carrier mass flow* 	Define time width of the output pulse.	0.05 to 2 000 ms	100 ms
Failure mode	In the Operating mode parameter, the Pulse option is selected and one of the following options is selected in the Assign pulse output parameter (→  105): <ul style="list-style-type: none"> ■ Mass flow ■ Volume flow ■ Corrected volume flow ■ Target mass flow* ■ Carrier mass flow* 	Define output behavior in alarm condition.	<ul style="list-style-type: none"> ■ Actual value ■ No pulses 	No pulses
Invert output signal	–	Invert the output signal.	<ul style="list-style-type: none"> ■ No ■ Yes 	No

* Visibility depends on order options or device settings

Configuring the frequency output

Navigation



"Setup" menu → Pulse/frequency/switch output



► Pulse/frequency/switch output 1 to n	
Operating mode	→ 106
Terminal number	→ 106
Signal mode	→ 106
Assign frequency output	→ 107
Minimum frequency value	→ 107
Maximum frequency value	→ 108
Measuring value at minimum frequency	→ 108
Measuring value at maximum frequency	→ 109
Failure mode	→ 109
Failure frequency	→ 110
Invert output signal	→ 110

Parameter overview with brief description

Parameter	Prerequisite	Description	Selection / User interface / User entry	Factory setting
Operating mode	–	Define the output as a pulse, frequency or switch output.	<ul style="list-style-type: none"> ▪ Pulse ▪ Frequency ▪ Switch 	Pulse
Terminal number	–	Shows the terminal numbers used by the PFS output module.	<ul style="list-style-type: none"> ▪ Not used ▪ 24-25 (I/O 2) ▪ 22-23 (I/O 3) ▪ 20-21 (I/O 4) * 	–
Signal mode	–	Select the signal mode for the PFS output.	<ul style="list-style-type: none"> ▪ Passive ▪ Active 	Passive

Parameter	Prerequisite	Description	Selection / User interface / User entry	Factory setting
Assign frequency output	In the Operating mode parameter (→ 104), the Frequency option is selected.	Select process variable for frequency output.	<ul style="list-style-type: none"> ▪ Off ▪ Mass flow ▪ Volume flow ▪ Corrected volume flow ▪ Target mass flow * ▪ Carrier mass flow * ▪ Density ▪ Reference density ▪ Concentration * ▪ Temperature ▪ Carrier pipe temperature * ▪ Electronic temperature ▪ Oscillation frequency 0 ▪ Oscillation amplitude 0 * ▪ Frequency fluctuation 0 ▪ Oscillation damping 0 ▪ Oscillation damping fluctuation 0 ▪ Signal asymmetry ▪ Exciter current 0 ▪ HBSI 	Off
Minimum frequency value	In the Operating mode parameter, the Frequency option is selected and one of the following options is selected in the Assign frequency output parameter (→ 107): <ul style="list-style-type: none"> ▪ Mass flow ▪ Volume flow ▪ Corrected volume flow ▪ Target mass flow * ▪ Carrier mass flow * ▪ Density ▪ Reference density ▪ Concentration * ▪ Temperature ▪ Carrier pipe temperature * ▪ Electronic temperature ▪ Oscillation frequency 0 ▪ Frequency fluctuation 0 * ▪ Oscillation amplitude 0 * ▪ Oscillation damping 0 ▪ Oscillation damping fluctuation 0 ▪ Signal asymmetry ▪ Exciter current 0 	Enter minimum frequency.	0.0 to 10000.0 Hz	0.0 Hz

Parameter	Prerequisite	Description	Selection / User interface / User entry	Factory setting
Maximum frequency value	In the Operating mode parameter, the Frequency option is selected and one of the following options is selected in the Assign frequency output parameter (→  107): <ul style="list-style-type: none"> ▪ Mass flow ▪ Volume flow ▪ Corrected volume flow ▪ Target mass flow * ▪ Carrier mass flow * ▪ Density ▪ Reference density ▪ Concentration * ▪ Temperature ▪ Carrier pipe temperature * ▪ Electronic temperature ▪ Oscillation frequency 0 ▪ Frequency fluctuation 0 ▪ Oscillation amplitude 0 * ▪ Oscillation damping 0 ▪ Oscillation damping fluctuation 0 ▪ Signal asymmetry ▪ Exciter current 0 	Enter maximum frequency.	0.0 to 10 000.0 Hz	10 000.0 Hz
Measuring value at minimum frequency	In the Operating mode parameter, the Frequency option is selected and one of the following options is selected in the Assign frequency output parameter (→  107): <ul style="list-style-type: none"> ▪ Mass flow ▪ Volume flow ▪ Corrected volume flow ▪ Target mass flow * ▪ Carrier mass flow * ▪ Density ▪ Reference density ▪ Concentration * ▪ Temperature ▪ Carrier pipe temperature * ▪ Electronic temperature ▪ Oscillation frequency 0 ▪ Frequency fluctuation 0 ▪ Oscillation amplitude 0 * ▪ Oscillation damping 0 ▪ Oscillation damping fluctuation 0 ▪ Signal asymmetry ▪ Exciter current 0 	Enter measured value for minimum frequency.	Signed floating-point number	Depends on country and nominal diameter

Parameter	Prerequisite	Description	Selection / User interface / User entry	Factory setting
Measuring value at maximum frequency	In the Operating mode parameter, the Frequency option is selected and one of the following options is selected in the Assign frequency output parameter (→  107): <ul style="list-style-type: none"> ▪ Mass flow ▪ Volume flow ▪ Corrected volume flow ▪ Target mass flow[*] ▪ Carrier mass flow[*] ▪ Density ▪ Reference density ▪ Concentration[*] ▪ Temperature ▪ Carrier pipe temperature[*] ▪ Electronic temperature ▪ Oscillation frequency 0 ▪ Frequency fluctuation 0 ▪ Oscillation amplitude 0[*] ▪ Oscillation damping 0 ▪ Oscillation damping fluctuation 0 ▪ Signal asymmetry ▪ Exciter current 0 	Enter measured value for maximum frequency.	Signed floating-point number	Depends on country and nominal diameter
Failure mode	In the Operating mode parameter, the Frequency option is selected and one of the following options is selected in the Assign frequency output parameter (→  107): <ul style="list-style-type: none"> ▪ Mass flow ▪ Volume flow ▪ Corrected volume flow ▪ Target mass flow[*] ▪ Carrier mass flow[*] ▪ Density ▪ Reference density ▪ Concentration[*] ▪ Temperature ▪ Carrier pipe temperature[*] ▪ Electronic temperature ▪ Oscillation frequency 0 ▪ Frequency fluctuation 0 ▪ Oscillation amplitude 0[*] ▪ Oscillation damping 0 ▪ Oscillation damping fluctuation 0 ▪ Signal asymmetry ▪ Exciter current 0 	Define output behavior in alarm condition.	<ul style="list-style-type: none"> ▪ Actual value ▪ Defined value ▪ 0 Hz 	0 Hz

Parameter	Prerequisite	Description	Selection / User interface / User entry	Factory setting
Failure frequency	In the Operating mode parameter, the Frequency option is selected and one of the following options is selected in the Assign frequency output parameter (→  107): <ul style="list-style-type: none"> ▪ Mass flow ▪ Volume flow ▪ Corrected volume flow ▪ Target mass flow * ▪ Carrier mass flow * ▪ Density ▪ Reference density ▪ Concentration * ▪ Temperature ▪ Carrier pipe temperature * ▪ Electronic temperature ▪ Oscillation frequency 0 ▪ Frequency fluctuation 0 ▪ Oscillation amplitude 0 * ▪ Oscillation damping 0 ▪ Oscillation damping fluctuation 0 ▪ Signal asymmetry ▪ Exciter current 0 	Enter frequency output value in alarm condition.	0.0 to 12 500.0 Hz	0.0 Hz
Invert output signal	–	Invert the output signal.	<ul style="list-style-type: none"> ▪ No ▪ Yes 	No

* Visibility depends on order options or device settings

Configuring the switch output

Navigation

"Setup" menu → Pulse/frequency/switch output

► Pulse/frequency/switch output 1 to n		
Operating mode		→ ⓘ 111
Terminal number		→ ⓘ 111
Signal mode		→ ⓘ 111
Switch output function		→ ⓘ 112
Assign diagnostic behavior		→ ⓘ 112
Assign limit		→ ⓘ 112
Assign flow direction check		→ ⓘ 112
Assign status		→ ⓘ 112
Switch-on value		→ ⓘ 112
Switch-off value		→ ⓘ 112
Switch-on delay		→ ⓘ 112
Switch-off delay		→ ⓘ 113
Failure mode		→ ⓘ 113
Invert output signal		→ ⓘ 113

Parameter overview with brief description

Parameter	Prerequisite	Description	Selection / User interface / User entry	Factory setting
Operating mode	–	Define the output as a pulse, frequency or switch output.	<ul style="list-style-type: none"> ■ Pulse ■ Frequency ■ Switch 	Pulse
Terminal number	–	Shows the terminal numbers used by the PFS output module.	<ul style="list-style-type: none"> ■ Not used ■ 24-25 (I/O 2) ■ 22-23 (I/O 3) ■ 20-21 (I/O 4) * 	–
Signal mode	–	Select the signal mode for the PFS output.	<ul style="list-style-type: none"> ■ Passive ■ Active 	Passive

Parameter	Prerequisite	Description	Selection / User interface / User entry	Factory setting
Switch output function	In the Operating mode parameter the Switch option is selected.	Select function for switch output.	<ul style="list-style-type: none"> ▪ Off ▪ On ▪ Diagnostic behavior ▪ Limit ▪ Flow direction check ▪ Status 	Off
Assign diagnostic behavior	<ul style="list-style-type: none"> ▪ In the Operating mode parameter, the Switch option is selected. ▪ In the Switch output function parameter, the Diagnostic behavior option is selected. 	Select diagnostic behavior for switch output.	<ul style="list-style-type: none"> ▪ Alarm ▪ Alarm or warning ▪ Warning 	Alarm
Assign limit	<ul style="list-style-type: none"> ▪ In the Operating mode parameter, the Switch option is selected. ▪ In the Switch output function parameter, the Limit option is selected. 	Select process variable for limit function.	<ul style="list-style-type: none"> ▪ Mass flow ▪ Volume flow ▪ Corrected volume flow ▪ Target mass flow * ▪ Carrier mass flow * ▪ Density ▪ Reference density * ▪ Concentration * ▪ Temperature ▪ Totalizer 1 ▪ Totalizer 2 ▪ Totalizer 3 ▪ Oscillation damping 	Mass flow
Assign flow direction check	<ul style="list-style-type: none"> ▪ The Switch option is selected in the Operating mode parameter. ▪ The Flow direction check option is selected in the Switch output function parameter. 	Select process variable for flow direction monitoring.	<ul style="list-style-type: none"> ▪ Off ▪ Volume flow ▪ Mass flow ▪ Corrected volume flow 	Mass flow
Assign status	<ul style="list-style-type: none"> ▪ The Switch option is selected in the Operating mode parameter. ▪ The Status option is selected in the Switch output function parameter. 	Select device status for switch output.	<ul style="list-style-type: none"> ▪ Partially filled pipe detection ▪ Low flow cut off 	Partially filled pipe detection
Switch-on value	<ul style="list-style-type: none"> ▪ In the Operating mode parameter, the Switch option is selected. ▪ In the Switch output function parameter, the Limit option is selected. 	Enter measured value for the switch-on point.	Signed floating-point number	Country-specific: <ul style="list-style-type: none"> ▪ 0 kg/h ▪ 0 lb/min
Switch-off value	<ul style="list-style-type: none"> ▪ In the Operating mode parameter, the Switch option is selected. ▪ In the Switch output function parameter, the Limit option is selected. 	Enter measured value for the switch-off point.	Signed floating-point number	Country-specific: <ul style="list-style-type: none"> ▪ 0 kg/h ▪ 0 lb/min
Switch-on delay	<ul style="list-style-type: none"> ▪ The Switch option is selected in the Operating mode parameter. ▪ The Limit option is selected in the Switch output function parameter. 	Define delay for the switch-on of status output.	0.0 to 100.0 s	0.0 s

Parameter	Prerequisite	Description	Selection / User interface / User entry	Factory setting
Switch-off delay	<ul style="list-style-type: none"> ▪ The Switch option is selected in the Operating mode parameter. ▪ The Limit option is selected in the Switch output function parameter. 	Define delay for the switch-off of status output.	0.0 to 100.0 s	0.0 s
Failure mode	–	Define output behavior in alarm condition.	<ul style="list-style-type: none"> ▪ Actual status ▪ Open ▪ Closed 	Open
Invert output signal	–	Invert the output signal.	<ul style="list-style-type: none"> ▪ No ▪ Yes 	No

* Visibility depends on order options or device settings

10.4.9 Configuring the relay output

The **Relay output** wizard guides the user systematically through all the parameters that have to be set for configuring the relay output.

Navigation

"Setup" menu → Relay output 1 to n

▶ RelaisOutput 1 to n

Switch output function	→ 114
Assign flow direction check	→ 114
Assign limit	→ 114
Assign diagnostic behavior	→ 114
Assign status	→ 114
Switch-off value	→ 114
Switch-on value	→ 114
Failure mode	→ 114

Parameter overview with brief description

Parameter	Prerequisite	Description	Selection / User interface / User entry	Factory setting
Relay output function	–	Select the function for the relay output.	<ul style="list-style-type: none"> ▪ Closed ▪ Open ▪ Diagnostic behavior ▪ Limit ▪ Flow direction check ▪ Digital Output 	Closed
Terminal number	–	Shows the terminal numbers used by the relay output module.	<ul style="list-style-type: none"> ▪ Not used ▪ 24-25 (I/O 2) ▪ 22-23 (I/O 3) ▪ 20-21 (I/O 4) 	–
Assign flow direction check	In the Relay output function parameter, the Flow direction check option is selected.	Select process variable for flow direction monitoring.	<ul style="list-style-type: none"> ▪ Off ▪ Volume flow ▪ Mass flow ▪ Corrected volume flow 	Mass flow
Assign limit	In the Relay output function parameter, the Limit option is selected.	Select process variable for limit function.	<ul style="list-style-type: none"> ▪ Mass flow ▪ Volume flow ▪ Corrected volume flow ▪ Target mass flow[*] ▪ Carrier mass flow[*] ▪ Density ▪ Reference density[*] ▪ Concentration[*] ▪ Temperature ▪ Totalizer 1 ▪ Totalizer 2 ▪ Totalizer 3 ▪ Oscillation damping 	Mass flow
Assign diagnostic behavior	In the Relay output function parameter, the Diagnostic behavior option is selected.	Select diagnostic behavior for switch output.	<ul style="list-style-type: none"> ▪ Alarm ▪ Alarm or warning ▪ Warning 	Alarm
Assign status	In the Relay output function parameter, the Digital Output option is selected.	Select device status for switch output.	<ul style="list-style-type: none"> ▪ Partially filled pipe detection ▪ Low flow cut off 	Partially filled pipe detection
Switch-off value	In the Relay output function parameter, the Limit option is selected.	Enter measured value for the switch-off point.	Signed floating-point number	Country-specific: <ul style="list-style-type: none"> ▪ 0 kg/h ▪ 0 lb/min
Switch-off delay	In the Relay output function parameter, the Limit option is selected.	Define delay for the switch-off of status output.	0.0 to 100.0 s	0.0 s
Switch-on value	In the Relay output function parameter, the Limit option is selected.	Enter measured value for the switch-on point.	Signed floating-point number	Country-specific: <ul style="list-style-type: none"> ▪ 0 kg/h ▪ 0 lb/min
Switch-on delay	In the Relay output function parameter, the Limit option is selected.	Define delay for the switch-on of status output.	0.0 to 100.0 s	0.0 s
Failure mode	–	Define output behavior in alarm condition.	<ul style="list-style-type: none"> ▪ Actual status ▪ Open ▪ Closed 	Open

* Visibility depends on order options or device settings

10.4.10 Configuring the double pulse output

The **Double pulse output** submenu guides the user systematically through all the parameters that have to be set for configuring the double pulse output.

Navigation

"Setup" menu → Double pulse output

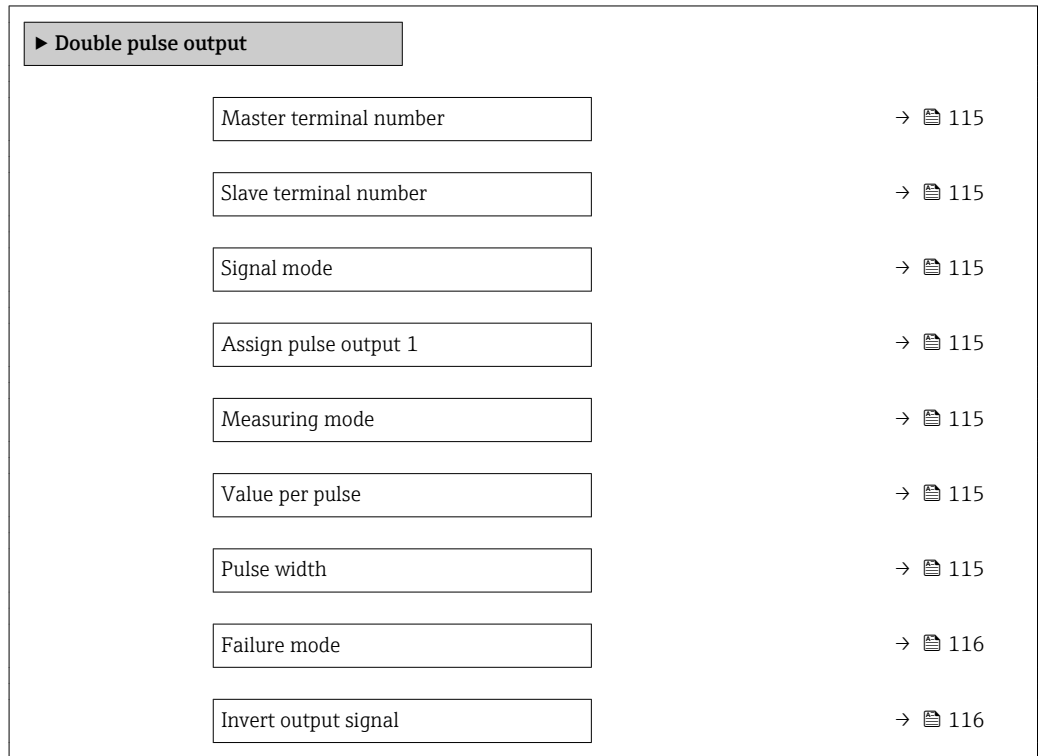

Parameter overview with brief description

Parameter	Description	Selection / User interface / User entry	Factory setting
Signal mode	Select the signal mode for the double pulse output.	<ul style="list-style-type: none"> ▪ Passive ▪ Active ▪ Passive NAMUR 	Passive
Master terminal number	Shows the terminal numbers used by the master of the double pulse output module.	<ul style="list-style-type: none"> ▪ Not used ▪ 24-25 (I/O 2) ▪ 22-23 (I/O 3) 	-
Slave terminal number		<ul style="list-style-type: none"> ▪ Not used ▪ 24-25 (I/O 2) ▪ 22-23 (I/O 3) 	-
Assign pulse output 1	Select process variable for pulse output.	<ul style="list-style-type: none"> ▪ Off ▪ Mass flow ▪ Volume flow ▪ Corrected volume flow ▪ Target mass flow * ▪ Carrier mass flow * 	Off
Measuring mode	Select measuring mode for pulse output.	<ul style="list-style-type: none"> ▪ Forward flow ▪ Forward/Reverse flow ▪ Reverse flow ▪ Reverse flow compensation 	Forward flow
Value per pulse	Enter measured value at which a pulse is output.	Signed floating-point number	Depends on country and nominal diameter
Pulse width	Define time width of the output pulse.	0.5 to 2 000 ms	0.5 ms

Parameter	Description	Selection / User interface / User entry	Factory setting
Failure mode	Define output behavior in alarm condition.	<ul style="list-style-type: none"> ■ Actual value ■ No pulses 	No pulses
Invert output signal	Invert the output signal.	<ul style="list-style-type: none"> ■ No ■ Yes 	No

* Visibility depends on order options or device settings

10.4.11 Configuring the local display

The **Display** wizard guides you systematically through all the parameters that can be configured for configuring the local display.



Navigation

"Setup" menu → Display

► Display	
Format display	→ ⓘ 117
Value 1 display	→ ⓘ 117
0% bargraph value 1	→ ⓘ 117
100% bargraph value 1	→ ⓘ 117
Value 2 display	→ ⓘ 118
Value 3 display	→ ⓘ 118
0% bargraph value 3	→ ⓘ 118
100% bargraph value 3	→ ⓘ 118
Value 4 display	→ ⓘ 118

Parameter overview with brief description

Parameter	Prerequisite	Description	Selection / User entry	Factory setting
Format display	A local display is provided.	Select how measured values are shown on the display.	<ul style="list-style-type: none"> ■ 1 value, max. size ■ 1 bargraph + 1 value ■ 2 values ■ 1 value large + 2 values ■ 4 values 	1 value, max. size
Value 1 display	A local display is provided.	Select the measured value that is shown on the local display.	<ul style="list-style-type: none"> ■ Mass flow ■ Volume flow ■ Corrected volume flow ■ Target mass flow * ■ Carrier mass flow * ■ Density ■ Reference density * ■ Concentration * ■ Temperature ■ Carrier pipe temperature * ■ Electronic temperature ■ Oscillation frequency 0 ■ Oscillation amplitude 0 * ■ Frequency fluctuation 0 ■ Oscillation damping 0 ■ Oscillation damping fluctuation 0 ■ Signal asymmetry ■ Exciter current 0 ■ Totalizer 1 ■ Totalizer 2 ■ Totalizer 3 ■ Current output 1 ■ Current output 2 * ■ Current output 3 * ■ Current output 4 * 	Mass flow
0% bargraph value 1	A local display is provided.	Enter 0% value for bar graph display.	Signed floating-point number	Country-specific: <ul style="list-style-type: none"> ■ 0 kg/h ■ 0 lb/min
100% bargraph value 1	A local display is provided.	Enter 100% value for bar graph display.	Signed floating-point number	Depends on country and nominal diameter

Parameter	Prerequisite	Description	Selection / User entry	Factory setting
Value 2 display	A local display is provided.	Select the measured value that is shown on the local display.	<ul style="list-style-type: none"> ▪ None ▪ Mass flow ▪ Volume flow ▪ Corrected volume flow ▪ Target mass flow * ▪ Carrier mass flow * ▪ Density ▪ Reference density ▪ Concentration * ▪ Temperature ▪ Carrier pipe temperature * ▪ Electronic temperature ▪ Oscillation frequency 0 ▪ Oscillation amplitude 0 * ▪ Frequency fluctuation 0 ▪ Oscillation damping 0 ▪ Oscillation damping fluctuation 0 ▪ Signal asymmetry ▪ Exciter current 0 ▪ Totalizer 1 ▪ Totalizer 2 ▪ Totalizer 3 ▪ Current output 1 ▪ Current output 2 * ▪ Current output 3 * ▪ Current output 4 * ▪ Custody transfer counter * 	None
Value 3 display	A local display is provided.	Select the measured value that is shown on the local display.	For the picklist, see the Value 2 display parameter (→  118)	None
0% bargraph value 3	A selection was made in the Value 3 display parameter.	Enter 0% value for bar graph display.	Signed floating-point number	Country-specific: <ul style="list-style-type: none"> ▪ 0 kg/h ▪ 0 lb/min
100% bargraph value 3	A selection was made in the Value 3 display parameter.	Enter 100% value for bar graph display.	Signed floating-point number	0
Value 4 display	A local display is provided.	Select the measured value that is shown on the local display.	For the picklist, see the Value 2 display parameter (→  118)	None

* Visibility depends on order options or device settings

10.4.12 Configuring the low flow cut off

The **Low flow cut off** wizard systematically guides the user through all the parameters that must be set to configure low flow cut off.

Navigation

"Setup" menu → Low flow cut off

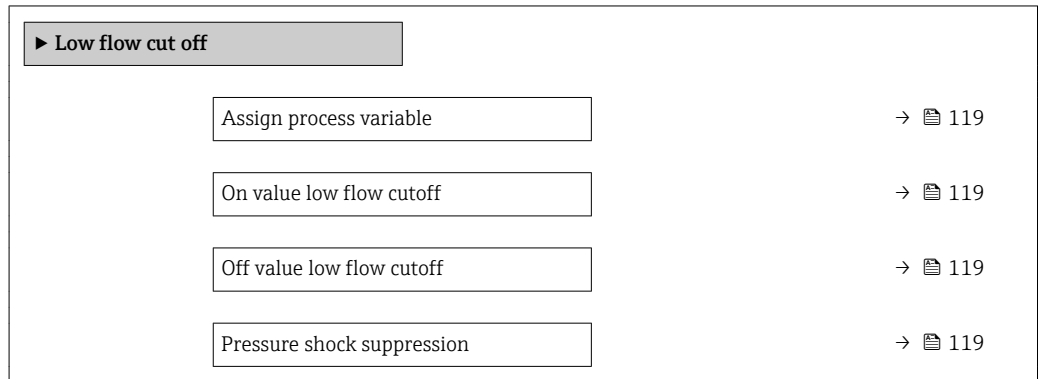

Parameter overview with brief description

Parameter	Prerequisite	Description	Selection / User entry	Factory setting
Assign process variable	–	Select process variable for low flow cut off.	<ul style="list-style-type: none"> ▪ Off ▪ Mass flow ▪ Volume flow ▪ Corrected volume flow 	Mass flow
On value low flow cutoff	One of the following options is selected in the Assign process variable parameter (→ 119): <ul style="list-style-type: none"> ▪ Mass flow ▪ Volume flow ▪ Corrected volume flow 	Enter on value for low flow cut off.	Positive floating-point number	Depends on country and nominal diameter
Off value low flow cutoff	One of the following options is selected in the Assign process variable parameter (→ 119): <ul style="list-style-type: none"> ▪ Mass flow ▪ Volume flow ▪ Corrected volume flow 	Enter off value for low flow cut off.	0 to 100.0 %	50 %
Pressure shock suppression	One of the following options is selected in the Assign process variable parameter (→ 119): <ul style="list-style-type: none"> ▪ Mass flow ▪ Volume flow ▪ Corrected volume flow 	Enter time frame for signal suppression (= active pressure shock suppression).	0 to 100 s	0 s

10.4.13 Configuring the partial filled pipe detection

The **Partial filled pipe detection** wizard guides you systematically through all parameters that have to be set for configuring the monitoring of the pipe filling.

Navigation

"Setup" menu → Partially filled pipe detection

► Partially filled pipe detection	
Assign process variable	→ ⓘ 120
Low value partial filled pipe detection	→ ⓘ 120
High value partial filled pipe detection	→ ⓘ 120
Response time part. filled pipe detect.	→ ⓘ 120

Parameter overview with brief description

Parameter	Prerequisite	Description	Selection / User entry	Factory setting
Assign process variable	–	Select process variable for partially filled pipe detection.	<ul style="list-style-type: none"> ■ Off ■ Density ■ Reference density 	Off
Low value partial filled pipe detection	One of the following options is selected in the Assign process variable parameter (→ ⓘ 120): <ul style="list-style-type: none"> ■ Density ■ Reference density 	Enter lower limit value for deactivating partially filled pipe detection.	Signed floating-point number	200
High value partial filled pipe detection	One of the following options is selected in the Assign process variable parameter (→ ⓘ 120): <ul style="list-style-type: none"> ■ Density ■ Reference density 	Enter upper limit value for deactivating partially filled pipe detection.	Signed floating-point number	6 000
Response time part. filled pipe detect.	One of the following options is selected in the Assign process variable parameter (→ ⓘ 120): <ul style="list-style-type: none"> ■ Density ■ Reference density 	Enter time before diagnostic message is displayed for partially filled pipe detection.	0 to 100 s	1 s

10.5 Advanced settings

The **Advanced setup** submenu together with its submenus contains parameters for specific settings.

Navigation to the "Advanced setup" submenu

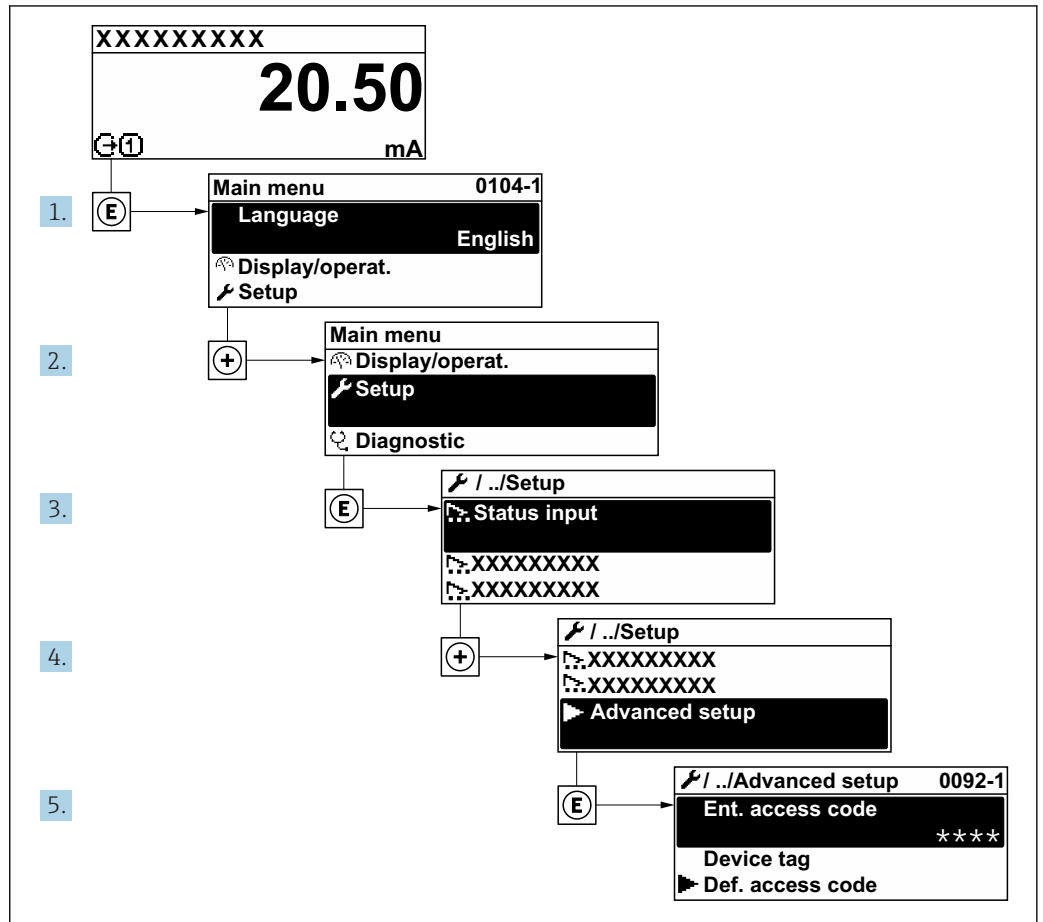

A0029564-EN

i The number of submenus can vary depending on the device version. Some submenus are not dealt with in the Operating Instructions. These submenus and the parameters they contain are explained in the Special Documentation for the device.

Navigation

"Setup" menu → Advanced setup

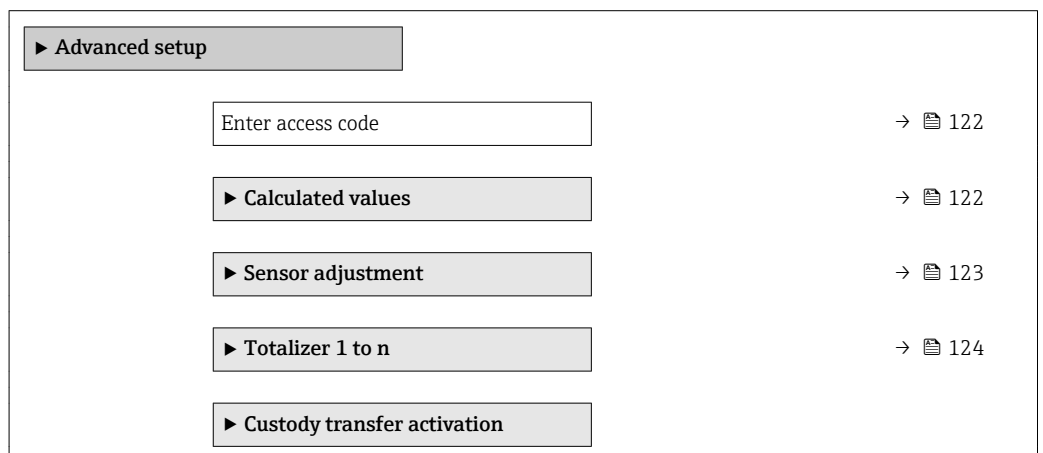

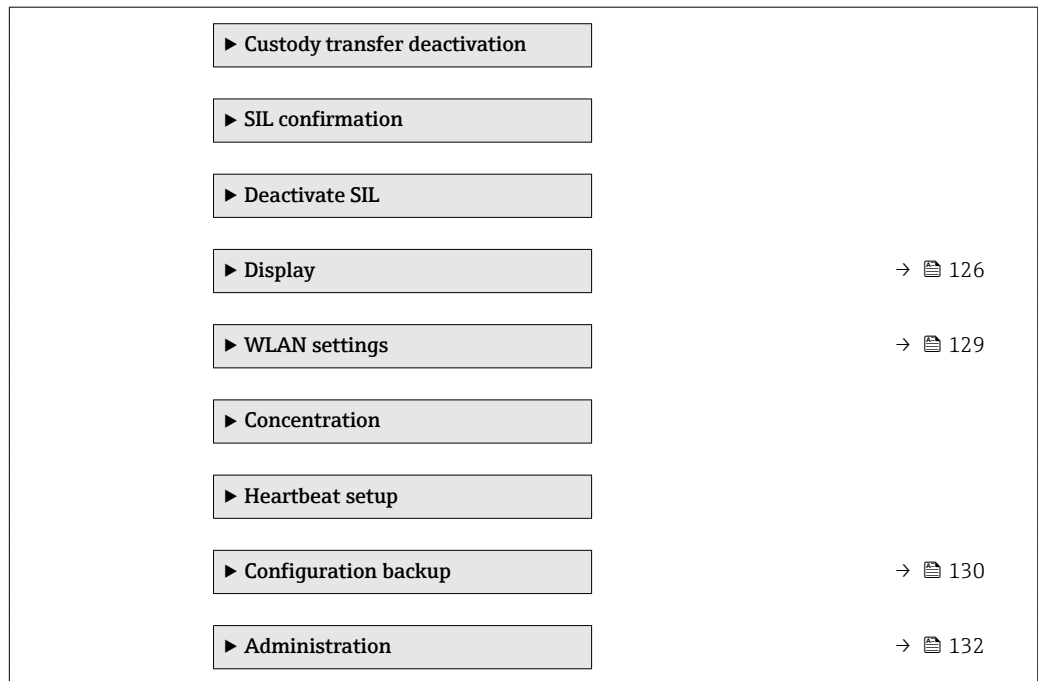

10.5.1 Using the parameter to enter the access code

Navigation

"Setup" menu → Advanced setup

Parameter overview with brief description

Parameter	Description	User entry
Enter access code	Enter access code to disable write protection of parameters.	0 to 9999

10.5.2 Calculated values

The **Calculated values** submenu contains parameters for calculating the corrected volume flow.

Navigation

"Setup" menu → Advanced setup → Calculated values

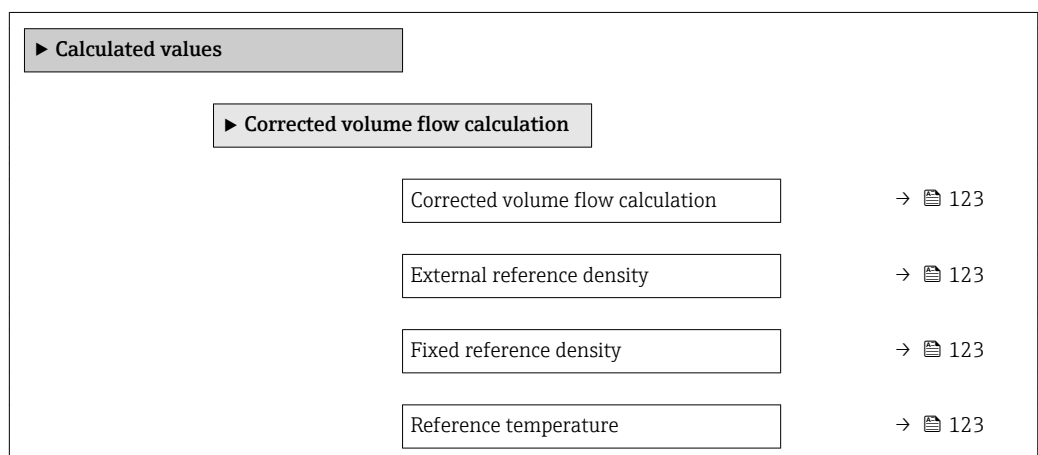

Linear expansion coefficient	→ 123
Square expansion coefficient	→ 123

Parameter overview with brief description

Parameter	Prerequisite	Description	Selection / User interface / User entry	Factory setting
Corrected volume flow calculation	–	Select reference density for calculating the corrected volume flow.	<ul style="list-style-type: none"> ■ Fixed reference density ■ Calculated reference density ■ Reference density by API table 53 ■ Current input 1 * ■ Current input 2 * ■ Current input 3 * 	Calculated reference density
External reference density	One of the following options is selected in the Corrected volume flow calculation parameter: <ul style="list-style-type: none"> ■ Current input 1 * ■ Current input 2 * ■ Current input 3 * 	Shows external reference density.	Floating point number with sign	–
Fixed reference density	The Fixed reference density option is selected in the Corrected volume flow calculation parameter.	Enter fixed value for reference density.	Positive floating-point number	1 kg/Nl
Reference temperature	The Calculated reference density option is selected in the Corrected volume flow calculation parameter.	Enter reference temperature for calculating the reference density.	–273.15 to 99 999 °C	Country-specific: <ul style="list-style-type: none"> ■ +20 °C ■ +68 °F
Linear expansion coefficient	The Calculated reference density option is selected in the Corrected volume flow calculation parameter.	Enter linear, medium-specific expansion coefficient for calculating the reference density.	Signed floating-point number	0.0
Square expansion coefficient	The Calculated reference density option is selected in the Corrected volume flow calculation parameter.	For media with a non-linear expansion pattern: enter the quadratic, medium-specific expansion coefficient for calculating the reference density.	Signed floating-point number	0.0

* Visibility depends on order options or device settings

10.5.3 Carrying out a sensor adjustment

The **Sensor adjustment** submenu contains parameters that pertain to the functionality of the sensor.

Navigation

"Setup" menu → Advanced setup → Sensor adjustment

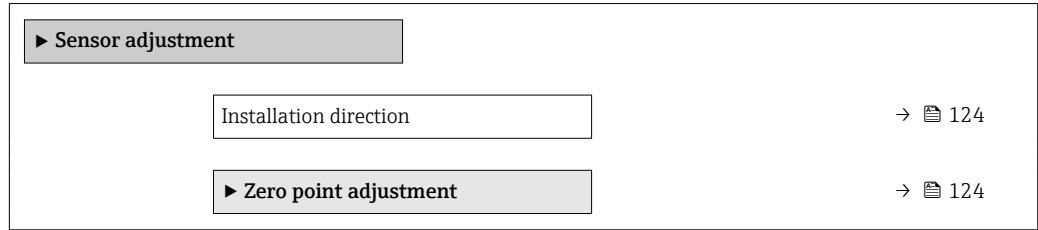

Parameter overview with brief description

Parameter	Description	Selection	Factory setting
Installation direction	Set sign of flow direction to match the direction of the arrow on the sensor.	<ul style="list-style-type: none"> ▪ Flow in arrow direction ▪ Flow against arrow direction 	Flow in arrow direction

Zero point adjustment

All measuring devices are calibrated in accordance with state-of-the-art technology. Calibration takes place under reference conditions → 190. Therefore, a zero point adjustment in the field is generally not required.

Experience shows that zero point adjustment is advisable only in special cases:

- To achieve maximum measuring accuracy even with low flow rates
- Under extreme process or operating conditions (e.g. very high process temperatures or very high-viscosity fluids).

Navigation

"Setup" menu → Advanced setup → Sensor adjustment → Zero point adjustment

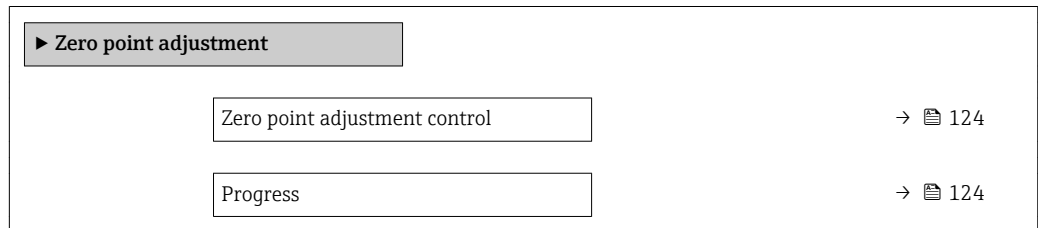

Parameter overview with brief description

Parameter	Description	Selection / User interface	Factory setting
Zero point adjustment control	Start zero point adjustment.	<ul style="list-style-type: none"> ▪ Cancel ▪ Busy ▪ Zero point adjust failure ▪ Start 	Cancel
Progress	Shows the progress of the process.	0 to 100 %	-

10.5.4 Configuring the totalizer

In the "Totalizer 1 to n" submenu the individual totalizer can be configured.

Navigation

"Setup" menu → Advanced setup → Totalizer 1 to n

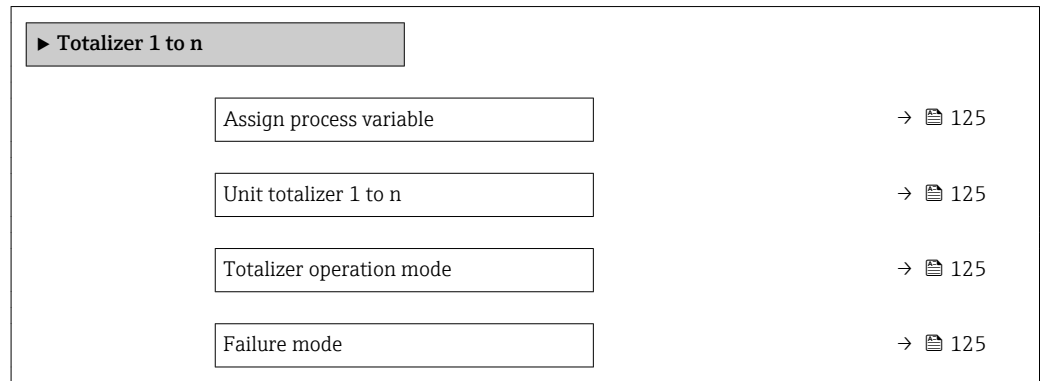

Parameter overview with brief description

Parameter	Prerequisite	Description	Selection	Factory setting
Assign process variable	–	Select process variable for totalizer.	<ul style="list-style-type: none"> ■ Off ■ Volume flow ■ Mass flow ■ Corrected volume flow ■ Target mass flow[*] ■ Carrier mass flow[*] 	Mass flow
Unit totalizer 1 to n	One of the following options is selected in the Assign process variable parameter (→ 125) Totalizer 1 to n submenu: <ul style="list-style-type: none"> ■ Volume flow ■ Mass flow ■ Corrected volume flow ■ Target mass flow[*] ■ Carrier mass flow[*] 	Select process variable totalizer unit.	Unit choose list	Country-specific: <ul style="list-style-type: none"> ■ kg ■ lb
Totalizer operation mode	One of the following options is selected in the Assign process variable parameter (→ 125) Totalizer 1 to n submenu: <ul style="list-style-type: none"> ■ Volume flow ■ Mass flow ■ Corrected volume flow ■ Target mass flow[*] ■ Carrier mass flow[*] 	Select totalizer calculation mode.	<ul style="list-style-type: none"> ■ Net flow total ■ Forward flow total ■ Reverse flow total 	Net flow total
Failure mode	One of the following options is selected in the Assign process variable parameter (→ 125) Totalizer 1 to n submenu: <ul style="list-style-type: none"> ■ Volume flow ■ Mass flow ■ Corrected volume flow ■ Target mass flow[*] ■ Carrier mass flow[*] 	Define totalizer behavior in alarm condition.	<ul style="list-style-type: none"> ■ Stop ■ Actual value ■ Last valid value 	Stop





















* Visibility depends on order options or device settings

10.5.5 Carrying out additional display configurations

In the **Display** submenu you can set all the parameters associated with the configuration of the local display.



Navigation

"Setup" menu → Advanced setup → Display

► Display	
Format display	→  127
Value 1 display	→  127
0% bargraph value 1	→  127
100% bargraph value 1	→  127
Decimal places 1	→  127
Value 2 display	→  128
Decimal places 2	→  128
Value 3 display	→  128
0% bargraph value 3	→  128
100% bargraph value 3	→  128
Decimal places 3	→  128
Value 4 display	→  128
Decimal places 4	→  129
Display language	→  129
Display interval	→  129
Display damping	→  129
Header	→  129
Header text	→  129
Separator	→  129
Backlight	→  129

Parameter overview with brief description

Parameter	Prerequisite	Description	Selection / User entry	Factory setting
Format display	A local display is provided.	Select how measured values are shown on the display.	<ul style="list-style-type: none"> ■ 1 value, max. size ■ 1 bargraph + 1 value ■ 2 values ■ 1 value large + 2 values ■ 4 values 	1 value, max. size
Value 1 display	A local display is provided.	Select the measured value that is shown on the local display.	<ul style="list-style-type: none"> ■ Mass flow ■ Volume flow ■ Corrected volume flow ■ Target mass flow * ■ Carrier mass flow * ■ Density ■ Reference density * ■ Concentration * ■ Temperature ■ Carrier pipe temperature * ■ Electronic temperature ■ Oscillation frequency 0 ■ Oscillation amplitude 0 * ■ Frequency fluctuation 0 ■ Oscillation damping 0 ■ Oscillation damping fluctuation 0 ■ Signal asymmetry ■ Exciter current 0 ■ Totalizer 1 ■ Totalizer 2 ■ Totalizer 3 ■ Current output 1 ■ Current output 2 * ■ Current output 3 * ■ Current output 4 * 	Mass flow
0% bargraph value 1	A local display is provided.	Enter 0% value for bar graph display.	Signed floating-point number	Country-specific: <ul style="list-style-type: none"> ■ 0 kg/h ■ 0 lb/min
100% bargraph value 1	A local display is provided.	Enter 100% value for bar graph display.	Signed floating-point number	Depends on country and nominal diameter
Decimal places 1	A measured value is specified in the Value 1 display parameter.	Select the number of decimal places for the display value.	<ul style="list-style-type: none"> ■ x ■ x.x ■ x.xx ■ x.xxx ■ x.xxxx 	x.xx

Parameter	Prerequisite	Description	Selection / User entry	Factory setting
Value 2 display	A local display is provided.	Select the measured value that is shown on the local display.	<ul style="list-style-type: none"> ▪ None ▪ Mass flow ▪ Volume flow ▪ Corrected volume flow ▪ Target mass flow * ▪ Carrier mass flow * ▪ Density ▪ Reference density ▪ Concentration * ▪ Temperature ▪ Carrier pipe temperature * ▪ Electronic temperature ▪ Oscillation frequency 0 ▪ Oscillation amplitude 0 * ▪ Frequency fluctuation 0 ▪ Oscillation damping 0 ▪ Oscillation damping fluctuation 0 ▪ Signal asymmetry ▪ Exciter current 0 ▪ Totalizer 1 ▪ Totalizer 2 ▪ Totalizer 3 ▪ Current output 1 ▪ Current output 2 * ▪ Current output 3 * ▪ Current output 4 * ▪ Custody transfer counter * 	None
Decimal places 2	A measured value is specified in the Value 2 display parameter.	Select the number of decimal places for the display value.	<ul style="list-style-type: none"> ▪ x ▪ x.x ▪ x.xx ▪ x.xxx ▪ x.xxxx 	x.xx
Value 3 display	A local display is provided.	Select the measured value that is shown on the local display.	For the picklist, see the Value 2 display parameter (→  118)	None
0% bargraph value 3	A selection was made in the Value 3 display parameter.	Enter 0% value for bar graph display.	Signed floating-point number	Country-specific: <ul style="list-style-type: none"> ▪ 0 kg/h ▪ 0 lb/min
100% bargraph value 3	A selection was made in the Value 3 display parameter.	Enter 100% value for bar graph display.	Signed floating-point number	0
Decimal places 3	A measured value is specified in the Value 3 display parameter.	Select the number of decimal places for the display value.	<ul style="list-style-type: none"> ▪ x ▪ x.x ▪ x.xx ▪ x.xxx ▪ x.xxxx 	x.xx
Value 4 display	A local display is provided.	Select the measured value that is shown on the local display.	For the picklist, see the Value 2 display parameter (→  118)	None

Parameter	Prerequisite	Description	Selection / User entry	Factory setting
Decimal places 4	A measured value is specified in the Value 4 display parameter.	Select the number of decimal places for the display value.	<ul style="list-style-type: none"> ■ x ■ x.x ■ x.xx ■ x.xxx ■ x.xxxx 	x.xx
Display language	A local display is provided.	Set display language.	<ul style="list-style-type: none"> ■ English ■ Deutsch * ■ Français * ■ Español * ■ Italiano * ■ Nederlands * ■ Portuguesa * ■ Polski * ■ русский язык (Russian) * ■ Svenska * ■ Türkçe * ■ 中文 (Chinese) * ■ 日本語 (Japanese) * ■ 한국어 (Korean) * ■ Bahasa Indonesia * ■ tiếng Việt (Vietnamese) * ■ čeština (Czech) * 	English (alternatively, the ordered language is preset in the device)
Display interval	A local display is provided.	Set time measured values are shown on display if display alternates between values.	1 to 10 s	5 s
Display damping	A local display is provided.	Set display reaction time to fluctuations in the measured value.	0.0 to 999.9 s	0.0 s
Header	A local display is provided.	Select header contents on local display.	<ul style="list-style-type: none"> ■ Device tag ■ Free text 	Device tag
Header text	In the Header parameter, the Free text option is selected.	Enter display header text.	Max. 12 characters such as letters, numbers or special characters (e.g. @, %, /)	-----
Separator	A local display is provided.	Select decimal separator for displaying numerical values.	<ul style="list-style-type: none"> ■ . (point) ■ , (comma) 	. (point)
Backlight	One of the following conditions is met: <ul style="list-style-type: none"> ■ Order code for "Display; operation", option F "4-line, illum.; touch control" ■ Order code for "Display; operation", option G "4-line, illum.; touch control +WLAN" 	Switch the local display backlight on and off.	<ul style="list-style-type: none"> ■ Disable ■ Enable 	Enable

* Visibility depends on order options or device settings

10.5.6 WLAN configuration



The **WLAN Settings** submenu guides the user systematically through all the parameters that have to be set for the WLAN configuration.

Navigation

"Setup" menu → Advanced setup → WLAN Settings

▶ WLAN settings	
WLAN IP address	→ ⓘ 130
Security type	→ ⓘ 130
WLAN passphrase	→ ⓘ 130
Assign SSID name	→ ⓘ 130
SSID name	→ ⓘ 130
Apply changes	→ ⓘ 130

Parameter overview with brief description

Parameter	Prerequisite	Description	User entry / Selection	Factory setting
WLAN IP address	–	Enter IP address of the device WLAN interface.	4 octet: 0 to 255 (in the particular octet)	192.168.1.212
Security type	–	Select the security type of the WLAN interface.	<ul style="list-style-type: none"> ▪ Unsecured ▪ WPA2-PSK 	WPA2-PSK
WLAN passphrase	In the Security type parameter, the WPA2-PSK option is selected.	Enter the network key (8 to 32 characters).  The network key supplied with the device should be changed during commissioning for security reasons.	8 to 32-digit character string comprising numbers, letters and special characters	Serial number of the measuring device (e.g. L100A802000)
Assign SSID name	–	Select which name will be used for SSID: device tag or user-defined name.	<ul style="list-style-type: none"> ▪ Device tag ▪ User-defined 	User-defined
SSID name	In the Assign SSID name parameter, the User-defined option is selected.	Enter the user-defined SSID name (max. 32 characters).  The user-defined SSID name may only be assigned once. If the SSID name is assigned more than once, the devices can interfere with one another.	Max. 32-digit character string comprising numbers, letters and special characters	EH_device designation_last 7 digits of the serial number (e.g. EH_Promass_500_A 802000)
Apply changes	–	Use changed WLAN settings.	<ul style="list-style-type: none"> ▪ Cancel ▪ Ok 	Cancel

10.5.7 Configuration management

After commissioning, you can save the current device configuration or restore the previous device configuration.

You can do so using the **Configuration management** parameter and the related options found in the **Configuration backup** submenu.

Navigation

"Setup" menu → Advanced setup → Configuration backup

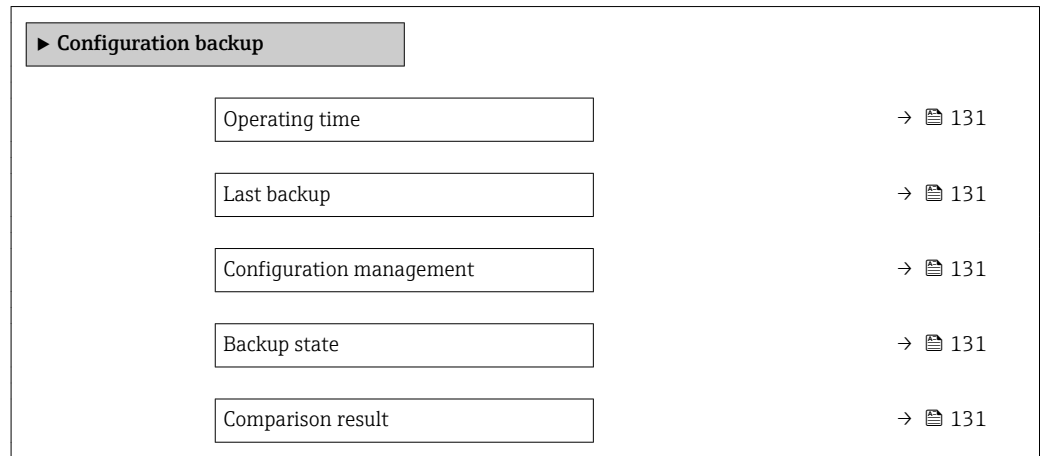

Parameter overview with brief description

Parameter	Description	User interface / Selection	Factory setting
Operating time	Indicates how long the device has been in operation.	Days (d), hours (h), minutes (m) and seconds (s)	–
Last backup	Shows when the last data backup was saved to embedded HistoROM.	Days (d), hours (h), minutes (m) and seconds (s)	–
Configuration management	Select action for managing the device data in the embedded HistoROM.	<ul style="list-style-type: none"> ■ Cancel ■ Execute backup ■ Restore ■ Compare ■ Clear backup data 	Cancel
Backup state	Shows the current status of data saving or restoring.	<ul style="list-style-type: none"> ■ None ■ Backup in progress ■ Restoring in progress ■ Delete in progress ■ Compare in progress ■ Restoring failed ■ Backup failed 	None
Comparison result	Comparison of current device data with embedded HistoROM.	<ul style="list-style-type: none"> ■ Settings identical ■ Settings not identical ■ No backup available ■ Backup settings corrupt ■ Check not done ■ Dataset incompatible 	Check not done

Function scope of the "Configuration management" parameter

Options	Description
Cancel	No action is executed and the user exits the parameter.
Execute backup	A backup copy of the current device configuration is saved from the integrated HistoROM to the memory of the device. The backup copy includes the transmitter data of the device.
Restore	The last backup copy of the device configuration is restored from the device memory to the device's integrated HistoROM. The backup copy includes the transmitter data of the device.

Options	Description
Compare	The device configuration saved in the device memory is compared with the current device configuration of the integrated HistoROM.
Clear backup data	The backup copy of the device configuration is deleted from the memory of the device.

 **Integrated HistoROM**
 A HistoROM is a "non-volatile" device memory in the form of an EEPROM.



 While this action is in progress, the configuration cannot be edited via the local display and a message on the processing status appears on the display.

10.5.8 Using parameters for device administration

The **Administration** submenu systematically guides the user through all the parameters that can be used for device administration purposes.

Navigation



"Setup" menu → Advanced setup → Administration

▶ Administration	
▶ Define access code	→  132
▶ Reset access code	→  133
Device reset	→  133

Using the parameter to define the access code

Navigation

"Setup" menu → Advanced setup → Administration → Define access code

▶ Define access code	
Define access code	→  132
Confirm access code	→  132

Parameter overview with brief description

Parameter	Description	User entry
Define access code	Restrict write-access to parameters to protect the configuration of the device against unintentional changes.	Max. 16-digit character string comprising numbers, letters and special characters
Confirm access code	Confirm the entered access code.	Max. 16-digit character string comprising numbers, letters and special characters

Using the parameter to reset the access code

Navigation

"Setup" menu → Advanced setup → Administration → Reset access code

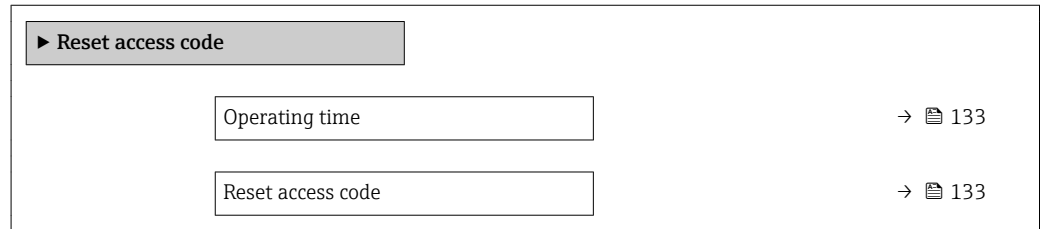

Parameter overview with brief description

Parameter	Description	User interface / User entry	Factory setting
Operating time	Indicates how long the device has been in operation.	Days (d), hours (h), minutes (m) and seconds (s)	-
Reset access code	Reset access code to factory settings.  For a reset code, contact your Endress+Hauser service organization. The reset code can only be entered via: <ul style="list-style-type: none"> ▪ Web browser ▪ DeviceCare, FieldCare (via service interface CDI-RJ45) ▪ Fieldbus 	Character string comprising numbers, letters and special characters	0x00

Using the parameter to reset the device

Navigation

"Setup" menu → Advanced setup → Administration

Parameter overview with brief description

Parameter	Description	Selection	Factory setting
Device reset	Reset the device configuration - either entirely or in part - to a defined state.	<ul style="list-style-type: none"> ▪ Cancel ▪ To delivery settings ▪ Restart device ▪ Restore S-DAT backup 	Cancel









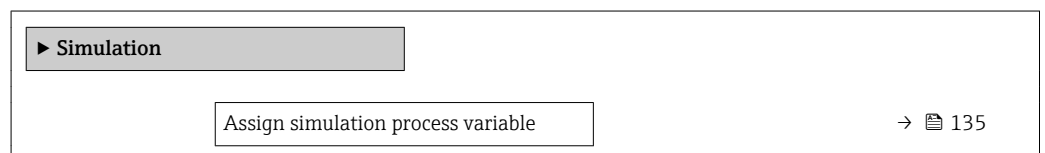











10.6 Simulation

The **Simulation** submenu enables you to simulate, without a real flow situation, various process variables in the process and the device alarm mode and to verify downstream signal chains (switching valves or closed-control loops).

Navigation

"Diagnostics" menu → Simulation



Process variable value	→  135
Status input simulation	→  135
Input signal level	→  135
Current input 1 to n simulation	→  135
Value current input 1 to n	→  135
Current output 1 to n simulation	→  135
Value current output 1 to n	→  135
Frequency output simulation 1 to n	→  135
Frequency value 1 to n	→  135
Pulse output simulation 1 to n	→  135
Pulse value 1 to n	→  135
Switch output simulation 1 to n	→  136
Switch status 1 to n	→  136
Relay output 1 to n simulation	→  136
Switch status 1 to n	→  136
Pulse output simulation	→  136
Pulse value	→  136
Device alarm simulation	→  136
Diagnostic event category	→  136
Diagnostic event simulation	→  136

Parameter overview with brief description



Parameter	Prerequisite	Description	Selection / User entry / User interface	Factory setting
Assign simulation process variable	–	Select a process variable for the simulation process that is activated.	<ul style="list-style-type: none"> ■ Off ■ Mass flow ■ Volume flow ■ Corrected volume flow ■ Density ■ Reference density ■ Temperature ■ Concentration * ■ Target mass flow * ■ Carrier mass flow * 	Off
Process variable value	One of the following options is selected in the Assign simulation process variable parameter (→ 135): <ul style="list-style-type: none"> ■ Mass flow ■ Volume flow ■ Corrected volume flow ■ Density ■ Reference density ■ Temperature ■ Concentration * ■ Target mass flow * ■ Carrier mass flow * 	Enter the simulation value for the selected process variable.	Depends on the process variable selected	0
Status input simulation	–	Switch simulation of the status input on and off.	<ul style="list-style-type: none"> ■ Off ■ On 	Off
Input signal level	In the Status input simulation parameter, the On option is selected.	Select the signal level for the simulation of the status input.	<ul style="list-style-type: none"> ■ High ■ Low 	High
Current input 1 to n simulation	–	Switch simulation of the current input on and off.	<ul style="list-style-type: none"> ■ Off ■ On 	Off
Value current input 1 to n	In the Current input 1 to n simulation parameter, the On option is selected.	Enter the current value for simulation.	0 to 22.5 mA	0 mA
Current output 1 to n simulation	–	Switch the simulation of the current output on and off.	<ul style="list-style-type: none"> ■ Off ■ On 	Off
Value current output 1 to n	In the Current output 1 to n simulation parameter, the On option is selected.	Enter the current value for simulation.	3.59 to 22.5 mA	3.59 mA
Frequency output simulation 1 to n	In the Operating mode parameter, the Frequency option is selected.	Switch the simulation of the frequency output on and off.	<ul style="list-style-type: none"> ■ Off ■ On 	Off
Frequency value 1 to n	In the Frequency output simulation 1 to n parameter, the On option is selected.	Enter the frequency value for the simulation.	0.0 to 12 500.0 Hz	0.0 Hz
Pulse output simulation 1 to n	In the Operating mode parameter, the Pulse option is selected.	Set and switch off the pulse output simulation.  For Fixed value option: Pulse width parameter (→ 105) defines the pulse width of the pulses output.	<ul style="list-style-type: none"> ■ Off ■ Fixed value ■ Down-counting value 	Off
Pulse value 1 to n	In the Pulse output simulation 1 to n parameter, the Down-counting value option is selected.	Enter the number of pulses for simulation.	0 to 65 535	0

Parameter	Prerequisite	Description	Selection / User entry / User interface	Factory setting
Switch output simulation 1 to n	In the Operating mode parameter, the Switch option is selected.	Switch the simulation of the switch output on and off.	<ul style="list-style-type: none"> ▪ Off ▪ On 	Off
Switch status 1 to n	–	Select the status of the status output for the simulation.	<ul style="list-style-type: none"> ▪ Open ▪ Closed 	Open
Relay output 1 to n simulation	–	Switch simulation of the relay output on and off.	<ul style="list-style-type: none"> ▪ Off ▪ On 	Off
Switch status 1 to n	In the Switch output simulation 1 to n parameter, the On option is selected.	Select status of the relay output for the simulation.	<ul style="list-style-type: none"> ▪ Open ▪ Closed 	Open
Pulse output simulation	–	Set and switch off the pulse output simulation.  For Fixed value option: Pulse width parameter defines the pulse width of the pulses output.	<ul style="list-style-type: none"> ▪ Off ▪ Fixed value ▪ Down-counting value 	Off
Pulse value	In the Pulse output simulation parameter, the Down-counting value option is selected.	Set and switch off the pulse output simulation.	0 to 65 535	0
Device alarm simulation	–	Switch the device alarm on and off.	<ul style="list-style-type: none"> ▪ Off ▪ On 	Off
Diagnostic event category	–	Select a diagnostic event category.	<ul style="list-style-type: none"> ▪ Sensor ▪ Electronics ▪ Configuration ▪ Process 	Process
Diagnostic event simulation	–	Select a diagnostic event to simulate this event.	<ul style="list-style-type: none"> ▪ Off ▪ Diagnostic event picklist (depends on the category selected) 	Off
Logging interval	–	Define the logging interval tlog for data logging. This value defines the time interval between the individual data points in the memory.	1.0 to 3 600.0 s	–

* Visibility depends on order options or device settings

10.7 Protecting settings from unauthorized access

The following write protection options exist in order to protect the configuration of the measuring device from unintentional modification:



- Protect access to parameters via access code →  136
- Protect access to local operation via key locking →  74
- Protect access to measuring device via write protection switch →  138

10.7.1 Write protection via access code



The effects of the user-specific access code are as follows:

- Via local operation, the parameters for the measuring device configuration are write-protected and their values can no longer be changed.
- Device access is protected via the Web browser, as are the parameters for the measuring device configuration.
- Device access is protected via FieldCare or DeviceCare (via CDI-RJ45 service interface), as are the parameters for the measuring device configuration.

Defining the access code via local display

1. Navigate to the **Define access code** parameter (→  132).
2. Define a max. 16-digit character string comprising numbers, letters and special characters as the access code.
3. Enter the access code again in the **Confirm access code** parameter (→  132) to confirm the code.
 - ↳ The -symbol appears in front of all write-protected parameters.

The device automatically locks the write-protected parameters again if a key is not pressed for 10 minutes in the navigation and editing view. The device locks the write-protected parameters automatically after 60 s if the user skips back to the operational display mode from the navigation and editing view.



-  If parameter write protection is activated via an access code, it can also only be deactivated via this access code →  74.
- The user role with which the user is currently logged on via the local display is indicated by the →  74 **Access status** parameter. Navigation path: Operation → Access status

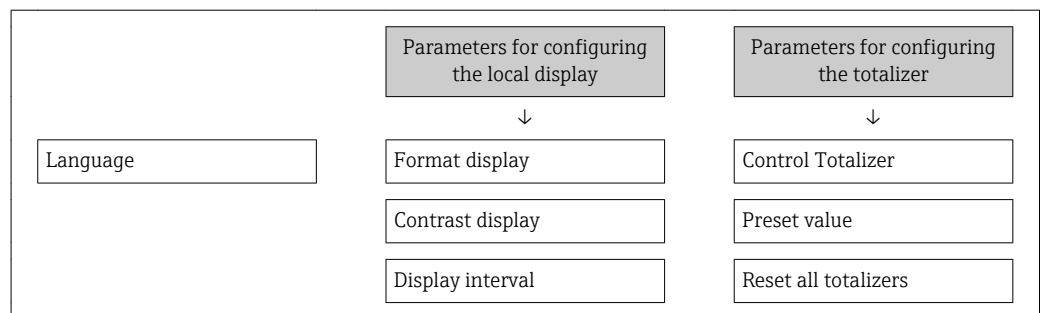

Parameters which can always be modified via the local display

Certain parameters that do not affect the measurement are excepted from parameter write protection via the local display. Despite the user-specific access code, they can always be modified, even if the other parameters are locked.



Defining the access code via the Web browser

1. Navigate to the **Define access code** parameter (→  132).
2. Max. Define a max. 4-digit numeric code as an access code.
3. Enter the access code again in the **Confirm access code** parameter (→  132) to confirm the code.
 - ↳ The Web browser switches to the login page.



-  If no action is performed for 10 minutes, the Web browser automatically returns to the login page.
-  If parameter write protection is activated via an access code, it can also only be deactivated via this access code →  74.
- The user role with which the user is currently logged on via Web browser is indicated by the **Access status** parameter. Navigation path: Operation → Access status

Resetting the access code

If you misplace the user-specific access code, it is possible to reset the code to the factory setting. A reset code must be entered for this purpose. The user-specific access code can then be defined again afterwards.

Via Web browser, FieldCare, DeviceCare (via CDI-RJ45 service interface), fieldbus

i For a reset code, contact your Endress+Hauser service organization.

1. Navigate to the **Reset access code** parameter (→  133).
2. Enter the reset code.
 - ↳ The access code has been reset to the factory setting **0000**. It can be redefined →  137.

10.7.2 Write protection via write protection switch

Unlike parameter write protection via a user-specific access code, this allows write access to the entire operating menu - except for the **"Contrast display" parameter** - to be locked.

The parameter values are now read only and cannot be edited any more (exception **"Contrast display" parameter**):

- Via local display
- Via HART protocol

Proline 500 – digital

⚠ WARNING

Excessive tightening torque applied to the fixing screws!

Risk of damaging the plastic transmitter.

- ▶ Tighten the fixing screws as per the tightening torque: 2 Nm (1.5 lbf ft).

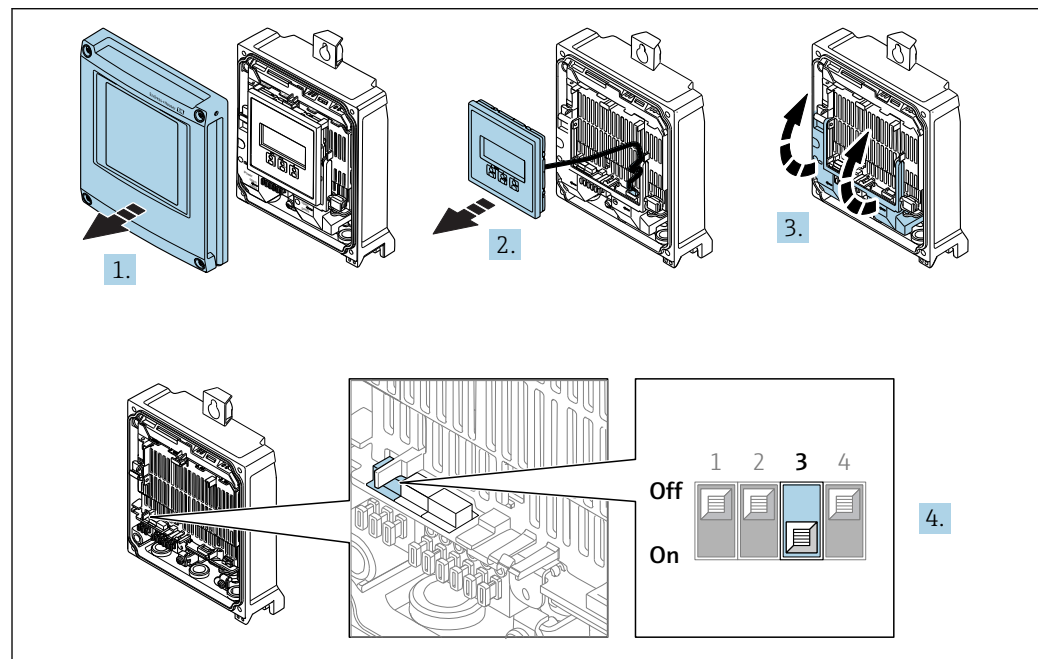

1. Open the housing cover.
2. Remove the display module.
3. Fold open the terminal cover.

4. Setting the write protection (WP) switch on the main electronics module to the **ON** position enables hardware write protection.
 - ↳ In the **Locking status** parameter the **Hardware locked** option is displayed → 140. In addition, on the local display the -symbol appears in front of the parameters in the header of the operational display and in the navigation view.

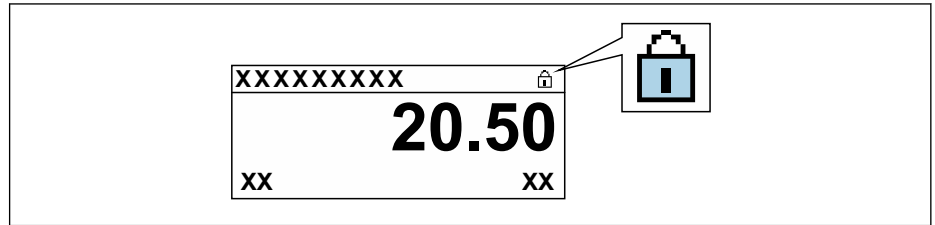

A0029425

5. Setting the write protection (WP) switch on the main electronics module to the **OFF** position (factory setting) disables hardware write protection.
 - ↳ No option is displayed in the **Locking status** parameter → 140. On the local display, the -symbol disappears from in front of the parameters in the header of the operational display and in the navigation view.

Proline 500

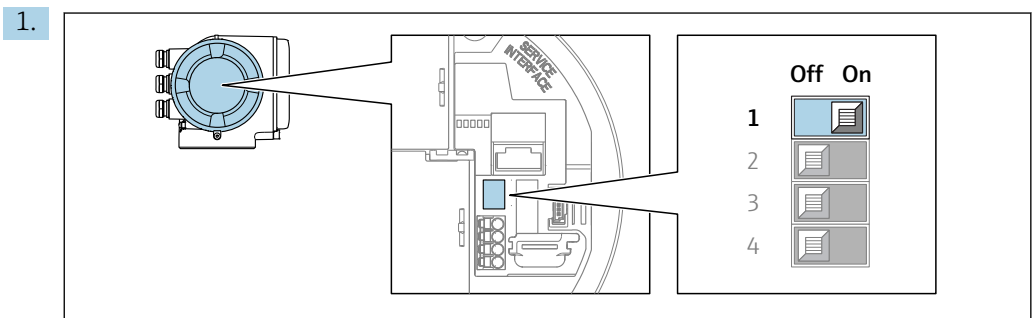

A0029630

Setting the write protection (WP) switch on the main electronics module to the **ON** position enables hardware write protection.

- ↳ In the **Locking status** parameter the **Hardware locked** option is displayed → 140. In addition, on the local display the -symbol appears in front of the parameters in the header of the operational display and in the navigation view.

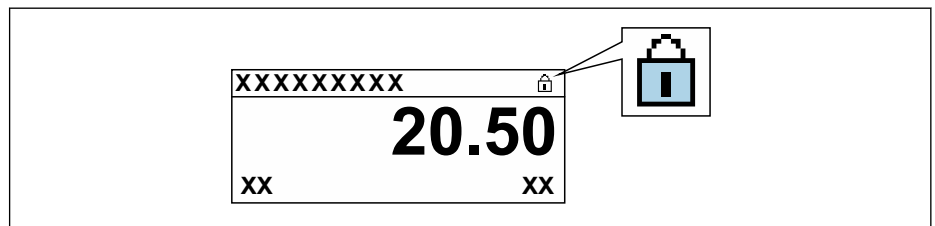

A0029425

2. Setting the write protection (WP) switch on the main electronics module to the **OFF** position (factory setting) disables hardware write protection.
 - ↳ No option is displayed in the **Locking status** parameter → 140. On the local display, the -symbol disappears from in front of the parameters in the header of the operational display and in the navigation view.



11 Operation

11.1 Reading the device locking status

Device active write protection: **Locking status** parameter



Operation → Locking status

Function scope of the "Locking status" parameter

Options	Description
None	The access status displayed in the Access status parameter applies →  74. Only appears on local display.
Hardware locked	The DIP switch for hardware locking is activated on the PCB board. This locks write access to the parameters (e.g. via local display or operating tool).
SIL locked	The SIL mode is enabled. This locks write access to the parameters (e.g. via local display or operating tool).
CT active - all parameters	The DIP switch for custody transfer mode is activated on the PCB board. This locks write access to all the parameters (e.g. via local display or operating tool).  For detailed information on custody transfer mode, see the Special Documentation for the device
CT active - defined parameters	The DIP switch for custody transfer mode is activated on the PCB board. This locks write access to the defined parameters (e.g. via local display or operating tool).  For detailed information on custody transfer mode, see the Special Documentation for the device
Temporarily locked	Write access to the parameters is temporarily locked on account of internal processes running in the device (e.g. data upload/download, reset etc.). Once the internal processing has been completed, the parameters can be changed once again.



11.2 Adjusting the operating language

 Detailed information:

- To configure the operating language →  92
- For information on the operating languages supported by the measuring device →  200

11.3 Configuring the display

Detailed information:

- On the basic settings for the local display →  116
- On the advanced settings for the local display →  126

11.4 Reading measured values

With the **Measured values** submenu, it is possible to read all the measured values.

Navigation

"Diagnostics" menu → Measured values

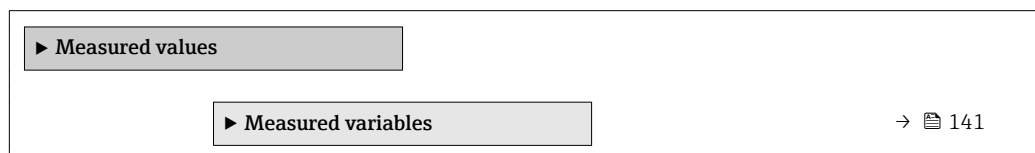

▶ Input values	→ 143
▶ Output values	→ 144
▶ Totalizer	→ 142

11.4.1 "Measured variables" submenu

The **Measured variables** submenu contains all the parameters needed to display the current measured values for each process variable.











Navigation

"Diagnostics" menu → Measured values → Measured variables

▶ Measured variables	
Mass flow	→ 141
Volume flow	→ 141
Corrected volume flow	→ 142
Density	→ 142
Reference density	→ 142
Temperature	→ 142
Pressure value	→ 142
Concentration	→ 142
Target mass flow	→ 142
Carrier mass flow	→ 142

Parameter overview with brief description

Parameter	Prerequisite	Description	User interface
Mass flow	–	Displays the mass flow currently measured. <i>Dependency</i> The unit is taken from the Mass flow unit parameter (→ 95).	Signed floating-point number
Volume flow	–	Displays the volume flow currently calculated. <i>Dependency</i> The unit is taken from the Volume flow unit parameter (→ 95).	Signed floating-point number

Parameter	Prerequisite	Description	User interface
Corrected volume flow	–	Displays the corrected volume flow currently calculated. <i>Dependency</i> The unit is taken from the Corrected volume flow unit parameter (→  95).	Signed floating-point number
Density	–	Shows the density currently measured. <i>Dependency</i> The unit is taken from the Density unit parameter (→  95).	Signed floating-point number
Reference density	–	Displays the reference density currently calculated. <i>Dependency</i> The unit is taken from the Reference density unit parameter (→  95).	Signed floating-point number
Temperature	–	Shows the medium temperature currently measured. <i>Dependency</i> The unit is taken from the Temperature unit parameter (→  96).	Signed floating-point number
Pressure value	–	Displays either a fixed or external pressure value. <i>Dependency</i> The unit is taken from the Pressure unit parameter (→  96).	Signed floating-point number
Concentration	For the following order code: "Application package", option ED "Concentration"  The software options currently enabled are displayed in the Software option overview parameter.	Displays the concentration currently calculated. <i>Dependency</i> The unit is taken from the Concentration unit parameter.	Signed floating-point number
Target mass flow	With the following conditions: ▪ Order code for "Application package", option ED "Concentration" ▪ The WT-% option or the User conc. option is selected in the Concentration unit parameter.  The software options currently enabled are displayed in the Software option overview parameter.	Displays the target fluid mass flow currently measured. <i>Dependency</i> The unit is taken from the Mass flow unit parameter (→  95).	Signed floating-point number
Carrier mass flow	With the following conditions: ▪ Order code for "Application package", option ED "Concentration" ▪ The WT-% option or the User conc. option is selected in the Concentration unit parameter.  The software options currently enabled are displayed in the Software option overview parameter.	Displays the carrier fluid mass flow currently measured. <i>Dependency</i> The unit is taken from the Mass flow unit parameter (→  95).	Signed floating-point number

11.4.2 "Totalizer" submenu

The **Totalizer** submenu contains all the parameters needed to display the current measured values for every totalizer.

Navigation

"Diagnostics" menu → Measured values → Totalizer

▶ **Totalizer**

Totalizer value 1 to n

→ ⓘ 143

Totalizer overflow 1 to n

→ ⓘ 143

Parameter overview with brief description

Parameter	Prerequisite	Description	User interface
Totalizer value 1 to n	A process variable is selected in the Assign process variable parameter (→ ⓘ 125) of the Totalizer 1 to n submenu.	Displays the current totalizer counter value.	Signed floating-point number
Totalizer overflow 1 to n	A process variable is selected in the Assign process variable parameter (→ ⓘ 125) of the Totalizer 1 to n submenu.	Displays the current totalizer overflow.	Integer with sign

11.4.3 "Input values" submenu

The **Input values** submenu guides you systematically to the individual input values.

Navigation

"Diagnostics" menu → Measured values → Input values

▶ **Input values**

▶ **Current input 1 to n**

→ ⓘ 143

▶ **Status input 1 to n**

→ ⓘ 144

Input values of current input

The **Current input 1 to n** submenu contains all the parameters needed to display the current measured values for every current input.

Navigation

"Diagnostics" menu → Measured values → Input values → Current input 1 to n

▶ **Current input 1 to n**

Measured values 1 to n

→ ⓘ 144

Measured current 1 to n

→ ⓘ 144

Parameter overview with brief description

Parameter	Description	User interface
Measured values 1 to n	Displays the current input value.	Signed floating-point number
Measured current 1 to n	Displays the current value of the current input.	0 to 22.5 mA

Input values of status input

The **Status input 1 to n** submenu contains all the parameters needed to display the current measured values for every status input.

Navigation

"Diagnostics" menu → Measured values → Input values → Status input 1 to n

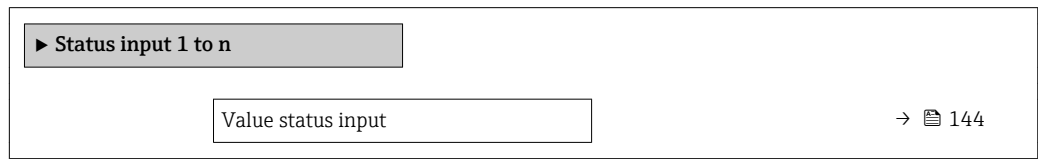

Parameter overview with brief description

Parameter	Description	User interface
Value status input	Shows the current input signal level.	<ul style="list-style-type: none"> ■ High ■ Low

11.4.4 Output values

The **Output values** submenu contains all the parameters needed to display the current measured values for every output.

Navigation

"Diagnostics" menu → Measured values → Output values

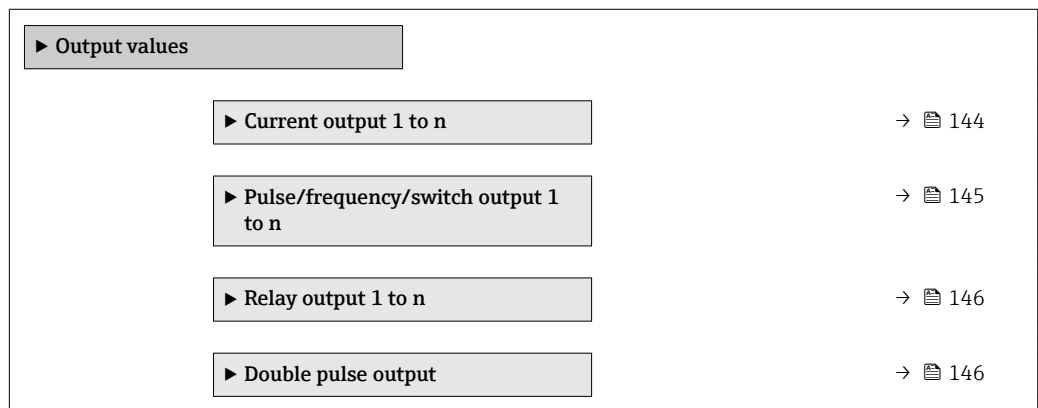

Output values of current output

The **Value current output** submenu contains all the parameters needed to display the current measured values for every current output.

Navigation

"Diagnostics" menu → Measured values → Output values → Value current output 1 to n

▶ **Current output 1 to n**

Output current 1 to n	→ ⓘ 145
Measured current 1 to n	→ ⓘ 145

Parameter overview with brief description

Parameter	Description	User interface
Output current 1	Displays the current value currently calculated for the current output.	3.59 to 22.5 mA
Measured current	Displays the current value currently measured for the current output.	0 to 30 mA

Output values for pulse/frequency/switch output

The **Pulse/frequency/switch output 1 to n** submenu contains all the parameters needed to display the current measured values for every pulse/frequency/switch output.

Navigation

"Diagnostics" menu → Measured values → Output values → Pulse/frequency/switch output 1 to n

▶ **Pulse/frequency/switch output 1 to n**

Output frequency 1 to n	→ ⓘ 146
Pulse output 1 to n	
Switch status 1 to n	→ ⓘ 146

Parameter overview with brief description

Parameter	Prerequisite	Description	User interface / User entry	Factory setting
Output frequency	In the Operating mode parameter, the Frequency option is selected.	Displays the value currently measured for the frequency output.	0.0 to 12 500.0 Hz	–
Value per pulse	In the Operating mode parameter, the Pulse option is selected and one of the following options is selected in the Assign pulse output parameter (→ 105): <ul style="list-style-type: none"> ▪ Mass flow ▪ Volume flow ▪ Corrected volume flow ▪ Target mass flow * ▪ Carrier mass flow * 	Enter measured value at which a pulse is output.	Signed floating-point number	Depends on country and nominal diameter
Switch status	The Switch option is selected in the Operating mode parameter.	Displays the current switch output status.	<ul style="list-style-type: none"> ▪ Open ▪ Closed 	–

* Visibility depends on order options or device settings

Output values for relay output

The **Relay output 1 to n** submenu contains all the parameters needed to display the current measured values for every relay output.

Navigation

"Diagnostics" menu → Measured values → Output values → Relay output 1 to n

▶ Relay output 1 to n	
Switch status	→ 146
Switch cycles	→ 146
Max. switch cycles number	→ 146

Parameter overview with brief description

Parameter	Description	User interface
Switch status	Shows the current relay switch status.	<ul style="list-style-type: none"> ▪ Open ▪ Closed
Switch cycles	Shows number of all performed switch cycles.	Positive integer
Max. switch cycles number	Shows the maximal number of guaranteed switch cycles.	Positive integer

Output values for double pulse output

The **Double pulse output** submenu contains all the parameters needed to display the current measured values for every double pulse output.

Navigation

"Diagnostics" menu → Measured values → Output values → Double pulse output

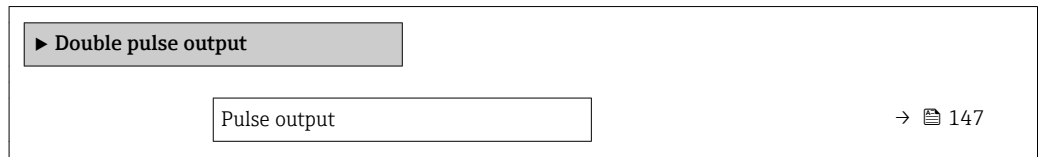

Parameter overview with brief description

Parameter	Description	User interface
Pulse output	Shows the currently output pulse frequency.	Positive floating-point number

11.5 Adapting the measuring device to the process conditions

The following are available for this purpose:

- Basic settings using the **Setup** menu (→ 📄 92)
- Advanced settings using the **Advanced setup** submenu (→ 📄 121)

11.6 Performing a totalizer reset

The totalizers are reset in the **Operation** submenu:



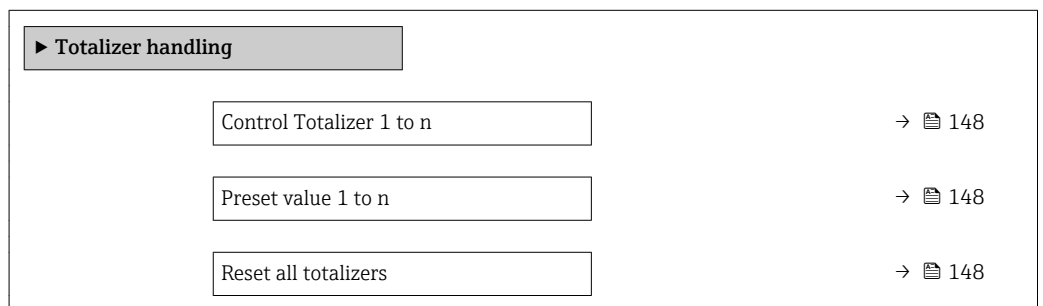

- Control Totalizer
- Reset all totalizers

Navigation

"Operation" menu → Totalizer handling



Parameter overview with brief description

Parameter	Prerequisite	Description	Selection / User entry	Factory setting
Control Totalizer 1 to n	One of the following options is selected in the Assign process variable parameter (→  125) Totalizer 1 to n submenu: <ul style="list-style-type: none"> ■ Volume flow ■ Mass flow ■ Corrected volume flow ■ Target mass flow * ■ Carrier mass flow * 	Control totalizer value.	<ul style="list-style-type: none"> ■ Totalize ■ Reset + hold ■ Preset + hold ■ Reset + totalize ■ Preset + totalize ■ Hold 	Totalize
Preset value 1 to n	One of the following options is selected in the Assign process variable parameter (→  125) Totalizer 1 to n submenu: <ul style="list-style-type: none"> ■ Volume flow ■ Mass flow ■ Corrected volume flow ■ Target mass flow * ■ Carrier mass flow * 	Specify start value for totalizer. <i>Dependency</i>  The unit of the selected process variable is specified for the totalizer in the Unit totalizer parameter (→  125).	Signed floating-point number	Country-specific: <ul style="list-style-type: none"> ■ 0 kg ■ 0 lb
Reset all totalizers	–	Reset all totalizers to 0 and start.	<ul style="list-style-type: none"> ■ Cancel ■ Reset + totalize 	Cancel

* Visibility depends on order options or device settings

11.6.1 Function scope of the "Control Totalizer" parameter



Options	Description
Totalize	The totalizer is started or continues running.
Reset + hold	The totaling process is stopped and the totalizer is reset to 0.
Preset + hold	The totaling process is stopped and the totalizer is set to its defined start value from the Preset value parameter.
Reset + totalize	The totalizer is reset to 0 and the totaling process is restarted.
Preset + totalize	The totalizer is set to the defined start value from the Preset value parameter and the totaling process is restarted.
Hold	Totalizing is stopped.

11.6.2 Function scope of the "Reset all totalizers" parameter

Options	Description
Cancel	No action is executed and the user exits the parameter.
Reset + totalize	Resets all totalizers to 0 and restarts the totaling process. This deletes all the flow values previously totaled.

11.7 Showing data logging

The **Extended HistoROM** application package must be enabled in the device (order option) for the **Data logging** submenu to appear. This contains all the parameters for the measured value history.

-  Data logging is also available via:
- Plant Asset Management Tool FieldCare →  84.
 - Web browser →  75

Function range

- A total of 1000 measured values can be stored
- 4 logging channels
- Adjustable logging interval for data logging
- Display of the measured value trend for each logging channel in the form of a chart

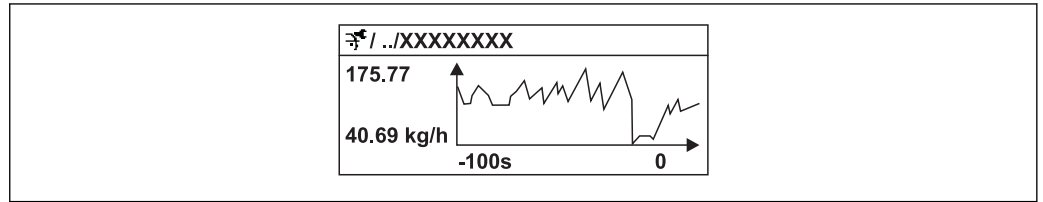

A0016357

37 Chart of a measured value trend

- x-axis: depending on the number of channels selected displays 250 to 1000 measured values of a process variable.
- y-axis: displays the approximate measured value span and constantly adapts this to the ongoing measurement.

i If the length of the logging interval or the assignment of the process variables to the channels is changed, the content of the data logging is deleted.

Navigation

"Diagnostics" menu → Data logging

► Data logging	
Assign channel 1...4	→ 150
Logging interval	→ 150
Clear logging data	→ 150
Data logging	→ 150
Logging delay	→ 150
Data logging control	→ 150
Data logging status	→ 150
Entire logging duration	→ 150

Parameter overview with brief description

Parameter	Prerequisite	Description	Selection / User entry / User interface	Factory setting
Assign channel 1 to n	The Extended HistorOM application package is available.	Assign process variable to logging channel.	<ul style="list-style-type: none"> ▪ Off ▪ Mass flow ▪ Volume flow ▪ Corrected volume flow ▪ Target mass flow * ▪ Carrier mass flow * ▪ Density ▪ Reference density ▪ Concentration * ▪ Temperature ▪ Carrier pipe temperature * ▪ Electronic temperature ▪ Oscillation frequency 0 ▪ Frequency fluctuation 0 ▪ Oscillation amplitude * ▪ Oscillation damping 0 ▪ Oscillation damping fluctuation 0 ▪ Signal asymmetry ▪ Exciter current 0 ▪ Current output 1 ▪ Current output 2 * ▪ Current output 3 * ▪ Current output 4 * 	Off
Logging interval	The Extended HistorOM application package is available.	Define the logging interval for data logging. This value defines the time interval between the individual data points in the memory.	0.1 to 999.0 s	1.0 s
Clear logging data	The Extended HistorOM application package is available.	Clear the entire logging data.	<ul style="list-style-type: none"> ▪ Cancel ▪ Clear data 	Cancel
Data logging	–	Select the data logging method.	<ul style="list-style-type: none"> ▪ Overwriting ▪ Not overwriting 	Overwriting
Logging delay	In the Data logging parameter, the Not overwriting option is selected.	Enter the time delay for measured value logging.	0 to 999 h	0 h
Data logging control	In the Data logging parameter, the Not overwriting option is selected.	Start and stop measured value logging.	<ul style="list-style-type: none"> ▪ None ▪ Delete + start ▪ Stop 	None
Data logging status	In the Data logging parameter, the Not overwriting option is selected.	Displays the measured value logging status.	<ul style="list-style-type: none"> ▪ Done ▪ Delay active ▪ Active ▪ Stopped 	Done
Entire logging duration	In the Data logging parameter, the Not overwriting option is selected.	Displays the total logging duration.	Positive floating-point number	0 s

* Visibility depends on order options or device settings

12 Diagnostics and troubleshooting

12.1 General troubleshooting

For local display

Error	Possible causes	Solution
Local display dark and no output signals	Supply voltage does not match the value indicated on the nameplate.	Apply the correct supply voltage .
Local display dark and no output signals	The polarity of the supply voltage is wrong.	Correct the polarity.
Local display dark and no output signals	No contact between connecting cables and terminals.	Check the connection of the cables and correct if necessary.
Local display dark and no output signals	Terminals are not plugged into the I/O electronics module correctly. Terminals are not plugged into the main electronics module correctly.	Check terminals.
Local display dark and no output signals	I/O electronics module is defective. Main electronics module is defective.	Order spare part → ☰ 175.
Local display dark and no output signals	The connector between the main electronics module and display module is not plugged in correctly.	Check the connection and correct if necessary.
Local display dark and no output signals	The connecting cable is not plugged in correctly.	<ol style="list-style-type: none"> 1. Check the connection of the electrode cable and correct if necessary. 2. Check the connection of the coil current cable and correct if necessary.
Local display is dark, but signal output is within the valid range	Display is set too bright or too dark.	<ul style="list-style-type: none"> ▪ Set the display brighter by simultaneously pressing ☐ + ☒. ▪ Set the display darker by simultaneously pressing ☐ + ☓.
Local display is dark, but signal output is within the valid range	The cable of the display module is not plugged in correctly.	Insert the plug correctly into the main electronics module and display module.
Local display is dark, but signal output is within the valid range	Display module is defective.	Order spare part → ☰ 175.
Backlighting of local display is red	Diagnostic event with "Alarm" diagnostic behavior has occurred.	Take remedial measures
Text on local display appears in a foreign language and cannot be understood.	Incorrect operating language is configured.	<ol style="list-style-type: none"> 1. Press ☐ + ☐ for 2 s ("home position"). 2. Press ☒. 3. Set the desired language in the Display language parameter (→ ☰ 129).
Message on local display: "Communication Error" "Check Electronics"	Communication between the display module and the electronics is interrupted.	<ul style="list-style-type: none"> ▪ Check the cable and the connector between the main electronics module and display module. ▪ Order spare part → ☰ 175.

For output signals

Error	Possible causes	Solution
Signal output outside the valid range	Main electronics module is defective.	Order spare part → 175.
Signal output outside the valid current range (< 3.6 mA or > 22 mA)	Main electronics module is defective. I/O electronics module is defective.	Order spare part → 175.
Device shows correct value on local display, but signal output is incorrect, though in the valid range.	Configuration error	Check and correct the parameter configuration.
Device measures incorrectly.	Configuration error or device is operated outside the application.	1. Check and correct parameter configuration. 2. Observe limit values specified in the "Technical Data".

For access

Error	Possible causes	Solution
No write access to parameters	Hardware write protection enabled	Set the write protection switch on main electronics module to the Off position → 138.
No write access to parameters	Current user role has limited access authorization	1. Check user role → 74. 2. Enter correct customer-specific access code → 74.
No connection via HART protocol	Communication resistor missing or incorrectly installed.	Install the communication resistor (250 Ω) correctly. Observe the maximum load → 184.
No connection via HART protocol	Commubox <ul style="list-style-type: none"> ▪ Connected incorrectly ▪ Configured incorrectly ▪ Drivers not installed correctly ▪ USB interface on computer configured incorrectly 	Observe the documentation for the Commubox.  FXA195 HART: Document "Technical Information" TI00404F
Not connecting to Web server	Web server disabled	Using the "FieldCare" or "DeviceCare" operating tool, check whether the web server of the measuring device is enabled, and enable it if necessary → 80.
	Incorrect setting for the Ethernet interface of the computer	1. Check the properties of the Internet protocol (TCP/IP) → 77. 2. Check the network settings with the IT manager.
Not connecting to Web server	Incorrect IP address	Check the IP address: 192.168.1.212 → 77
Not connecting to Web server	Incorrect WLAN access data	<ul style="list-style-type: none"> ▪ Check WLAN network status. ▪ Log on to the device again using WLAN access data. ▪ Verify that WLAN is enabled on the measuring device and operating device → 77.
	WLAN communication disabled	–
Not connecting to web server, FieldCare or DeviceCare	No WLAN network available	<ul style="list-style-type: none"> ▪ Check if WLAN reception is present: LED on display module is lit blue ▪ Check if WLAN connection is enabled: LED on display module flashes blue ▪ Switch on instrument function.

Error	Possible causes	Solution
Network connection not present or unstable	WLAN network is weak.	<ul style="list-style-type: none"> ▪ Operating device is outside of reception range: Check network status on operating device. ▪ To improve network performance, use an external WLAN antenna.
	Parallel WLAN and Ethernet communication	<ul style="list-style-type: none"> ▪ Check network settings. ▪ Temporarily enable only the WLAN as an interface.
Web browser frozen and operation no longer possible	Data transfer active	Wait until data transfer or current action is finished.
	Connection lost	<ol style="list-style-type: none"> 1. Check cable connection and power supply. 2. Refresh the Web browser and restart if necessary.
Content of Web browser incomplete or difficult to read	Not using optimum version of Web server.	<ol style="list-style-type: none"> 1. Use the correct Web browser version . 2. Clear the Web browser cache and restart the Web browser.
	Unsuitable view settings.	Change the font size/display ratio of the Web browser.
No or incomplete display of contents in the Web browser	<ul style="list-style-type: none"> ▪ JavaScript not enabled ▪ JavaScript cannot be enabled 	<ol style="list-style-type: none"> 1. Enable JavaScript. 2. Enter http://XXX.XXX.X.XXX/basic.html as the IP address.
Operation with FieldCare or DeviceCare via CDI-RJ45 service interface (port 8000)	Firewall of computer or network is preventing communication	Depending on the settings of the firewall used on the computer or in the network, the firewall must be adapted or disabled to allow FieldCare/DeviceCare access.
Flashing of firmware with FieldCare or DeviceCare via CDI-RJ45 service interface (via port 8000 or TFTP ports)	Firewall of computer or network is preventing communication	Depending on the settings of the firewall used on the computer or in the network, the firewall must be adapted or disabled to allow FieldCare/DeviceCare access.

12.2 Diagnostic information via light emitting diodes

12.2.1 Transmitter

Proline 500 – digital

Different LEDs in the transmitter provide information on the device status.

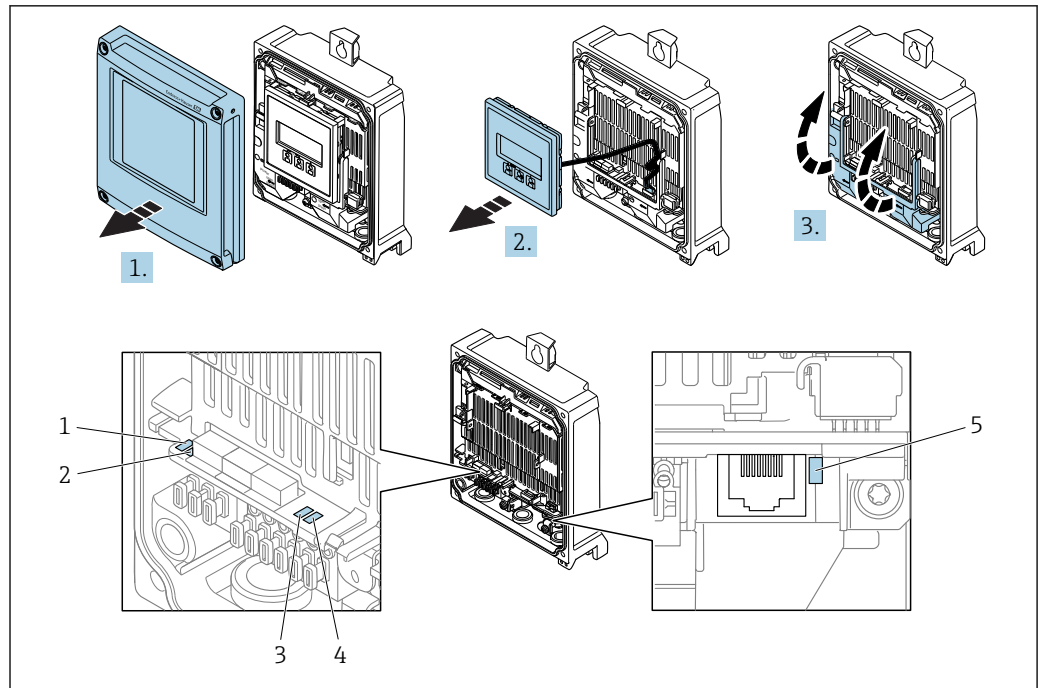

A0029689

- 1 Supply voltage
- 2 Device status
- 3 Not used
- 4 Communication
- 5 Service interface (CDI) active

1. Open the housing cover.
2. Remove the display module.
3. Fold open the terminal cover.

LED	Color	Meaning
1 Supply voltage	Green	Supply voltage is ok
	Off	Supply voltage is off or too low
2 Device status	Green	Device is OK
	Red	Error
	Flashing red	Warning
3 Not used	-	-
4 Communication	Flashing white	Communication active
5 Service interface (CDI)	Yellow	Connection established
	Flashing yellow	Communication active
	Off	No connection

Proline 500

Different LEDs in the transmitter provide information on the device status.

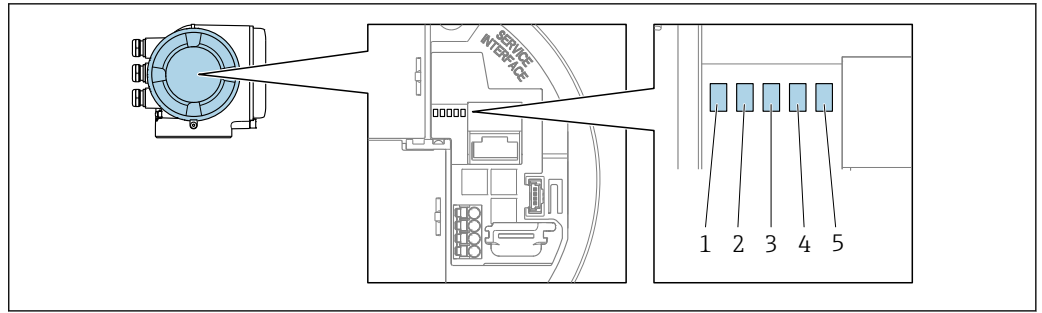

A0029629

- 1 Supply voltage
- 2 Device status
- 3 Not used
- 4 Communication
- 5 Service interface (CDI) active

LED	Color	Meaning
1 Supply voltage	Green	Supply voltage is ok
	Off	Supply voltage is off or too low
2 Device status	Red	Error
	Flashing red	Warning
3 Not used	–	–
4 Communication	White	Communication active
5 Service interface (CDI)	Yellow	Connection established
	Flashing yellow	Communication active
	Off	No connection

12.2.2 Sensor connection housing

Proline 500 – digital

Various light emitting diodes (LED) on the ISEM electronics (Intelligent Sensor Electronic Module) in the sensor connection housing provide information on the device status.

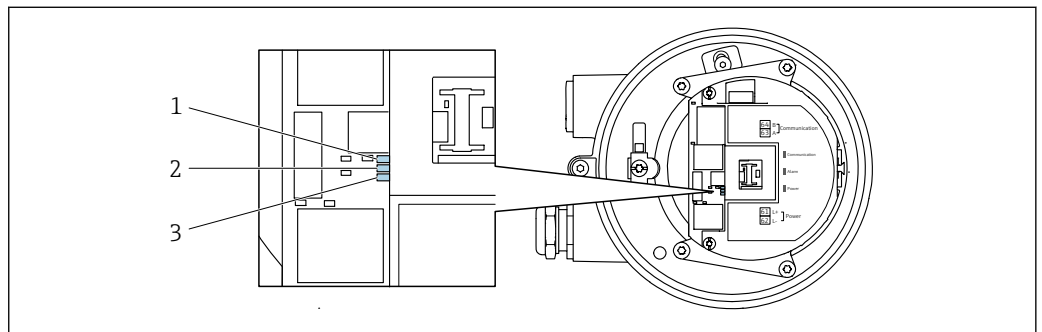

A0029699

- 1 Communication
- 2 Device status
- 3 Supply voltage

LED	Color	Meaning
1 Communication	White	Communication active
2 Device status	Red	Error
	Flashing red	Warning

LED	Color	Meaning
3 Supply voltage	Green	Supply voltage is ok
	Off	Supply voltage is off or too low

12.3 Diagnostic information on local display

12.3.1 Diagnostic message

Faults detected by the self-monitoring system of the measuring device are displayed as a diagnostic message in alternation with the operational display.

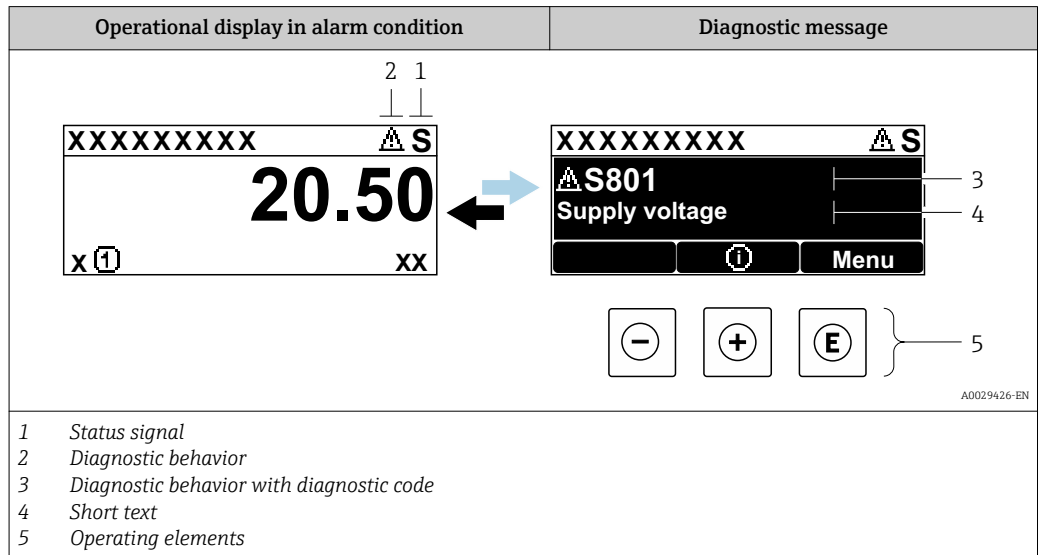

If two or more diagnostic events are pending simultaneously, only the message of the diagnostic event with the highest priority is shown.

- i** Other diagnostic events that have occurred can be displayed in the **Diagnostics** menu:
 - Via parameter
 - Via submenus → 168



Status signals

The status signals provide information on the state and reliability of the device by categorizing the cause of the diagnostic information (diagnostic event).

- i** The status signals are categorized according to VDI/VDE 2650 and NAMUR Recommendation NE 107: F = Failure, C = Function Check, S = Out of Specification, M = Maintenance Required

Symbol	Meaning
F	Failure A device error has occurred. The measured value is no longer valid.
C	Function check The device is in service mode (e.g. during a simulation).
S	Out of specification The device is operated: <ul style="list-style-type: none"> ▪ Outside its technical specification limits (e.g. outside the process temperature range) ▪ Outside of the configuration carried out by the user (e.g. maximum flow in parameter 20 mA value)
M	Maintenance required Maintenance is required. The measured value remains valid.

Diagnostic behavior



Symbol	Meaning
	Alarm <ul style="list-style-type: none"> ▪ Measurement is interrupted. ▪ Signal outputs and totalizers assume the defined alarm condition. ▪ A diagnostic message is generated.
	Warning Measurement is resumed. The signal outputs and totalizers are not affected. A diagnostic message is generated.

Diagnostic information

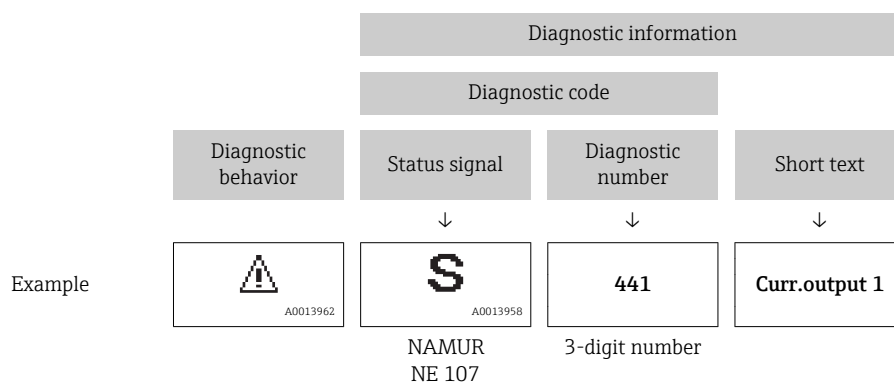
The fault can be identified using the diagnostic information. The short text helps you by providing information about the fault. In addition, the corresponding symbol for the diagnostic behavior is displayed in front of the diagnostic information on the local display.



Operating elements

Key	Meaning
	Plus key <i>In a menu, submenu</i> Opens the message about remedy information.
	Enter key <i>In a menu, submenu</i> Opens the operating menu.

12.3.2 Calling up remedial measures

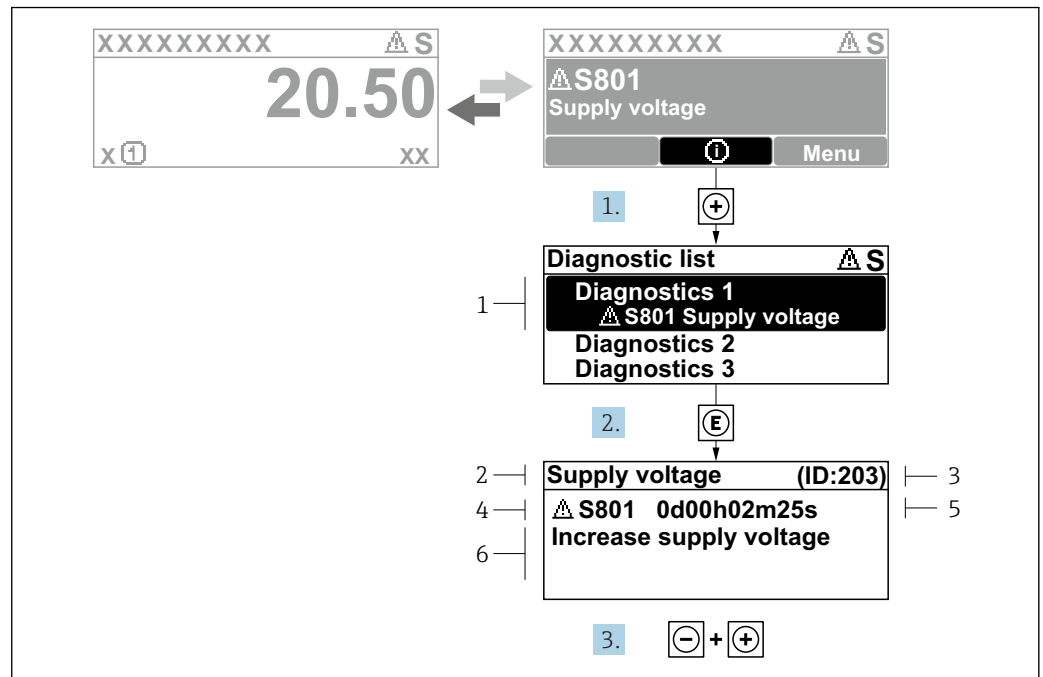

38 Message for remedial measures

- 1 Diagnostic information
- 2 Short text
- 3 Service ID
- 4 Diagnostic behavior with diagnostic code
- 5 Operation time of occurrence
- 6 Remedial measures

The user is in the diagnostic message.

1. Press \oplus ($\textcircled{+}$ symbol).
 - ↳ The **Diagnostic list** submenu opens.
2. Select the desired diagnostic event with \oplus or \ominus and press $\text{\textcircled{E}}$.
 - ↳ The message for the remedial measures for the selected diagnostic event opens.
3. Press $\ominus + \oplus$ simultaneously.
 - ↳ The message for the remedial measures closes.

The user is in the **Diagnostics** menu at an entry for a diagnostics event, e.g. in the **Diagnostic list** submenu or **Previous diagnostics** parameter.

1. Press $\text{\textcircled{E}}$.
 - ↳ The message for the remedial measures for the selected diagnostic event opens.
2. Press $\ominus + \oplus$ simultaneously.
 - ↳ The message for the remedial measures closes.

12.4 Diagnostic information in the Web browser

12.4.1 Diagnostic options

Any faults detected by the measuring device are displayed in the Web browser on the home page once the user has logged on.

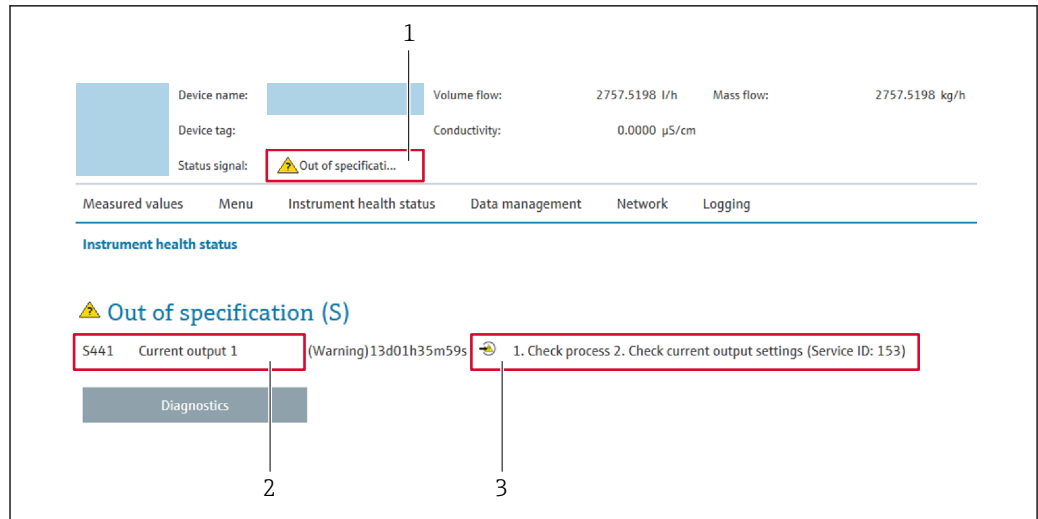

A0031056

- 1 Status area with status signal
- 2 Diagnostic information → 158
- 3 Remedy information with Service ID

i In addition, diagnostic events which have occurred can be shown in the **Diagnostics** menu:

- Via parameter
- Via submenu → 168

Status signals

The status signals provide information on the state and reliability of the device by categorizing the cause of the diagnostic information (diagnostic event).

Symbol	Meaning
	Failure A device error has occurred. The measured value is no longer valid.
	Function check The device is in service mode (e.g. during a simulation).
	Out of specification The device is operated: <ul style="list-style-type: none"> ▪ Outside its technical specification limits (e.g. outside the process temperature range) ▪ Outside of the configuration carried out by the user (e.g. maximum flow in parameter 20 mA value)
	Maintenance required Maintenance is required. The measured value is still valid.

i The status signals are categorized in accordance with VDI/VDE 2650 and NAMUR Recommendation NE 107.

12.4.2 Calling up remedy information

Remedy information is provided for every diagnostic event to ensure that problems can be rectified quickly. These measures are displayed in red along with the diagnostic event and the related diagnostic information.

12.5 Diagnostic information in DeviceCare or FieldCare

12.5.1 Diagnostic options

Any faults detected by the measuring device are displayed on the home page of the operating tool once the connection has been established.

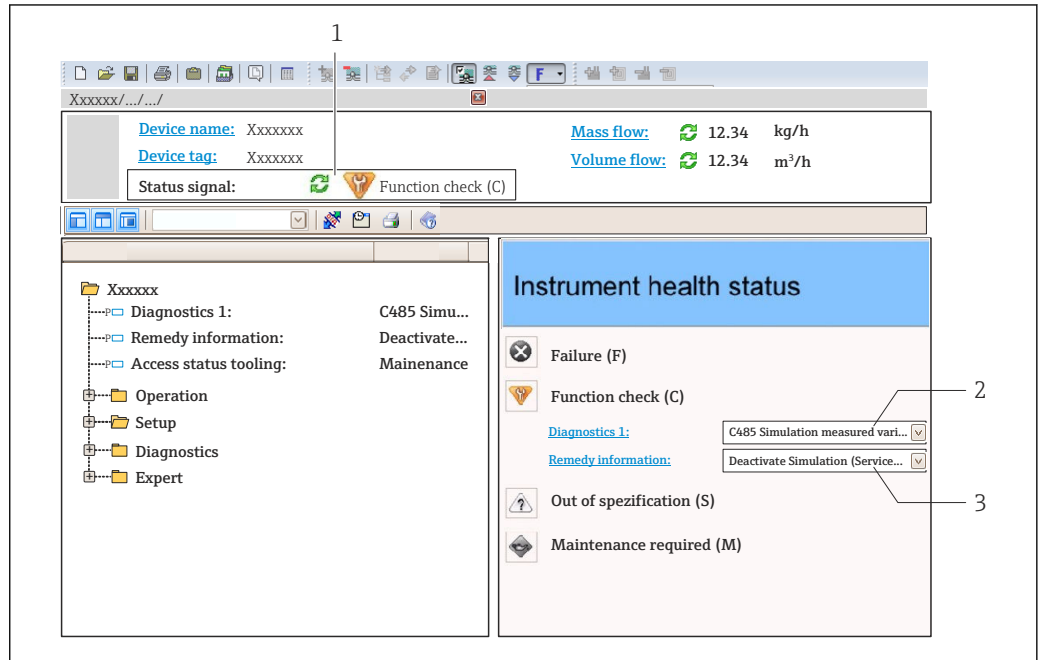

- 1 Status area with status signal → 157
- 2 Diagnostic information → 158
- 3 Remedy information with Service ID

i In addition, diagnostic events which have occurred can be shown in the **Diagnostics** menu:

- Via parameter
- Via submenu → 168

Diagnostic information

The fault can be identified using the diagnostic information. The short text helps you by providing information about the fault. In addition, the corresponding symbol for the diagnostic behavior is displayed in front of the diagnostic information on the local display.

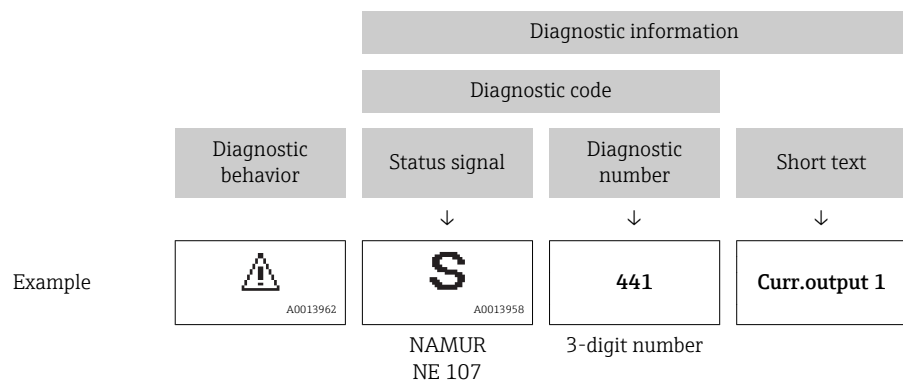

12.5.2 Calling up remedy information

Remedy information is provided for every diagnostic event to ensure that problems can be rectified quickly:

- On the home page
Remedy information is displayed in a separate field below the diagnostics information.
- In the **Diagnostics** menu
Remedy information can be called up in the working area of the user interface.

The user is in the **Diagnostics** menu.

1. Call up the desired parameter.
2. On the right in the working area, mouse over the parameter.
 - ↳ A tool tip with remedy information for the diagnostic event appears.

12.6 Adapting the diagnostic information

12.6.1 Adapting the diagnostic behavior

Each item of diagnostic information is assigned a specific diagnostic behavior at the factory. The user can change this assignment for specific diagnostic information in the **Diagnostic behavior** submenu.

Expert → System → Diagnostic handling → Diagnostic behavior

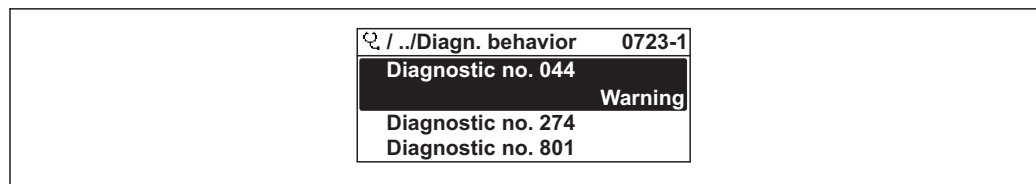

A0014048-EN

39 Taking the example of the local display

You can assign the following options to the diagnostic number as the diagnostic behavior:

Options	Description
Alarm	The device stops measurement. The signal outputs and totalizers assume the defined alarm condition. A diagnostic message is generated. The background lighting changes to red.
Warning	The device continues to measure. The signal outputs and totalizers are not affected. A diagnostic message is generated.
Logbook entry only	The device continues to measure. The diagnostic message is displayed only in the Event logbook submenu (Event list submenu) and is not displayed in alternation with the operational display.
Off	The diagnostic event is ignored, and no diagnostic message is generated or entered.

12.6.2 Adapting the status signal

Each item of diagnostic information is assigned a specific status signal at the factory. The user can change this assignment for specific diagnostic information in the **Diagnostic event category** submenu.

Expert → Communication → Diagnostic event category



Available status signals

Configuration as per HART 7 Specification (Condensed Status), in accordance with NAMUR NE107.

Symbol	Meaning
F <small>A0013956</small>	Failure A device error is present. The measured value is no longer valid.
C <small>A0013959</small>	Function check The device is in service mode (e.g. during a simulation).
S <small>A0013958</small>	Out of specification The device is being operated: <ul style="list-style-type: none"> ▪ Outside its technical specification limits (e.g. outside the process temperature range) ▪ Outside of the configuration carried out by the user (e.g. maximum flow in parameter 20 mA value)
M <small>A0013957</small>	Maintenance required Maintenance is required. The measured value is still valid.
N <small>A0023076</small>	Has no effect on the condensed status.

12.7 Overview of diagnostic information

 The amount of diagnostic information and the number of measured variables affected increase if the measuring device has one or more application packages.

 In the case of some items of diagnostic information, the status signal and the diagnostic behavior can be changed. Change the diagnostic information →  162

Diagnostic number	Short text	Remedy instructions	Status signal [from the factory]	Diagnostic behavior [from the factory]
Diagnostic of sensor				
022	Temperature sensor defective	<ol style="list-style-type: none"> 1. Check or replace sensor electronic module (ISEM) 2. If available: Check connection cable between sensor and transmitter 3. Replace sensor 	F	Alarm
046	Sensor limit exceeded	<ol style="list-style-type: none"> 1. Inspect sensor 2. Check process condition 	S	Alarm ¹⁾
062	Sensor connection faulty	<ol style="list-style-type: none"> 1. Check or replace sensor electronic module (ISEM) 2. If available: Check connection cable between sensor and transmitter 3. Replace sensor 	F	Alarm
063	Exciter current faulty	<ol style="list-style-type: none"> 1. Check or replace sensor electronic module (ISEM) 2. If available: Check connection cable between sensor and transmitter 3. Replace sensor 	S	Alarm
082	Data storage	<ol style="list-style-type: none"> 1. Check module connections 2. Contact service 	F	Alarm

Diagnostic number	Short text	Remedy instructions	Status signal [from the factory]	Diagnostic behavior [from the factory]
083	Memory content	1. Restart device 2. Restore HistoROM S-DAT backup ('Device reset' parameter) 3. Replace HistoROM S-DAT	F	Alarm
140	Sensor signal asymmetrical	1. Check or replace sensor electronic module (ISEM) 2. If available: Check connection cable between sensor and transmitter 3. Replace sensor	S	Alarm ¹⁾
144	Measuring error too high	1. Check or change sensor 2. Check process conditions	F	Alarm ¹⁾
Diagnostic of electronic				
201	Device failure	1. Restart device 2. Contact service	F	Alarm
242	Software incompatible	1. Check software 2. Flash or change main electronics module	F	Alarm
252	Modules incompatible	1. Check electronic modules 2. Change electronic modules	F	Alarm
262	Sensor electronic connection faulty	1. Check or replace connection cable between sensor electronic module (ISEM) and main electronics 2. Check or replace ISEM or main electronics	F	Alarm
270	Main electronic failure	Change main electronic module	F	Alarm
271	Main electronic failure	1. Restart device 2. Change main electronic module	F	Alarm
272	Main electronic failure	1. Restart device 2. Contact service	F	Alarm
273	Main electronic failure	Change electronic	F	Alarm
275	I/O module 1 to n defective	Change I/O module	F	Alarm
276	I/O module 1 to n faulty	1. Restart device 2. Change I/O module	F	Alarm
283	Memory content	1. Reset device 2. Contact service	F	Alarm
302	Device verification active	Device verification active, please wait.	C	Warning
311	Electronic failure	1. Do not reset device 2. Contact service	M	Warning
332	Writing in embedded HistoROM failed	Replace user interface board Ex d/XP: replace transmitter	F	Alarm
361	I/O module 1 to n faulty	1. Restart device 2. Check electronic modules 3. Change I/O Modul or main electronics	F	Alarm
372	Sensor electronic (ISEM) faulty	1. Restart device 2. Check if failure recurs 3. Replace sensor electronic module (ISEM)	F	Alarm
373	Sensor electronic (ISEM) faulty	1. Transfer data or reset device 2. Contact service	F	Alarm

Diagnostic number	Short text	Remedy instructions	Status signal [from the factory]	Diagnostic behavior [from the factory]
374	Sensor electronic (ISEM) faulty	1. Restart device 2. Check if failure recurs 3. Replace sensor electronic module (ISEM)	S	Warning ¹⁾
375	I/O- 1 to n communication failed	1. Restart device 2. Check if failure recurs 3. Replace module rack inclusive electronic modules	F	Alarm
382	Data storage	1. Insert T-DAT 2. Replace T-DAT	F	Alarm
383	Memory content	1. Restart device 2. Delete T-DAT via 'Reset device' parameter 3. Replace T-DAT	F	Alarm
387	Embedded HistoROM failed	Contact service organization	F	Alarm
Diagnostic of configuration				
303	I/O 1 to n configuration changed	1. Apply I/O module configuration (parameter 'Apply I/O configuration') 2. Afterwards reload device description and check wiring	M	Warning
330	Flash file invalid	1. Update firmware of device 2. Restart device	M	Warning
331	Firmware update failed	1. Update firmware of device 2. Restart device	F	Warning
410	Data transfer	1. Check connection 2. Retry data transfer	F	Alarm
412	Processing download	Download active, please wait	C	Warning
431	Trim 1 to n	Carry out trim	C	Warning
437	Configuration incompatible	1. Restart device 2. Contact service	F	Alarm
438	Dataset	1. Check data set file 2. Check device configuration 3. Up- and download new configuration	M	Warning
441	Current output 1 to n	1. Check process 2. Check current output settings	S	Warning ¹⁾
442	Frequency output 1 to n	1. Check process 2. Check frequency output settings	S	Warning ¹⁾
443	Pulse output 1 to n	1. Check process 2. Check pulse output settings	S	Warning ¹⁾
444	Current input 1 to n	1. Check process 2. Check current input settings	S	Warning ¹⁾
453	Flow override	Deactivate flow override	C	Warning
484	Failure mode simulation	Deactivate simulation	C	Alarm
485	Measured variable simulation	Deactivate simulation	C	Warning
486	Current input 1 to n simulation	Deactivate simulation	C	Warning
491	Current output 1 to n simulation	Deactivate simulation	C	Warning

Diagnostic number	Short text	Remedy instructions	Status signal [from the factory]	Diagnostic behavior [from the factory]
492	Simulation frequency output 1 to n	Deactivate simulation frequency output	C	Warning
493	Simulation pulse output 1 to n	Deactivate simulation pulse output	C	Warning
494	Switch output simulation 1 to n	Deactivate simulation switch output	C	Warning
495	Diagnostic event simulation	Deactivate simulation	C	Warning
496	Status input simulation	Deactivate simulation status input	C	Warning
502	CT activation/deactivation failed	Follow the sequence of the custody transfer activation/deactivation: First authorized user login, then set the DIP switch on the main electronic module	C	Warning
520	I/O 1 to n hardware configuration invalid	1. Check I/O hardware configuration 2. Replace wrong I/O module 3. Plug the module of double pulse output on correct slot	F	Alarm
537	Configuration	1. Check IP addresses in network 2. Change IP address	F	Warning
540	Custody transfer mode failed	1. Deactivate custody transfer mode 2. Reactivate custody transfer mode	F	Alarm
543	Double pulse output	1. Check process 2. Check pulse output settings	S	Warning ¹⁾
593	Double pulse output simulation	Deactivate simulation pulse output	C	Warning
594	Relay output simulation	Deactivate simulation switch output	C	Warning
599	Custody transfer logbook full	1. Deactivate custody transfer mode 2. Clear custody transfer logbook (all 30 entries) 3. Activate custody transfer mode	F	Warning
Diagnostic of process				
803	Current loop	1. Check wiring 2. Change I/O module	F	Alarm
830	Sensor temperature too high	Reduce ambient temp. around the sensor housing	S	Warning ¹⁾
831	Sensor temperature too low	Increase ambient temp. around the sensor housing	S	Warning ¹⁾
832	Electronic temperature too high	Reduce ambient temperature	S	Warning ¹⁾
833	Electronic temperature too low	Increase ambient temperature	S	Warning ¹⁾
834	Process temperature too high	Reduce process temperature	S	Warning ¹⁾
835	Process temperature too low	Increase process temperature	S	Warning ¹⁾
842	Process limit	Low flow cut off active! 1. Check low flow cut off configuration	S	Warning
843	Process limit	Check process conditions	S	Alarm





Diagnostic number	Short text	Remedy instructions	Status signal [from the factory]	Diagnostic behavior [from the factory]
862	Partly filled pipe	1. Check for gas in process 2. Adjust detection limits	S	Warning ¹⁾
882	Input signal	1. Check input configuration 2. Check external device or process conditions	F	Alarm
910	Tubes not oscillating	1. Check electronic 2. Inspect sensor	F	Alarm
912	Medium inhomogeneous	1. Check process cond. 2. Increase system pressure	S	Warning ¹⁾
913	Medium unsuitable	1. Check process conditions 2. Check electronic modules or sensor	S	Alarm ¹⁾
944	Monitoring failed	Check process conditions for Heartbeat Monitoring	S	Warning ¹⁾
948	Oscillation damping too high	Check process conditions	S	Warning ¹⁾



1) Diagnostic behavior can be changed.

12.8 Pending diagnostic events

The **Diagnostics** menu allows the user to view the current diagnostic event and the previous diagnostic event separately.





 To call up the measures to rectify a diagnostic event:

- Via local display →  159
- Via Web browser →  160
- Via "FieldCare" operating tool →  162
- Via "DeviceCare" operating tool →  162

 Other pending diagnostic events can be displayed in the **Diagnostic list** submenu →  168

Navigation

"Diagnostics" menu

 Diagnostics	
Actual diagnostics	→  168
Previous diagnostics	→  168
Operating time from restart	→  168
Operating time	→  168

Parameter overview with brief description

Parameter	Prerequisite	Description	User interface
Actual diagnostics	A diagnostic event has occurred.	Shows the current occurred diagnostic event along with its diagnostic information.  If two or more messages occur simultaneously, the message with the highest priority is shown on the display.	Symbol for diagnostic behavior, diagnostic code and short message.
Previous diagnostics	Two diagnostic events have already occurred.	Shows the diagnostic event that occurred prior to the current diagnostic event along with its diagnostic information.	Symbol for diagnostic behavior, diagnostic code and short message.
Operating time from restart	–	Shows the time the device has been in operation since the last device restart.	Days (d), hours (h), minutes (m) and seconds (s)
Operating time	–	Indicates how long the device has been in operation.	Days (d), hours (h), minutes (m) and seconds (s)

12.9 Diagnostic list

Up to 5 currently pending diagnostic events can be displayed in the **Diagnostic list** submenu along with the associated diagnostic information. If more than 5 diagnostic events are pending, the events with the highest priority are shown on the display.

Navigation path



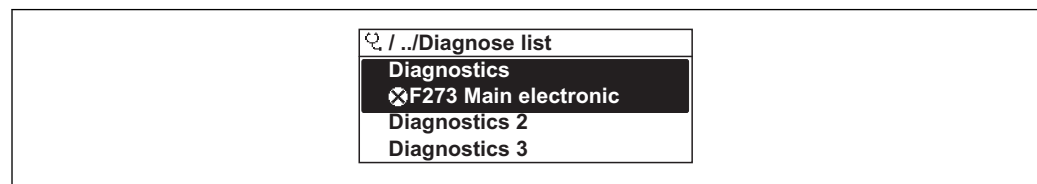

Diagnostics → Diagnostic list



A0014006-EN

 40 Taking the example of the local display

 To call up the measures to rectify a diagnostic event:

- Via local display →  159
- Via Web browser →  160
- Via "FieldCare" operating tool →  162
- Via "DeviceCare" operating tool →  162

12.10 Event logbook

12.10.1 Event history

A chronological overview of the event messages that have occurred is provided in the **Events list** submenu.

Navigation path

Diagnostics menu → **Event logbook** submenu → Event list

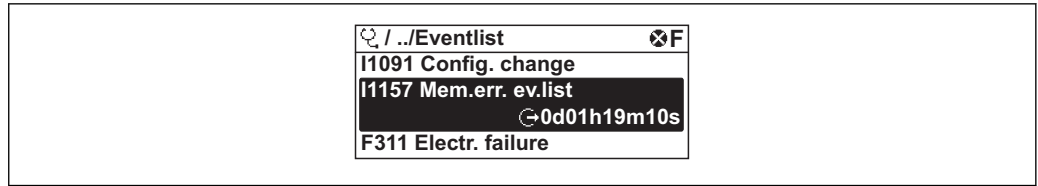

A0014008-EN

41 Taking the example of the local display

- Max. 20 event messages can be displayed in chronological order.
- If the **Extended HistoROM** application package (order option) is enabled in the device, the event list can contain up to 100 entries .

The event history includes entries for:

- Diagnostic events → 163
- Information events → 169

In addition to the operation time of its occurrence, each event is also assigned a symbol that indicates whether the event has occurred or is ended:

- Diagnostic event
 - ⌚: Occurrence of the event
 - ⌚: End of the event
- Information event
 - ⌚: Occurrence of the event

i To call up the measures to rectify a diagnostic event:

- Via local display → 159
- Via Web browser → 160
- Via "FieldCare" operating tool → 162
- Via "DeviceCare" operating tool → 162

i For filtering the displayed event messages → 169

12.10.2 Filtering the event logbook

Using the **Filter options** parameter you can define which category of event message is displayed in the **Events list** submenu.

Navigation path

Diagnostics → Event logbook → Filter options

Filter categories

- All
- Failure (F)
- Function check (C)
- Out of specification (S)
- Maintenance required (M)
- Information (I)

12.10.3 Overview of information events

Unlike a diagnostic event, an information event is displayed in the event logbook only and not in the diagnostic list.

Info number	Info name
I1000	----- (Device ok)
I1079	Sensor changed
I1089	Power on
I1090	Configuration reset
I1091	Configuration changed

Info number	Info name
I1092	Embedded HistoROM deleted
I1111	Density adjust failure
I1137	Electronic changed
I1151	History reset
I1155	Reset electronic temperature
I1156	Memory error trend
I1157	Memory error event list
I1184	Display connected
I1209	Density adjustment ok
I1221	Zero point adjust failure
I1222	Zero point adjustment ok
I1256	Display: access status changed
I1264	Safety sequence aborted
I1278	I/O module reset detected
I1335	Firmware changed
I1361	Web server login failed
I1397	Fieldbus: access status changed
I1398	CDI: access status changed
I1444	Device verification passed
I1445	Device verification failed
I1447	Record application reference data
I1448	Application reference data recorded
I1449	Recording application ref. data failed
I1450	Monitoring off
I1451	Monitoring on
I1457	Measured error verification failed
I1459	I/O module verification failed
I1460	HBSI verification failed
I1461	Sensor verification failed
I1462	Sensor electronic module verif. failed
I1512	Download started
I1513	Download finished
I1514	Upload started
I1515	Upload finished
I1517	Custody transfer active
I1518	Custody transfer inactive
I1554	Safety sequence started
I1555	Safety sequence confirmed
I1556	Safety mode off
I1618	I/O module replaced
I1619	I/O module replaced
I1621	I/O module replaced
I1622	Calibration changed

Info number	Info name
I1624	Reset all totalizers
I1625	Write protection activated
I1626	Write protection deactivated
I1627	Web server login successful
I1628	Display login successful
I1629	CDI login successful
I1631	Web server access changed
I1632	Display login failed
I1633	CDI login failed
I1634	Parameter factory reset
I1635	Parameter delivery reset
I1639	Max. switch cycles number reached
I1643	Custody transfer logbook cleared
I1649	Hardware write protection activated
I1650	Hardware write protection deactivated
I1651	Custody transfer parameter changed
I1712	New flash file received
I1725	Sensor electronic module (ISEM) changed
I1726	Configuration backup failed

12.11 Resetting the measuring device

Using the **Device reset** parameter (→  133) it is possible to reset the entire device configuration or some of the configuration to a defined state.

12.11.1 Function scope of the "Device reset" parameter

Options	Description
Cancel	No action is executed and the user exits the parameter.
To delivery settings	Every parameter for which a customer-specific default setting was ordered is reset to this customer-specific value. All other parameters are reset to the factory setting.
Restart device	The restart resets every parameter whose data are in the volatile memory (RAM) to the factory setting (e.g. measured value data). The device configuration remains unchanged.
Restore S-DAT backup	Restore the data that are saved on the S-DAT. The data record is restored from the electronics memory to the S-DAT.

12.12 Device information

The **Device information** submenu contains all parameters that display different information for device identification.



Navigation

"Diagnostics" menu → Device information

► Device information	
Device tag	→ 172
Serial number	→ 172
Firmware version	→ 172
Device name	→ 172
Order code	→ 172
Extended order code 1	→ 173
Extended order code 2	→ 173
Extended order code 3	→ 173
ENP version	→ 173
Device revision	→ 173
Device ID	→ 173
Device type	→ 173
Manufacturer ID	→ 173



Parameter overview with brief description

Parameter	Description	User interface	Factory setting
Device tag	Shows name of measuring point.	Max. 32 characters, such as letters, numbers or special characters (e.g. @, %, /).	Promass300/500
Serial number	Shows the serial number of the measuring device.	A maximum of 11-digit character string comprising letters and numbers.	–
Firmware version	Shows the device firmware version installed.	Character string in the format xx.yy.zz	–
Device name	Shows the name of the transmitter. The name can be found on the nameplate of the transmitter.	Promass300/500	–
Order code	Shows the device order code. The order code can be found on the nameplate of the sensor and transmitter in the "Order code" field.	Character string composed of letters, numbers and certain punctuation marks (e.g. /).	–

Parameter	Description	User interface	Factory setting
Extended order code 1	Shows the 1st part of the extended order code.  The extended order code can also be found on the nameplate of the sensor and transmitter in the "Ext. ord. cd." field.	Character string	–
Extended order code 2	Shows the 2nd part of the extended order code.  The extended order code can also be found on the nameplate of the sensor and transmitter in the "Ext. ord. cd." field.	Character string	–
Extended order code 3	Shows the 3rd part of the extended order code.  The extended order code can also be found on the nameplate of the sensor and transmitter in the "Ext. ord. cd." field.	Character string	–
ENP version	Shows the version of the electronic nameplate (ENP).	Character string	2.02.00
Device revision	Shows the device revision with which the device is registered with the HART Communication Foundation.	2-digit hexadecimal number	1
Device ID	Shows the device ID for identifying the device in a HART network.	6-digit hexadecimal number	–
Device type	Shows the device type with which the measuring device is registered with the HART Communication Foundation.	2-digit hexadecimal number	0x3B (for Promass 300/500)
Manufacturer ID	Shows the manufacturer ID device is registered with the HART Communication Foundation.	2-digit hexadecimal number	0x11 (for Endress+Hauser)

12.13 Firmware history

Release date	Firmware version	Order code for "Firmware version"	Firmware changes	Documentation type	Documentation
08.2016	01.00.zz	Option 78	Original firmware	Operating Instructions	BA01532D/06/EN/01.16

-  It is possible to flash the firmware to the current version or the previous version using the service interface.
-  For the compatibility of the firmware version with the previous version, the installed device description files and operating tools, observe the information about the device in the "Manufacturer's information" document.
-  The manufacturer's information is available:
 - In the Download Area of the Endress+Hauser web site: www.endress.com → Downloads
 - Specify the following details:
 - Product root, e.g. 8E5B
 - Text search: Manufacturer's information
 - Media type: Documentation – Technical Documentation

13 Maintenance

13.1 Maintenance tasks

No special maintenance work is required.

13.1.1 Exterior cleaning

When cleaning the exterior of measuring devices, always use cleaning agents that do not attack the surface of the housing or the seals.

13.2 Measuring and test equipment

Endress+Hauser offers a wide variety of measuring and test equipment, such as W@M or device tests.

 Your Endress+Hauser Sales Center can provide detailed information on the services.

List of some of the measuring and testing equipment: →  177

13.3 Endress+Hauser services

Endress+Hauser offers a wide variety of services for maintenance such as recalibration, maintenance service or device tests.

 Your Endress+Hauser Sales Center can provide detailed information on the services.

14 Repairs

14.1 General notes

14.1.1 Repair and conversion concept

The Endress+Hauser repair and conversion concept provides for the following:

- The measuring devices have a modular design.
- Spare parts are grouped into logical kits with the associated Installation Instructions.
- Repairs are carried out by Endress+Hauser Service or by appropriately trained customers.
- Certified devices can only be converted to other certified devices by Endress+Hauser Service or at the factory.

14.1.2 Notes for repair and conversion

For repair and modification of a measuring device, observe the following notes:

- ▶ Use only original Endress+Hauser spare parts.
- ▶ Carry out the repair according to the Installation Instructions.
- ▶ Observe the applicable standards, federal/national regulations, Ex documentation (XA) and certificates.
- ▶ Document every repair and each conversion and enter them into the *W@M* life cycle management database.

14.2 Spare parts

W@M Device Viewer (www.endress.com/deviceviewer):

All the spare parts for the measuring device, along with the order code, are listed here and can be ordered. If available, users can also download the associated Installation Instructions.



Measuring device serial number:

- Is located on the nameplate of the device.
- Can be read out via the **Serial number** parameter (→  172) in the **Device information** submenu.

14.3 Endress+Hauser services

Endress+Hauser offers a wide range of services.



Your Endress+Hauser Sales Center can provide detailed information on the services.

14.4 Return

The measuring device must be returned if it is need of repair or a factory calibration, or if the wrong measuring device has been delivered or ordered. Legal specifications require Endress+Hauser, as an ISO-certified company, to follow certain procedures when handling products that are in contact with the medium.

To ensure safe, swift and professional device returns, please refer to the procedure and conditions for returning devices provided on the Endress+Hauser website at

<http://www.endress.com/support/return-material>

14.5 Disposal

14.5.1 Removing the measuring device

1. Switch off the device.

⚠ WARNING

Danger to persons from process conditions.

- ▶ Beware of hazardous process conditions such as pressure in the measuring device, high temperatures or aggressive fluids.

2. Carry out the mounting and connection steps from the "Mounting the measuring device" and "Connecting the measuring device" sections in reverse order. Observe the safety instructions.

14.5.2 Disposing of the measuring device

⚠ WARNING

Danger to personnel and environment from fluids that are hazardous to health.

- ▶ Ensure that the measuring device and all cavities are free of fluid residues that are hazardous to health or the environment, e.g. substances that have permeated into crevices or diffused through plastic.

Observe the following notes during disposal:









- ▶ Observe valid federal/national regulations.
- ▶ Ensure proper separation and reuse of the device components.

15 Accessories

Various accessories, which can be ordered with the device or subsequently from Endress+Hauser, are available for the device. Detailed information on the order code in question is available from your local Endress+Hauser sales center or on the product page of the Endress+Hauser website: www.endress.com.

15.1 Device-specific accessories







15.1.1 For the transmitter

Accessories	Description
Transmitter <ul style="list-style-type: none"> ▪ Proline 500 ▪ Proline 500 – digital 	Transmitter for replacement or storage. Use the order code to define the following specifications: <ul style="list-style-type: none"> ▪ Approvals ▪ Output ▪ Input ▪ Display / operation ▪ Housing ▪ Software <p> For details, see Installation Instructions EA01150</p> <p>For details</p> <ul style="list-style-type: none"> ▪ Proline 500 – digital transmitter: Installation Instructions EA01151 ▪ Proline 500 transmitter: Installation Instructions EA01152 <p> Proline 500 transmitter for replacement: the serial number of the current transmitter should always be quoted when ordering. On the basis of the serial number, the device-specific data of the replacement device can also be used for the new transmitter.</p>
WLAN antenna Wide range	External WLAN antenna for a range of up to 50 m (165 ft).  Further information on the WLAN interface →  82.
Post mounting kit	Post mounting kit for transmitter.  The post mounting kit can only be ordered together with a transmitter.
Protective cover Proline 500	Is used to protect the measuring device from the effects of the weather: e.g. rainwater, excess heating from direct sunlight.  For details, see Installation Instructions EA01160
Display guard Proline 500 – digital	Is used to protect the measuring device from the effects of the weather: e.g. rainwater, excess heating from direct sunlight.  For details, see Installation Instructions EA01161
Connecting cable Proline 500 – digital Sensor – Transmitter	The following cable lengths are available: order code for "Cable, sensor connection" <ul style="list-style-type: none"> ▪ Option B: 20 m (65 ft) ▪ Option E: User configurable up to max. 50 m ▪ Option F: User configurable up to max. 165 ft <p> Maximum possible cable length for a Proline 500 – digital connecting cable: 300 m (1 000 ft)</p>
Connecting cable Proline 500 Sensor – Transmitter	The following cable lengths are available: order code for "Cable, sensor connection" <ul style="list-style-type: none"> ▪ Option 1: 5 m (16 ft) ▪ Option 2: 10 m (32 ft) ▪ Option 3: 20 m (65 ft) <p> Possible cable length for a Proline 500 connecting cable: max. 20 m (65 ft)</p>

15.1.2 For the sensor



Accessories	Description
Heating jacket	Is used to stabilize the temperature of the fluids in the sensor. Water, water vapor and other non-corrosive liquids are permitted for use as fluids. If using oil as a heating medium, please consult with Endress+Hauser.

15.2 Communication-specific accessories





Accessories	Description
Commubox FXA195 HART	For intrinsically safe HART communication with FieldCare via the USB interface.  For details, see "Technical Information" TI00404F
HART Loop Converter HMX50	Is used to evaluate and convert dynamic HART process variables to analog current signals or limit values.  For details, see "Technical Information" TI00429F and Operating Instructions BA00371F
Fieldgate FXA320	Gateway for the remote monitoring of connected 4 to 20 mA measuring devices via a Web browser.  For details, see "Technical Information" TI00025S and Operating Instructions BA00053S
Fieldgate FXA520	Gateway for the remote diagnostics and remote configuration of connected HART measuring devices via a Web browser.  For details, see "Technical Information" TI00025S and Operating Instructions BA00051S
Field Xpert SFX350	Field Xpert SFX350 is a mobile computer for commissioning and maintenance. It enables efficient device configuration and diagnostics for HART and FOUNDATION Fieldbus devices in the non-Ex area .  For details, see Operating Instructions BA01202S
Field Xpert SFX370	Field Xpert SFX370 is a mobile computer for commissioning and maintenance. It enables efficient device configuration and diagnostics for HART and FOUNDATION Fieldbus devices in the non-Ex area and the Ex area .  For details, see Operating Instructions BA01202S

15.3 Service-specific accessories

Accessories	Description
Applicator	Software for selecting and sizing Endress+Hauser measuring devices: <ul style="list-style-type: none"> ▪ Choice of measuring devices for industrial requirements ▪ Calculation of all the necessary data for identifying the optimum flowmeter: e.g. nominal diameter, pressure loss, flow velocity and accuracy. ▪ Graphic illustration of the calculation results ▪ Determination of the partial order code, administration, documentation and access to all project-related data and parameters over the entire life cycle of a project. <p>Applicator is available:</p> <ul style="list-style-type: none"> ▪ Via the Internet: https://wapps.endress.com/applicator ▪ As a downloadable DVD for local PC installation.

W@M	<p>W@M Life Cycle Management</p> <p>Improved productivity with information at your fingertips. Data relevant to a plant and its components is generated from the first stages of planning and during the asset's complete life cycle.</p> <p>W@M Life Cycle Management is an open and flexible information platform with online and on-site tools. Instant access for your staff to current, in-depth data shortens your plant's engineering time, speeds up procurement processes and increases plant uptime.</p> <p>Combined with the right services, W@M Life Cycle Management boosts productivity in every phase. For more information, visit www.endress.com/lifecyclemanagement</p>
FieldCare	<p>FDT-based plant asset management tool from Endress+Hauser.</p> <p>It can configure all smart field units in your system and helps you manage them. By using the status information, it is also a simple but effective way of checking their status and condition.</p> <p> For details, see Operating Instructions BA00027S and BA00059S</p>
DeviceCare	<p>Tool for connecting and configuring Endress+Hauser field devices.</p> <p> For details, see Innovation brochure IN01047S</p>

15.4 System components

Accessories	Description
Memograph M graphic display recorder	<p>The Memograph M graphic display recorder provides information on all relevant measured variables. Measured values are recorded correctly, limit values are monitored and measuring points analyzed. The data are stored in the 256 MB internal memory and also on a SD card or USB stick.</p> <p> For details, see "Technical Information" TI00133R and Operating Instructions BA00247R</p>
Cerabar M	<p>The pressure transmitter for measuring the absolute and gauge pressure of gases, steam and liquids. It can be used to read in the operating pressure value.</p> <p> For details, see "Technical Information" TI00426P, TI00436P and Operating Instructions BA00200P, BA00382P</p>
Cerabar S	<p>The pressure transmitter for measuring the absolute and gauge pressure of gases, steam and liquids. It can be used to read in the operating pressure value.</p> <p> For details, see "Technical Information" TI00383P and Operating Instructions BA00271P</p>
iTEMP	<p>The temperature transmitters can be used in all applications and are suitable for the measurement of gases, steam and liquids. They can be used to read in the fluid temperature.</p> <p> For details, see "Fields of Activity", FA00006T</p>

16 Technical data

16.1 Application

The measuring device is suitable for flow measurement of liquids and gases only.

Depending on the version ordered, the measuring device can also measure potentially explosive, flammable, poisonous and oxidizing media.

To ensure that the device remains in proper operating condition for its service life, use the measuring device only for media against which the process-wetted materials are sufficiently resistant.

16.2 Function and system design

Measuring principle

Mass flow measurement based on the Coriolis measuring principle

Measuring system

The measuring system consists of a transmitter and a sensor. The transmitter and sensor are mounted in physically separate locations. They are interconnected by one connecting cable(s).

For information on the structure of the device →  14

16.3 Input

Measured variable

Direct measured variables

- Mass flow
- Density
- Temperature

Calculated measured variables

- Volume flow
- Corrected volume flow
- Reference density

Measuring range

Measuring ranges for liquids

DN		Measuring range full scale values $\dot{m}_{\min(F)}$ to $\dot{m}_{\max(F)}$	
[mm]	[in]	[kg/h]	[lb/min]
80	3	0 to 180 000	0 to 6 615
100	4	0 to 350 000	0 to 12 860
150	6	0 to 800 000	0 to 29 400

Measuring ranges for gases

The full scale values depend on the density of the gas and can be calculated with the formula below:

$$\dot{m}_{\max(G)} = \dot{m}_{\max(F)} \cdot \rho_G : x$$

$\dot{m}_{\max(G)}$	Maximum full scale value for gas [kg/h]
$\dot{m}_{\max(F)}$	Maximum full scale value for liquid [kg/h]
$\dot{m}_{\max(G)} < \dot{m}_{\max(F)}$	$\dot{m}_{\max(G)}$ can never be greater than $\dot{m}_{\max(F)}$
ρ_G	Gas density in [kg/m ³] at operating conditions
x	Constant dependent on nominal diameter

DN		x
[mm]	[in]	[kg/m ³]
80	3	110
100	4	130
150	6	200

Calculation example for gas

- Sensor: Promass O, DN 80
- Gas: Air with a density of 60.3 kg/m³ (at 20 °C and 50 bar)
- Measuring range (liquid): 180 000 kg/h
- x = 130 kg/m³ (for Promass O, DN 80)

Maximum possible full scale value:

$$\dot{m}_{\max(G)} = \dot{m}_{\max(F)} \cdot \rho_G : x = 180\,000 \text{ kg/h} \cdot 60.3 \text{ kg/m}^3 : 130 \text{ kg/m}^3 = 83\,500 \text{ kg/h}$$

Recommended measuring range

"Flow limit" section →  196

Operable flow range

Over 1000 : 1.



Flow rates above the preset full scale value do not override the electronics unit, with the result that the totalizer values are registered correctly.

Input signal

External measured values

To increase the accuracy of certain measured variables or to calculate the corrected volume flow for gases, the automation system can continuously write different measured values to the measuring device:

- Operating pressure to increase accuracy (Endress+Hauser recommends the use of a pressure measuring device for absolute pressure, e.g. Cerabar M or Cerabar S)
- Fluid temperature to increase accuracy (e.g. iTEMP)
- Reference density for calculating the corrected volume flow for gases

 Various pressure transmitters and temperature measuring devices can be ordered from Endress+Hauser: see "Accessories" section →  179

It is recommended to read in external measured values to calculate the following measured variables for gases:

- Mass flow
- Corrected volume flow

HART protocol

The measured values are written from the automation system to the measuring device via the HART protocol. The pressure transmitter must support the following protocol-specific functions:

- HART protocol
- Burst mode

Current input

The measured values are written from the automation system to the measuring device via the current input →  182.

Current input 0/4 to 20 mA

Current input	0/4 to 20 mA (active/passive)
Current span	<ul style="list-style-type: none"> ■ 4 to 20 mA (active) ■ 0/4 to 20 mA (passive)
Resolution	1 µA
Voltage drop	Typically: 0.6 to 2 V for 3.6 to 22 mA (passive)
Maximum input voltage	≤ 30 V (passive)
Open-circuit voltage	≤ 28.8 V (active)
Possible input variables	<ul style="list-style-type: none"> ■ Pressure ■ Temperature ■ Density

Status input

Maximum input values	<ul style="list-style-type: none"> ■ DC -3 to 30 V ■ If status input is active (ON): $R_i > 3 \text{ k}\Omega$
Response time	Adjustable: 5 to 200 ms

Input signal level	<ul style="list-style-type: none">▪ Low signal: DC -3 to +5 V▪ High signal: DC 12 to 30 V
Assignable functions	<ul style="list-style-type: none">▪ Off▪ Reset the individual totalizers separately▪ Reset all totalizers▪ Flow override

16.4 Output

Output signal

HART current output



Current output	4 to 20 mA HART
Current span	Can be set to: 4 to 20 mA (active/passive)
Open-circuit voltage	DC 28.8 V (active)
Maximum input voltage	DC 30 V (passive)
Load	250 to 700 Ω
Resolution	0.38 μA
Damping	Adjustable: 0.07 to 999 s
Assignable measured variables	<ul style="list-style-type: none"> ▪ Mass flow ▪ Volume flow ▪ Corrected volume flow ▪ Density ▪ Reference density ▪ Temperature <p> The range of options increases if the measuring device has one or more application packages.</p>

Current output 0/4 to 20 mA

Current output	0/4 to 20 mA
Maximum output values	22.5 mA
Current span	Can be set to: <ul style="list-style-type: none"> ▪ 4 to 20 mA (active) ▪ 0/4 to 20 mA (passive)
Open-circuit voltage	DC 28.8 V (active)
Maximum input voltage	DC 30 V (passive)
Load	0 to 700 Ω
Resolution	0.38 μA
Damping	Adjustable: 0.07 to 999 s
Assignable measured variables	<ul style="list-style-type: none"> ▪ Mass flow ▪ Volume flow ▪ Corrected volume flow ▪ Density ▪ Reference density ▪ Temperature <p> The range of options increases if the measuring device has one or more application packages.</p>

Pulse/frequency/switch output

Function	Can be set to pulse, frequency or switch output
Version	Open collector Can be set to: <ul style="list-style-type: none"> ▪ Active ▪ Passive
Maximum input values	DC 30 V, 250 mA (passive)
Open-circuit voltage	DC 28.8 V (active)
Voltage drop	For 22.5 mA: ≤ DC 2 V

Pulse output	
Maximum input values	DC 30 V, 250 mA (passive)
Maximum output current	22.5 mA (active)
Open-circuit voltage	DC 28.8 V (active)
Pulse width	Adjustable: 0.05 to 2 000 ms
Maximum pulse rate	10 000 Impulse/s
Pulse value	Adjustable
Assignable measured variables	<ul style="list-style-type: none"> ▪ Mass flow ▪ Volume flow ▪ Corrected volume flow ▪ Density ▪ Reference density ▪ Temperature
Frequency output	
Maximum input values	DC 30 V, 250 mA (passive)
Maximum output current	22.5 mA (active)
Open-circuit voltage	DC 28.8 V (active)
Output frequency	Adjustable: end value frequency 2 to 10 000 Hz ($f_{\max} = 12\,500$ Hz)
Damping	Adjustable: 0 to 999 s
Pulse/pause ratio	1:1
Assignable measured variables	<ul style="list-style-type: none"> ▪ Mass flow ▪ Volume flow ▪ Corrected volume flow ▪ Density ▪ Reference density ▪ Temperature <p> The range of options increases if the measuring device has one or more application packages.</p>
Switch output	
Maximum input values	DC 30 V, 250 mA (passive)
Open-circuit voltage	DC 28.8 V (active)
Switching behavior	Binary, conductive or non-conductive
Switching delay	Adjustable: 0 to 100 s
Number of switching cycles	Unlimited
Assignable functions	<ul style="list-style-type: none"> ▪ Off ▪ On ▪ Diagnostic behavior ▪ Limit value <ul style="list-style-type: none"> – Mass flow – Volume flow – Corrected volume flow – Density – Reference density – Temperature – Totalizer 1-3 ▪ Flow direction monitoring ▪ Status <ul style="list-style-type: none"> – Partially filled pipe detection – Low flow cut off <p> The range of options increases if the measuring device has one or more application packages.</p>

Double pulse output

Function	Double pulse
Version	Open collector Can be set to: <ul style="list-style-type: none"> ▪ Active ▪ Passive
Maximum input values	DC 30 V, 250 mA (passive)
Open-circuit voltage	DC 28.8 V (active)
Voltage drop	For 22.5 mA: ≤ DC 2 V
Output frequency	Adjustable: 0 to 1 000 Hz
Damping	Adjustable: 0 to 999 s
Pulse/pause ratio	1:1
Assignable measured variables	<ul style="list-style-type: none"> ▪ Mass flow ▪ Volume flow ▪ Corrected volume flow ▪ Density ▪ Reference density ▪ Temperature <p> The range of options increases if the measuring device has one or more application packages.</p>

Relay output

Function	Switch output
Version	Relay output, galvanically isolated
Switching behavior	Can be set to: <ul style="list-style-type: none"> ▪ NO (normally open), factory setting ▪ NC (normally closed)
Maximum switching capacity (passive)	<ul style="list-style-type: none"> ▪ DC 30 V, 0.1 A ▪ AC 30 V, 0.5 A
Assignable functions	<ul style="list-style-type: none"> ▪ Off ▪ On ▪ Diagnostic behavior ▪ Limit value <ul style="list-style-type: none"> - Mass flow - Volume flow - Corrected volume flow - Density - Reference density - Temperature - Totalizer 1-3 ▪ Flow direction monitoring ▪ Status <ul style="list-style-type: none"> - Partially filled pipe detection - Low flow cut off <p> The range of options increases if the measuring device has one or more application packages.</p>

User configurable input/output

One specific input or output is assigned to a user-configurable input/output (configurable I/O) during device commissioning.

The following inputs and outputs are available for assignment:

- Choice of current output: 4 to 20 mA (active), 0/4 to 20 mA (passive)
- Pulse/frequency/switch output
- Choice of current input: 4 to 20 mA (active), 0/4 to 20 mA (passive)
- Status input

The technical values correspond to those of the inputs and outputs described in this section.

Signal on alarm

Depending on the interface, failure information is displayed as follows:

Current output 0/4 to 20 mA

4 to 20 mA

Failure mode	Choose from: <ul style="list-style-type: none"> ■ 4 to 20 mA in accordance with NAMUR recommendation NE 43 ■ 4 to 20 mA in accordance with US ■ Min. value: 3.59 mA ■ Max. value: 22.5 mA ■ Freely definable value between: 3.59 to 22.5 mA ■ Actual value ■ Last valid value
---------------------	--

0 to 20 mA

Failure mode	Choose from: <ul style="list-style-type: none"> ■ Maximum alarm: 22 mA ■ Freely definable value between: 0 to 20.5 mA
---------------------	---

Pulse/frequency/switch output

Pulse output	
Failure mode	Choose from: <ul style="list-style-type: none"> ■ Actual value ■ No pulses
Frequency output	
Failure mode	Choose from: <ul style="list-style-type: none"> ■ Actual value ■ 0 Hz ■ Defined value ($f_{\max} \geq 2$ to 12 500 Hz)
Switch output	
Failure mode	Choose from: <ul style="list-style-type: none"> ■ Current status ■ Open ■ Closed

Relay output

Failure mode	Choose from: <ul style="list-style-type: none"> ■ Current status ■ Open ■ Closed
---------------------	---

Local display

Plain text display	With information on cause and remedial measures
Backlight	Red backlighting indicates a device error.

 Status signal as per NAMUR recommendation NE 107

Interface/protocol

- Via digital communication:
HART protocol
- Via service interface

Plain text display	With information on cause and remedial measures
---------------------------	---

Web server

Plain text display	With information on cause and remedial measures
---------------------------	---

Light emitting diodes (LED)



Status information	<p>Status indicated by various light emitting diodes</p> <p>The following information is displayed depending on the device version:</p> <ul style="list-style-type: none"> ▪ Supply voltage active ▪ Data transmission active ▪ Device alarm/error has occurred <p> Diagnostic information via light emitting diodes</p>
---------------------------	--

Low flow cut off The switch points for low flow cut off are user-selectable.

Galvanic isolation The outputs are galvanically isolated from one another and from earth (PE).

Protocol-specific data

Manufacturer ID	0x11
Device type ID	0x3B
HART protocol revision	7
Device description files (DTM, DD)	Information and files under: www.endress.com
HART load	Min. 250 Ω



<p>Dynamic variables</p>	<p>Read out the dynamic variables: HART command 3 The measured variables can be freely assigned to the dynamic variables.</p> <p>Measured variables for PV (primary dynamic variable)</p> <ul style="list-style-type: none"> ▪ Mass flow ▪ Volume flow ▪ Corrected volume flow ▪ Density ▪ Reference density ▪ Temperature <p>Measured variables for SV, TV, QV (secondary, tertiary and quaternary dynamic variable)</p> <ul style="list-style-type: none"> ▪ Mass flow ▪ Volume flow ▪ Corrected volume flow ▪ Density ▪ Reference density ▪ Temperature ▪ Totalizer 1 ▪ Totalizer 2 ▪ Totalizer 3 <p> The range of options increases if the measuring device has one or more application packages.</p> <p>Heartbeat Technology Application Package Additional measured variables are available with the Heartbeat Technology application package: Oscillation amplitude 0</p> <p> Heartbeat Technology Special Documentation</p>
<p>Device variables</p>	<p>Read out the device variables: HART command 9 The device variables are permanently assigned.</p> <p>A maximum of 8 device variables can be transmitted:</p> <ul style="list-style-type: none"> ▪ 0 = mass flow ▪ 1 = volume flow ▪ 2 = corrected volume flow ▪ 3 = density ▪ 4 = reference density ▪ 5 = temperature ▪ 6 = totalizer 1 ▪ 7 = totalizer 2 ▪ 8 = totalizer 3 ▪ 13 = target mass flow ▪ 14 = carrier mass flow ▪ 15 = concentration

16.5 Power supply





Terminal assignment →  39

Supply voltage	Order code for "Power supply"	terminal voltage		Frequency range
	Option D	DC 24 V	±20%	-
	Option E	AC100 to 240 V	-15...+10%	50/60 Hz
	Option I	DC 24 V	±20%	-
		AC100 to 240 V	-15...+10%	50/60 Hz

Power consumption **Transmitter**
Max. 10 W (active power)

Current consumption	<p>Transmitter</p> <ul style="list-style-type: none"> ■ Max. 400 mA (24 V) ■ Max. 200 mA (110 V, 50/60 Hz; 230 V, 50/60 Hz)
Power supply failure	<ul style="list-style-type: none"> ■ Totalizers stop at the last value measured. ■ Configuration is retained in the plug-in memory (HistoROM DAT). ■ Error messages (incl. total operated hours) are stored.
Electrical connection	→  41
Potential equalization	→  54
Terminals	<p>Transmitter</p> <p>Spring terminals for conductor cross-section 0.2 to 2.5 mm² (24 to 12 AWG)</p>
Cable entries	<ul style="list-style-type: none"> ■ Cable gland: M20 × 1.5 with cable Ø 6 to 12 mm (0.24 to 0.47 in) ■ Thread for cable entry: <ul style="list-style-type: none"> - NPT ½" - G ½" - M20 ■ Device plug for connecting cable: M12 A device plug is always used for the device version with the order code for "Sensor connection housing", option C "Ultra-compact, hygienic, stainless".
Cable specification	→  36

16.6 Performance characteristics

reference operating conditions	<ul style="list-style-type: none"> ■ Error limits based on ISO 11631 ■ Water with +15 to +45 °C (+59 to +113 °F) at 2 to 6 bar (29 to 87 psi) ■ Specifications as per calibration protocol ■ Accuracy based on accredited calibration rigs that are traced to ISO 17025. <p> To obtain measured errors, use the <i>Applicator</i> sizing tool →  178</p>
Maximum measured error	<p>o.r. = of reading; 1 g/cm³ = 1 kg/l; T = medium temperature</p> <p>Base accuracy</p> <p> Design fundamentals →  193</p> <p><i>Mass flow and volume flow (liquids)</i></p> <p>±0.05 % o.r. (PremiumCal; order code for "Calibration flow", option D, for mass flow)</p> <p>±0.10 % o.r.</p> <p><i>Mass flow (gases)</i></p> <p>±0.35 % o.r.</p>

Density (liquids)

Under reference operating conditions [g/cm ³]	Standard density calibration ¹⁾ [g/cm ³]	Wide-range Density specification ^{2) 3)} [g/cm ³]
±0.0005	±0.01	±0.001

- 1) Valid over the entire temperature and density range
- 2) Valid range for special density calibration: 0 to 2 g/cm³, +5 to +80 °C (+41 to +176 °F)
- 3) Order code for "Application package", option EF "Special density"

Temperature

$$\pm 0.5 \text{ °C} \pm 0.005 \cdot T \text{ °C} (\pm 0.9 \text{ °F} \pm 0.003 \cdot (T - 32) \text{ °F})$$

Zero point stability

DN		Zero point stability	
[mm]	[in]	[kg/h]	[lb/min]
80	3	9.0	0.330
100	4	14.0	0.514
150	6	32.0	1.17

Flow values

Flow values as turndown parameter depending on nominal diameter.

SI units

DN [mm]	1:1	1:10	1:20	1:50	1:100	1:500
	[kg/h]	[kg/h]	[kg/h]	[kg/h]	[kg/h]	[kg/h]
80	180 000	18 000	9 000	3 600	1 800	360
100	350 000	35 000	17 500	7 000	3 500	700
150	800 000	80 000	40 000	16 000	8 000	1 600

US units

DN [inch]	1:1	1:10	1:20	1:50	1:100	1:500
	[lb/min]	[lb/min]	[lb/min]	[lb/min]	[lb/min]	[lb/min]
3	6 615	661.5	330.8	132.3	66.15	13.23
4	12 860	1 286	643.0	257.2	128.6	25.72
6	29 400	2 940	1 470	588	294	58.80

Accuracy of outputs

The outputs have the following base accuracy specifications.

Current output

Accuracy	±5 µA
----------	-------

Pulse/frequency output

o.r. = of reading

Accuracy	Max. ± 50 ppm o.r. (across the entire ambient temperature range)
-----------------	--

Repeatability

o.r. = of reading; $1 \text{ g/cm}^3 = 1 \text{ kg/l}$; T = medium temperature

Base repeatability

Mass flow and volume flow (liquids)

± 0.025 % o.r. (PremiumCal, for mass flow)

± 0.05 % o.r.

Mass flow (gases)

± 0.25 % o.r.

 Design fundamentals →  193

Density (liquids)

$\pm 0.00025 \text{ g/cm}^3$

Temperature

$\pm 0.25 \text{ }^\circ\text{C} \pm 0.0025 \cdot T \text{ }^\circ\text{C}$ ($\pm 0.45 \text{ }^\circ\text{F} \pm 0.0015 \cdot (T-32) \text{ }^\circ\text{F}$)

Response time

The response time depends on the configuration (damping).

Influence of ambient temperature

Current output

o.r. = of reading

Temperature coefficient	Max. $1 \mu\text{A}/^\circ\text{C}$
--------------------------------	-------------------------------------

Pulse/frequency output

Temperature coefficient	No additional effect. Included in accuracy.
--------------------------------	---

Influence of medium temperature

Mass flow and volume flow

When there is a difference between the temperature for zero point adjustment and the process temperature, the typical measured error of the sensor is ± 0.0002 % of the full scale value/ $^\circ\text{C}$ (± 0.0001 % of the full scale value/ $^\circ\text{F}$).

Density

When there is a difference between the density calibration temperature and the process temperature, the typical measured error of the sensor is

$\pm 0.00005 \text{ g/cm}^3 \text{ }^\circ\text{C}$ ($\pm 0.000025 \text{ g/cm}^3 \text{ }^\circ\text{F}$). Field density calibration is possible.

Wide-range density specification (special density calibration)

If the process temperature is outside the valid range (\rightarrow  190) the measured error is $\pm 0.00005 \text{ g/cm}^3 \text{ }^\circ\text{C}$ ($\pm 0.000025 \text{ g/cm}^3 \text{ }^\circ\text{F}$)

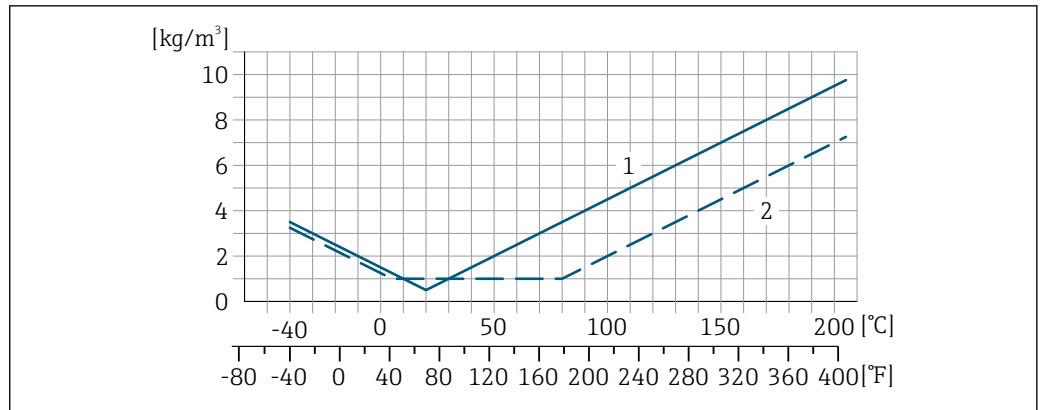

A0016612

- 1 Field density calibration, for example at +20 °C (+68 °F)
- 2 Special density calibration

Temperature

$\pm 0.005 \cdot T \text{ } ^\circ\text{C}$ ($\pm 0.005 \cdot (T - 32) \text{ } ^\circ\text{F}$)

Influence of medium pressure

The table below shows the effect on accuracy of mass flow due to a difference between calibration pressure and process pressure.

o.r. = of reading

DN		[% o.r./bar]	[% o.r./psi]
[mm]	[in]		
80	3	-0.0055	-0.0004
100	4	-0.0035	-0.0002
150	6	-0.002	-0.0001

Design fundamentals

o.r. = of reading, o.f.s. = of full scale value

BaseAccu = base accuracy in % o.r., BaseRepeat = base repeatability in % o.r.

MeasValue = measured value; ZeroPoint = zero point stability

Calculation of the maximum measured error as a function of the flow rate

Flow rate	Maximum measured error in % o.r.
$\geq \frac{\text{ZeroPoint}}{\text{BaseAccu}} \cdot 100$ <small>A0021332</small>	$\pm \text{BaseAccu}$ <small>A0021339</small>
$< \frac{\text{ZeroPoint}}{\text{BaseAccu}} \cdot 100$ <small>A0021333</small>	$\pm \frac{\text{ZeroPoint}}{\text{MeasValue}} \cdot 100$ <small>A0021334</small>

Calculation of the maximum repeatability as a function of the flow rate

Flow rate	Maximum repeatability in % o.r.
$\geq \frac{1/2 \cdot \text{ZeroPoint}}{\text{BaseRepeat}} \cdot 100$ <small>A0021335</small>	$\pm \text{BaseRepeat}$ <small>A0021340</small>
$< \frac{1/2 \cdot \text{ZeroPoint}}{\text{BaseRepeat}} \cdot 100$ <small>A0021336</small>	$\pm 1/2 \cdot \frac{\text{ZeroPoint}}{\text{MeasValue}} \cdot 100$ <small>A0021337</small>

Example for max. measured error

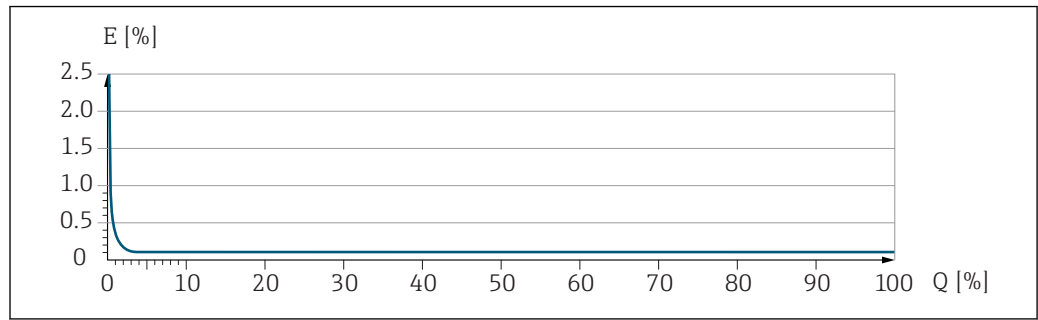

A0030316

E Error: Maximum measured error as % o.r. (example)
 Q Flow rate as %

16.7 Installation

"Mounting requirements" → 22

16.8 Environment

Ambient temperature range → 24

Temperature tables

- Observe the interdependencies between the permitted ambient and fluid temperatures when operating the device in hazardous areas.
- For detailed information on the temperature tables, see the separate document entitled "Safety Instructions" (XA) for the device.

Storage temperature -50 to +80 °C (-58 to +176 °F)

Climate class DIN EN 60068-2-38 (test Z/AD)

Degree of protection **Transmitter**

- As standard: IP66/67, type 4X enclosure
- With the order code for "Sensor options", option **CM**: IP69K can also be ordered
- When housing is open: IP20, type 1 enclosure
- Display module: IP20, type 1 enclosure

Sensor
 As standard: IP66/67, type 4X enclosure

External WLAN antenna
 IP67

Vibration resistance

- Vibration, sinusoidal according to IEC 60068-2-6
 - 2 to 8.4 Hz, 3.5 mm peak
 - 8.4 to 2 000 Hz, 1 g peak
- Vibration broad-band random, according to IEC 60068-2-64
 - 10 to 200 Hz, 0.003 g²/Hz
 - 200 to 2 000 Hz, 0.001 g²/Hz
 - Total: 1.54 g rms

Shock resistance Shock, half-sine according to IEC 60068-2-27
6 ms 30 g

Impact resistance Rough handling shocks according to IEC 60068-2-31

Electromagnetic compatibility (EMC) As per IEC/EN 61326 and NAMUR Recommendation 21 (NE 21)

 For details, refer to the Declaration of Conformity.

16.9 Process

Medium temperature range

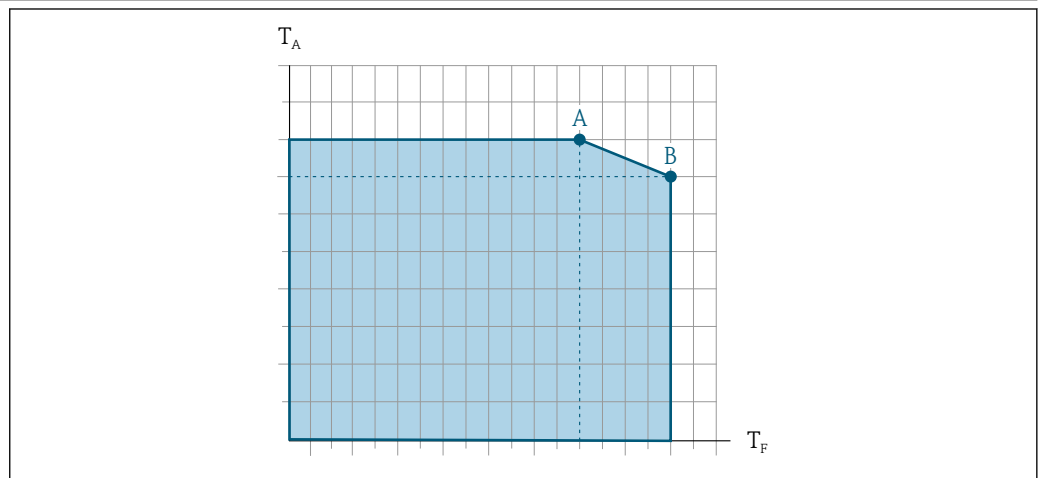

A0031121

T_A Ambient temperature

T_F Medium temperature

A Maximum permitted medium temperature at $T_{A\ max} = 60\text{ °C (140 °F)}$; higher medium temperatures require a reduction in the ambient temperature T_F (derating)

B Maximum permitted ambient temperature at the maximum specified medium temperature of the sensor

Sensor	Noninsulated				Insulated			
	A		B		A		B	
	T_A	T_F	T_A	T_F	T_A	T_F	T_A	T_F
Promass O 500 – digital	60 °C (140 °F)	205 °C (401 °F)	–	–	60 °C (140 °F)	150 °C (302 °F)	55 °C (131 °F)	205 °C (401 °F)

Seals

No internal seals

Density 0 to 5 000 kg/m³ (0 to 312 lb/cf)

Pressure-temperature ratings  An overview of the pressure-temperature ratings for the process connections is provided in the "Technical Information" document

Secondary containment pressure rating The sensor housing is filled with dry inert gas and protects the electronics and mechanics inside.

The following secondary containment pressure rating is only valid for a fully welded sensor housing and/or a device equipped with closed purge connections (never opened/as delivered).

Pressure rating according to ASME BPVC.

DN		Secondary containment pressure rating (designed with a safety factor ≥ 4)		Secondary containment burst pressure	
[mm]	[in]	[bar]	[psi]	[bar]	[psi]
80	3	16	232	95	1378
100	4	16	232	90	1305
150	6	16	232	85	1232

 If there is a risk of the measuring tube breaking due to process characteristics, e.g. in the case of corrosive fluids, we recommend the use of sensors whose secondary containment is equipped with special "pressure monitoring connections" (order code for "Sensor option", option **CH** "purge connection").

With the help of these connections, the fluid collected in the secondary containment can be bled off in the event of tube failure. This is especially important in high-pressure gas applications. These connections can also be used for gas purging (gas detection).

Do not open the purge connections unless the containment can be filled immediately with a dry, inert gas. Use only low gauge pressure to purge. Maximum pressure: 5 bar (72.5 psi).

If a device fitted with purge connections is connected to the purge system, the maximum nominal pressure is determined by the purge system itself or by the device, depending on which component has the lower nominal pressure.

If, on the other hand, the device is fitted with a rupture disk, the rupture disk is decisive for the maximum nominal pressure →  196.

 For information on the dimensions: see the "Mechanical construction" section of the "Technical Information" document

Rupture disk

To increase the level of safety, a device version with a rupture disk with a trigger pressure of 10 to 15 bar (145 to 217.5 psi) can be used (order code for "Sensor option", option **CA** "rupture disk").

Special mounting instructions: →  27

 For information on the dimensions: see the "Mechanical construction" section of the "Technical Information" document



Flow limit

Select the nominal diameter by optimizing between the required flow range and permissible pressure loss.

 For an overview of the full scale values for the measuring range, see the "Measuring range" section

- The minimum recommended full scale value is approx. 1/20 of the maximum full scale value
- In most applications, 20 to 50 % of the maximum full scale value can be considered ideal
- A low full scale value must be selected for abrasive media (such as liquids with entrained solids): flow velocity < 1 m/s (< 3 ft/s).
- For gas measurement the following rules apply:
 - The flow velocity in the measuring tubes should not exceed half the sound velocity (0.5 Mach).
 - The maximum mass flow depends on the density of the gas: formula →  181

Pressure loss

 To calculate the pressure loss, use the *Applicator* sizing tool →  178

System pressure

→  25

16.10 Mechanical construction

Design, dimensions

 For the dimensions and installation lengths of the device, see the "Technical Information" document, "Mechanical construction" section

Weight

Excluding the transmitter

- Aluminum
 - 6.5 kg (14.3 lbs)
 - Digital: 2.4 kg (5.3 lbs)
- Polycarbonate: 1.4 kg (3.1 lbs)
- Cast, stainless: 15.6 kg (34.4 lbs)

Cast connection housing version, stainless: +3.7 kg (+8.2 lbs)

All values (weight) refer to devices with ASME B16.5/Class 900 flanges.

Weight in SI units

DN [mm]	Weight [kg]
80	75
100	141
150	246

Weight in US units

DN [in]	Weight [lbs]
3	165
4	311
6	542

Materials

Transmitter housing

Proline 500 – digital transmitter housing

Order code for "Transmitter housing":

- Option **A** "Aluminum coated": aluminum, AlSi10Mg, coated
- Option **D** "Polycarbonate": polycarbonate

Proline 500 transmitter housing

Order code for "Transmitter housing":

- Option **A** "Aluminum coated": aluminum, AlSi10Mg, coated
- Option **L** "Cast, stainless": cast, stainless steel, 1.4409 (CF3M) similar to 316L

Window material

Order code for "Transmitter housing":

- Option **A** "Aluminum, coated": glass
- Option **D** "Polycarbonate": plastic
- Option **L** "Cast, stainless": glass

Sensor connection housing

Order code for "Sensor connection housing":

- Option **A** "Aluminum coated": aluminum, AlSi10Mg, coated
- Option **B** "Stainless":
 - Stainless steel 1.4301 (304)
 - Optional: Order code for "Sensor feature", option **CC** "Hygienic version, for maximum corrosion resistance": stainless steel, 1.4404 (316L)
- Option **C** "Ultra-compact, stainless":
 - Stainless steel 1.4301 (304)
 - Optional: Order code for "Sensor feature", option **CC** "Hygienic version, for maximum corrosion resistance": stainless steel, 1.4404 (316L)
- Option **L** "Cast, stainless": 1.4409 (CF3M) similar to 316L

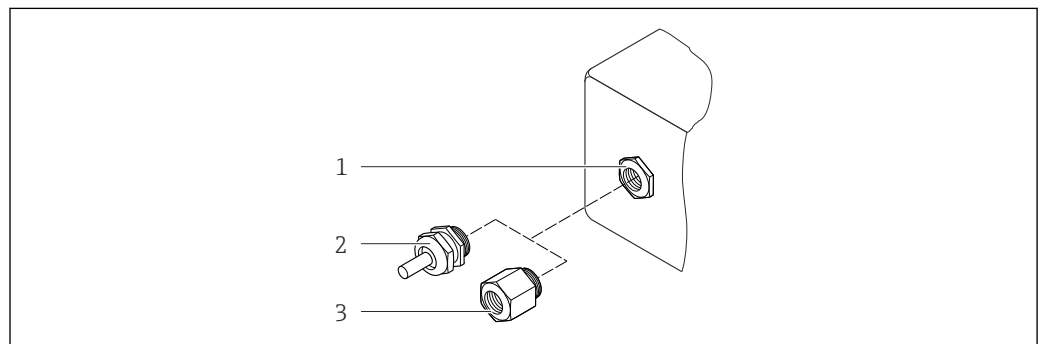

Cable entries/cable glands



A0020640

42 Possible cable entries/cable glands

- 1 Cable entry with M20 × 1.5 internal thread
- 2 Cable gland M20 × 1.5
- 3 Adapter for cable entry with internal thread G ½" or NPT ½"

Cable entries and adapters	Material
Cable gland M20 × 1.5	Plastic
<ul style="list-style-type: none"> ■ Adapter for cable entry with internal thread G ½" ■ Adapter for cable entry with internal thread NPT ½" <p> Only available for certain device versions:</p> <ul style="list-style-type: none"> ■ Order code for "Transmitter housing": <ul style="list-style-type: none"> - Option A "Aluminum, coated" - Option D "Polycarbonate" ■ Order code for "Sensor connection housing": <ul style="list-style-type: none"> - Option A "Aluminum coated" - Proline 500 – digital: <ul style="list-style-type: none"> Option B "Stainless" Option C "Ultra-compact hygienic, stainless" 	Nickel-plated brass
<ul style="list-style-type: none"> ■ Adapter for cable entry with internal thread G ½" ■ Adapter for cable entry with internal thread NPT ½" <p> Only available for certain device versions:</p> <ul style="list-style-type: none"> ■ Order code for "Transmitter housing": <ul style="list-style-type: none"> Option L "Cast, stainless" ■ Order code for "Sensor connection housing": <ul style="list-style-type: none"> Option L "Cast, stainless" 	Stainless steel, 1.4404 (316L)

Connecting cable

Connecting cable for sensor - Proline 500 – digital transmitter

PVC cable with copper shield

Connecting cable for sensor - Proline 500 transmitter

- Standard cable: PVC cable with copper shield
- Reinforced cable: PVC cable with copper shield and additional steel wire braided jacket

Sensor housing

- Acid and alkali-resistant outer surface
- Stainless steel, 1.4404 (316L)

Measuring tubes

Stainless steel, 25Cr Duplex (Super Duplex); 1.4410 (UNS S32750)

Process connections

- Stainless steel, 25Cr Duplex (Super Duplex)
- Stainless steel, 1.4410 (F53)

Seals

Welded process connections without internal seals

Accessories

Protective cover

Stainless steel, 1.4404 (316L)

External WLAN antenna

- WLAN antenna:
 - ASA plastic (acrylic ester-styrene-acrylonitrile) and nickel-plated brass
- Adapter:
 - Stainless steel and copper

Process connections

Fixed flange connections:
 – EN 1092-1 (DIN 2512N) flange
 – ASME B16.5 flange

i For information on the different materials used in the process connections → 199

Surface roughness

All data relate to parts in contact with fluid.
 Not polished

16.11 Operability

Languages

Can be operated in the following languages:

- Via local operation
 English, German, French, Spanish, Italian, Dutch, Portuguese, Polish, Russian, Turkish, Chinese, Japanese, Korean, Arabic, Bahasa (Indonesian), Thai, Vietnamese, Czech, Swedish
- Via Web browser
 English, German, French, Spanish, Italian, Dutch, Portuguese, Polish, Russian, Turkish, Chinese, Japanese, Korean, Arabic, Bahasa (Indonesian), Thai, Vietnamese, Czech, Swedish
- Via "FieldCare", "DeviceCare" operating tool: English, German, French, Spanish, Italian, Chinese, Japanese

Local operation

Via display module

Two display modules are available:

- Order code for "Display; operation", option **F** "4-line, backlit, graphic display; touch control"
- Order code for "Display; operation", option **G** "4-line, backlit, graphic display; touch control + WLAN"

i Information about WLAN interface → 82

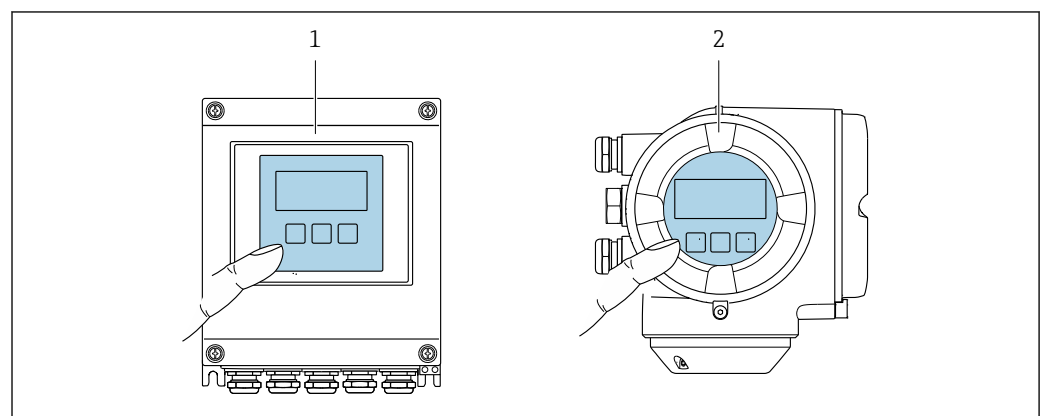

43 Operation with touch control

- 1 Proline 500 – digital
- 2 Proline 500

Display elements

- 4-line, illuminated, graphic display
- White background lighting; switches to red in event of device errors
- Format for displaying measured variables and status variables can be individually configured
- Permitted ambient temperature for the display: -20 to +60 °C (-4 to +140 °F)
The readability of the display may be impaired at temperatures outside the temperature range.



Operating elements

- External operation via touch control (3 optical keys) without opening the housing: ⊕, □, ⊞
- Operating elements also accessible in various hazardous areas

Remote operation →  81

Service interface →  82

Supported operating tools Different operating tools can be used for local or remote access to the measuring device. Depending on the operating tool used, access is possible with different operating units and via a variety of interfaces.

Supported operating tools	Operating unit	Interface	Additional information
Web browser	Notebook, PC or tablet with Web browser	<ul style="list-style-type: none"> ■ CDI-RJ45 service interface ■ WLAN interface 	Special Documentation for the device →  208
DeviceCare SFE100	Notebook, PC or tablet with Microsoft Windows system	<ul style="list-style-type: none"> ■ CDI-RJ45 service interface ■ WLAN interface ■ Fieldbus protocol 	→  178
FieldCare SFE500	Notebook, PC or tablet with Microsoft Windows system	<ul style="list-style-type: none"> ■ CDI-RJ45 service interface ■ WLAN interface ■ Fieldbus protocol 	→  178
Device Xpert	Field Xpert SFX 100/350/370	HART and FOUNDATION Fieldbus fieldbus protocol	Operating Instructions BA01202S Device description files: Use update function of handheld terminal

 Other operating tools based on FDT technology with a device driver such as DTM/ iDTM or DD/EDD can be used for device operation. These operating tools are available from the individual manufacturers. Integration into the following operating tools, among others, is supported:

- Process Device Manager (PDM) by Siemens → www.siemens.com
- Asset Management Solutions (AMS) by Emerson → www.emersonprocess.com
- FieldCommunicator 375/475 by Emerson → www.emersonprocess.com
- Field Device Manager (FDM) by Honeywell → www.honeywellprocess.com
- FieldMate by Yokogawa → www.yokogawa.com
- PACTWare → www.pactware.com

The associated device description files are available at: www.endress.com → Downloads

Web server

Thanks to the integrated Web server, the device can be operated and configured via a Web browser and via a service interface (CDI-RJ45) or a WLAN interface. The structure of the operating menu is the same as for the local display. In addition to the measured values, status information on the device is also displayed and allows the user to monitor the status of the device. Furthermore the measuring device data can be managed and the network parameters can be configured. The WLAN connection requires a device that acts as an access point to enable communication via a computer or mobile handheld terminal.

Supported functions

Data exchange between the operating unit (such as a notebook for example) and the measuring device:

- Uploading the configuration from the measuring device (XML format, configuration backup)
- Save the configuration to the measuring device (XML format, restore configuration)
- Export event list (.csv file)
- Export parameter settings (.csv file, create documentation of the measuring point configuration)
- Export the Heartbeat verification log (PDF file, only available with the "Heartbeat Verification" application package)
- Flash firmware version for device firmware upgrade, for instance

HistoROM data management

The measuring device features HistoROM data management. HistoROM data management comprises both the storage and import/export of key device and process data, making operation and servicing far more reliable, secure and efficient.

 When the device is delivered, the factory settings of the configuration data are stored as a backup in the device memory. This memory can be overwritten with an updated data record, for example after commissioning.

Additional information on the data storage concept

There are different types of data storage units in which device data are stored and used by the device:

	Device memory	T-DAT	S-DAT
Available data	<ul style="list-style-type: none"> ▪ Event history, such as diagnostic events ▪ Parameter data record backup ▪ Device firmware package ▪ Driver for system integration e.g.: DD for HART 	<ul style="list-style-type: none"> ▪ Measured value memory ("Extended HistoROM" order option) ▪ Current parameter data record (used by firmware at run time) ▪ Maximum indicators (min/max values) ▪ Totalizer values 	<ul style="list-style-type: none"> ▪ Sensor data: diameter etc. ▪ Serial number ▪ User-specific access code (to use the "Maintenance" user role) ▪ Calibration data ▪ Device configuration (e.g. SW options, fixed I/O or multi I/O)
Storage location	Fixed on the user interface board in the connection compartment	Can be plugged into the user interface board in the connection compartment	In the sensor plug in the transmitter neck part

Data backup

Automatic

- The most important device data (sensor and transmitter) are automatically saved in the DAT modules
- If the transmitter or measuring device is replaced: once the T-DAT containing the previous device data has been exchanged, the new measuring device is ready for operation again immediately without any errors
- If the sensor is replaced: once the sensor has been replaced, new sensor data are transferred from the S-DAT in the measuring device and the measuring device is ready for operation again immediately without any errors

Manual

Additional parameter data record (complete parameter settings) in the integrated device memory for:

- Data backup function
Backup and subsequent restoration of a device configuration in the device memory
- Data comparison function
Comparison of the current device configuration with the device configuration saved in the device memory

Data transfer**Manual**

Transfer of a device configuration to another device using the export function of the specific operating tool, e.g. with FieldCare, DeviceCare or Web server: to duplicate the configuration or to store in an archive (e.g. for backup purposes)

Event list**Automatic**

- Chronological display of up to 20 event messages in the events list
- If the **Extended HistoROM** application package (order option) is enabled: up to 100 event messages are displayed in the events list along with a time stamp, plain text description and remedial measures
- The events list can be exported and displayed via a variety of interfaces and operating tools e.g. DeviceCare, FieldCare or Web server

Data logging**Manual**

If the **Extended HistoROM** application package (order option) is enabled:

- Record up to 1 000 measured values via 1 to 4 channels
- User configurable recording interval
- Record up to 250 measured values via each of the 4 memory channels
- Export the measured value log via a variety of interfaces and operating tools e.g. FieldCare, DeviceCare or Web server
- Use the recorded measured value data in the integrated device simulation function in the **Diagnostics** submenu (→  167).

Service logbook**Manual**

- Create up to 20 user-specific events with a date and customized text in a separate logbook for documentation of the measuring point
- Use for calibration or service operations, for example, or for maintenance or revision work that has been performed

16.12 Certificates and approvals



CE mark

The measuring system is in conformity with the statutory requirements of the applicable EU Directives. These are listed in the corresponding EU Declaration of Conformity along with the standards applied.

Endress+Hauser confirms successful testing of the device by affixing to it the CE mark.

C-Tick symbol

The measuring system meets the EMC requirements of the "Australian Communications and Media Authority (ACMA)".

Ex approval	<p>The devices are certified for use in hazardous areas and the relevant safety instructions are provided in the separate "Safety Instructions" (XA) document. Reference is made to this document on the nameplate.</p>
Functional safety	<p>The measuring device can be used for flow monitoring systems (min., max., range) up to SIL 2 (single-channel architecture; order code for "Additional approval", option LA) and SIL 3 (multichannel architecture with homogeneous redundancy) and is independently evaluated and certified by the TÜV in accordance with IEC 61508.</p> <p>The following types of monitoring in safety equipment are possible:</p> <ul style="list-style-type: none"> ■ Mass flow ■ Volume flow ■ Density <p> Functional Safety Manual with information on the SIL device →  208</p>
HART certification	<p>HART interface</p> <p>The measuring device is certified and registered by the FieldComm Group. The measuring system meets all the requirements of the following specifications:</p> <ul style="list-style-type: none"> ■ Certified according to HART 7 ■ The device can also be operated with certified devices of other manufacturers (interoperability)
Pressure Equipment Directive	<ul style="list-style-type: none"> ■ With the identification PED/G1/x (x = category) on the sensor nameplate, Endress +Hauser confirms conformity with the "Essential Safety Requirements" specified in Appendix I of the Pressure Equipment Directive 2014/68/EC. ■ Devices not bearing this marking (PED) are designed and manufactured according to good engineering practice. They meet the requirements of Art. 4, Par. 3 of the Pressure Equipment Directive 2014/68/EU. The range of application is indicated in tables 6 to 9 in Annex II of the Pressure Equipment Directive 2014/68/EC.
Radio approval	<p>Europe: RED 2014/53/EU</p> <p>United States of America: CFR Title 47, FCC Part 15.247</p> <p>Canada: RSS-247 Issue 1</p> <p>Japan: Article 2 clause 1 item 19</p> <p> Additional country-specific approvals on request.</p>
Measuring instrument approval	<p>The measuring device is (optionally) approved as a gas meter (MI-002) or component in measuring systems (MI-005) in service subject to legal metrological control in accordance with the European Measuring Instruments Directive 2014/32/EU (MID).</p> <p>The measuring device is qualified to OIML R117 or OIML R137 and has an OIML Certificate of Conformity (optional).</p>
Additional certification	<p>CRN approval</p> <p>Some device versions have CRN approval. A CRN-approved process connection with a CSA approval must be ordered for a CRN-approved device.</p>

Tests and certificates

- Pressure test, internal procedure, inspection certificate
- 3.1 Material certificate, wetted parts and secondary containment, EN10204-3.1 inspection certificate
- PMI test (XRF), internal procedure, wetted parts, EN10204-3.1 inspection certificate
- EN10204-2.1 confirmation of compliance with the order and EN10204-2.2 test report

Testing of welded connections

Option	Test standard				Component	
	ISO 23277-1 (PT) ISO 10675-1 ZG18 (RT, DR)	ASME B31.3	ASME VIII Div.1	NORSOK M-601	Measuring tube	Process connection
CF	x				PT	RT
KK		x			PT	RT
KP			x		PT	RT
KR				x	VT, PT	VT, RT
K1	x				PT	DR
K2		x			PT	DR
K3			x		PT	DR
K4				x	VT, PT	VT, DR

PT = penetrant testing, RT = radiographic testing, VT = visual testing, DR = digital radiography
All options with inspection certificate

Other standards and guidelines

- EN 60529
Degrees of protection provided by enclosures (IP code)
- IEC/EN 60068-2-6
Environmental influences: Test procedure - Test Fc: vibrate (sinusoidal).
- IEC/EN 60068-2-31
Environmental influences: Test procedure - Test Ec: shocks due to rough handling, primarily for devices.
- EN 61010-1
Safety requirements for electrical equipment for measurement, control and laboratory use - general requirements
- IEC/EN 61326
Emission in accordance with Class A requirements. Electromagnetic compatibility (EMC requirements).
- NAMUR NE 21
Electromagnetic compatibility (EMC) of industrial process and laboratory control equipment
- NAMUR NE 32
Data retention in the event of a power failure in field and control instruments with microprocessors
- NAMUR NE 43
Standardization of the signal level for the breakdown information of digital transmitters with analog output signal.
- NAMUR NE 53
Software of field devices and signal-processing devices with digital electronics
- NAMUR NE 80
The application of the pressure equipment directive to process control devices
- NAMUR NE 105
Specifications for integrating fieldbus devices in engineering tools for field devices
- NAMUR NE 107
Self-monitoring and diagnosis of field devices
- NAMUR NE 131
Requirements for field devices for standard applications

- NAMUR NE 132
Coriolis mass meter
- NACE MR0103
Materials resistant to sulfide stress cracking in corrosive petroleum refining environments.
- NACE MR0175/ISO 15156-1
Materials for use in H₂S-containing Environments in Oil and Gas Production.

16.13 Application packages

Many different application packages are available to enhance the functionality of the device. Such packages might be needed to address safety aspects or specific application requirements.

The application packages can be ordered with the device or subsequently from Endress+Hauser. Detailed information on the order code in question is available from your local Endress+Hauser sales center or on the product page of the Endress+Hauser website: www.endress.com.

 Detailed information on the application packages:
Special Documentation for the device

Diagnostics functions

Package	Description
Extended HistoROM	<p>Comprises extended functions concerning the event log and the activation of the measured value memory.</p> <p>Event log: Memory volume is extended from 20 message entries (standard version) to up to 100 entries.</p> <p>Data logging (line recorder):</p> <ul style="list-style-type: none"> ■ Memory capacity for up to 1000 measured values is activated. ■ 250 measured values can be output via each of the 4 memory channels. The recording interval can be defined and configured by the user. ■ Measured value logs can be accessed via the local display or operating tool e.g. FieldCare, DeviceCare or Web server.



Heartbeat Technology

Package	Description
Heartbeat Verification +Monitoring	<p>Heartbeat Monitoring Continuously supplies data, which are characteristic of the measuring principle, to an external condition monitoring system for the purpose of preventive maintenance or process analysis. These data enable the operator to:</p> <ul style="list-style-type: none"> ■ Draw conclusions - using these data and other information - about the impact process influences (such as corrosion, abrasion, buildup etc.) have on the measuring performance over time. ■ Schedule servicing in time. ■ Monitor the process or product quality, e.g. gas pockets. <p>Heartbeat Verification Meets the requirement for traceable verification to DIN ISO 9001:2008 Chapter 7.6 a) "Control of monitoring and measuring equipment".</p> <ul style="list-style-type: none"> ■ Functional testing in the installed state without interrupting the process. ■ Traceable verification results on request, including a report. ■ Simple testing process via local operation or other operating interfaces. ■ Clear measuring point assessment (pass/fail) with high test coverage within the framework of manufacturer specifications. ■ Extension of calibration intervals according to operator's risk assessment.

Concentration

Package	Description
Concentration measurement and special density	<p>Calculation and outputting of fluid concentrations</p> <p>Many applications use density as a key measured value for monitoring quality or controlling processes. The device measures the density of the fluid as standard and makes this value available to the control system.</p> <p>The "Special Density" application package offers high-precision density measurement over a wide density and temperature range particularly for applications subject to varying process conditions.</p> <p>With the help of the "Concentration Measurement" application package, the measured density is used to calculate other process parameters:</p> <ul style="list-style-type: none"> ▪ Temperature-compensated density (reference density). ▪ Percentage mass of the individual substances in a two-phase fluid. (Concentration in %). ▪ Fluid concentration is output with special units (°Brix, °Baumé, °API, etc.) for standard applications.

16.14 Accessories

 Overview of accessories available for order →  177

16.15 Supplementary documentation

 For an overview of the scope of the associated Technical Documentation, refer to the following:

- The *W@M Device Viewer* : Enter the serial number from the nameplate (www.endress.com/deviceviewer)
- The *Endress+Hauser Operations App*: Enter the serial number from the nameplate or scan the 2-D matrix code (QR code) on the nameplate.

Standard documentation

Brief Operating Instructions

Part 1 of 2: Sensor

Measuring device	Documentation code
Proline Promass	KA01212D

Part 2 of 2: Transmitter

Measuring device	Documentation code
Proline 500	KA01230D

Technical Information

Measuring device	Documentation code
Promass O 500	TI01285D

Description of device parameters

Measuring device	Documentation code
Promass 500	GP01060D

Supplementary device-
dependent documentation



Safety Instructions

Contents	Documentation code
	Measuring device
ATEX/IECEX Ex i	XA01473D
ATEX/IECEX Ex ec	XA01474D
cCSAus IS	XA01475D
cCSAus Ex i	XA01509D
cCSAus Ex nA	XA01510D
INMETRO Ex i	XA01476D
INMETRO Ex ec	XA01477D
NEPSI Ex i	XA01478D
NEPSI Ex nA	XA01479D

Special documentation

Contents	Documentation code
Information on the Pressure Equipment Directive	SD01614D
Functional Safety Manual	SD01729D
Web server	SD01666D
Heartbeat Technology	SD01643D
Concentration measurement	SD01645D
Custody transfer	SD01690D

Installation Instructions

Contents	Documentation code
Installation Instructions for spare part sets	 Overview of accessories available for order →  177

Index

A

Access authorization to parameters	
Read access	74
Write access	74
Access code	74
Incorrect input	74
Accuracy	190
Adapting the diagnostic behavior	162
Adapting the status signal	162
Additional certification	204
Ambient temperature range	
Influence	192
AMS Device Manager	86
Function	86
Application	180
Application packages	206
Applicator	181
Approvals	203

B

Burst mode	89
------------	----

C

C-Tick symbol	203
Cable entries	
Technical data	190
Cable entry	
Degree of protection	58
CE mark	11, 203
Certificates	203
Check	
Installation	35
Checklist	
Post-connection check	59
Post-installation check	35
Cleaning	
Exterior cleaning	174
Climate class	194
Commissioning	92
Advanced settings	121
Configuring the measuring device	92
Communication-specific data	87
Connecting cable	36
Connecting the connecting cable	
Proline 500 – digital transmitter	45
Proline 500 terminal assignment	48
Proline 500 transmitter	51
Sensor connection housing, Proline 500	48
Sensor connection housing, Proline 500 - digital	41
Terminal assignment of Proline 500 - digital	41
Connecting the measuring device	
Proline 500	48
Proline 500 – digital	41
Connecting the signal cable/supply voltage cable	
Proline 500 – digital transmitter	46
Proline 500 transmitter	52

Connection

see Electrical connection

Connection preparations	39
Connection tools	36
Context menu	
Calling up	69
Closing	69
Explanation	69
Current consumption	190

D

Declaration of Conformity	11
Define access code	137
Degree of protection	58, 194
Density	195
Design fundamentals	
Maximum measured error	193
Repeatability	193
Designated use	10
Device components	14
Device description files	87
Device documentation	
Supplementary documentation	8
Device locking, status	140
Device name	
Sensor	19
Transmitter	17
Device repair	175
Device revision	87
Device type ID	87
DeviceCare	85
Device description file	87
Diagnostic behavior	
Explanation	158
Symbols	158
Diagnostic information	
Design, description	158, 161
DeviceCare	161
FieldCare	161
Light emitting diodes	153
Local display	157
Overview	163
Remedial measures	163
Web browser	159
Diagnostic list	168
Diagnostic message	157
Diagnostics	
Symbols	157
DIP switches	
see Write protection switch	
Direct access	71
Direct access code	65
Disabling write protection	136
Display	
see Local display	

- Display area
 - For operational display 64
 - In the navigation view 66
- Display values
 - For locking status 140
- Disposal 176
- Document
 - Function 6
 - Symbols used 6
- Document function 6
- Down pipe 23
- E**
- Electrical connection
 - Commubox FXA195 (USB) 81
 - Computer with Web browser (e.g. Internet Explorer) 81
 - Degree of protection 58
 - Field Communicator 475 81
 - Field Xpert SFX350/SFX370 81
 - Measuring device 36
 - Operating tool (e.g. FieldCare, AMS Device Manager, SIMATIC PDM) 81
 - Operating tools
 - Via HART protocol 81
 - Via service interface (CDI-RJ45) 82
 - Via WLAN interface 82
 - VIATOR Bluetooth modem 81
 - Web server 82
 - WLAN interface 82
- Electromagnetic compatibility 195
- Electronics module 14
- Enabling write protection 136
- Endress+Hauser services
 - Maintenance 174
 - Repair 175
- Environment
 - Impact resistance 195
 - Shock resistance 195
 - Storage temperature 194
 - Vibration resistance 194
- Error messages
 - see Diagnostic messages
- Event history 168
- Event list 168
- Ex approval 204
- Extended order code
 - Sensor 19
 - Transmitter 17
- Exterior cleaning 174
- F**
- Field Communicator
 - Function 86
- Field Communicator 475 86
- Field of application
 - Residual risks 11
- Field Xpert
 - Function 84
- Field Xpert SFX350 84
- FieldCare 84
 - Device description file 87
 - Establishing a connection 84
 - Function 84
 - User interface 85
- Filtering the event logbook 169
- Firmware
 - Release date 87
 - Version 87
- Firmware history 173
- Flow direction 23, 30
- Flow limit 196
- Function check 92
- Function scope
 - AMS Device Manager 86
 - Field Communicator 86
 - Field Communicator 475 86
 - Field Xpert 84
 - SIMATIC PDM 86
- Functional safety (SIL) 204
- Functions 92
- G**
- Galvanic isolation 188
- H**
- Hardware write protection 138
- HART certification 204
- HART protocol
 - Device variables 87
 - Measured variables 87
- Help text
 - Calling up 72
 - Closing 72
 - Explanation 72
- HistoROM 130
- I**
- Identifying the measuring device 17
- Impact resistance 195
- Incoming acceptance 16
- Influence
 - Ambient temperature range 192
 - Medium pressure 193
 - Medium temperature 192
- Information on the document 6
- Inlet runs 24
- Input 181
- Input mask 67
- Inspection
 - Received goods 16
- Inspection check
 - Connection 59
- Installation 22
- Installation conditions
 - Down pipe 23
 - Inlet and outlet runs 24
 - Mounting location 22

- Orientation 23
- Rupture disk 27
- Sensor heating 26
- System pressure 25
- Thermal insulation 25
- Vibrations 27
- Installation dimensions 24
- K**
- Keypad lock
 - Disabling 74
 - Enabling 74
- L**
- Languages, operation options 200
- Line recorder 148
- Local display 200
 - Editing view 67
 - Navigation view 65
 - see Diagnostic message
 - see In alarm condition
 - see Operational display
- Low flow cut off 188
- M**
- Main electronics module 14
- Maintenance tasks 174
- Managing the device configuration 130
- Manufacturer ID 87
- Manufacturing date 17, 19
- Materials 198
- Maximum measured error 190
- Measured values
 - see Process variables
- Measuring and test equipment 174
- Measuring device
 - Configuration 92
 - Conversion 175
 - Disposal 176
 - Mounting the sensor 30
 - Preparing for electrical connection 39
 - Preparing for mounting 30
 - Removing 176
 - Repairs 175
 - Structure 14
 - Switch-on 92
- Measuring instrument approval 204
- Measuring principle 180
- Measuring range
 - Calculation example for gas 181
 - For gases 181
 - For liquids 181
- Measuring range, recommended 196
- Measuring system 180
- Medium pressure
 - Influence 193
- Medium temperature
 - Influence 192
- Menu
 - Diagnostics 167
 - Setup 94
- Menus
 - For measuring device configuration 92
 - For specific settings 121
- Mounting dimensions
 - see Installation dimensions
- Mounting location 22
- Mounting preparations 30
- Mounting requirements
 - Installation dimensions 24
- Mounting tools 30
- N**
- Nameplate
 - Sensor 19
 - Transmitter 17
- Navigation path (navigation view) 65
- Navigation view
 - In the submenu 65
 - In the wizard 65
- Nominal pressure
 - Secondary containment 195
- Numeric editor 67
- O**
- Operable flow range 182
- Operating elements 68, 158
- Operating keys
 - see Operating elements
- Operating menu
 - Menus, submenus 61
 - Structure 61
 - Submenus and user roles 62
- Operating philosophy 62
- Operation 140
- Operation options 60
- Operational display 63
- Operational safety 11
- Order code 17, 19
- Orientation (vertical, horizontal) 23
- Outlet runs 24
- Output 184
- Output signal 184
- P**
- Packaging disposal 22
- Parameter settings
 - Administration (Submenu) 133
 - Advanced setup (Submenu) 122
 - Burst configuration 1 to n (Submenu) 89
 - Calculated values (Submenu) 122
 - Configuration backup (Submenu) 130
 - Current input 99
 - Current input (Wizard) 99
 - Current input 1 to n (Submenu) 143
 - Current output 101
 - Current output (Wizard) 101

- Data logging (Submenu) 148
- Define access code (Wizard) 132
- Device information (Submenu) 171
- Diagnostics (Menu) 167
- Display (Submenu) 126
- Display (Wizard) 116
- Double pulse output 115
- Double pulse output (Submenu) 115, 146
- I/O configuration 98
- I/O configuration (Submenu) 98
- Low flow cut off (Wizard) 119
- Measured variables (Submenu) 141
- Partially filled pipe detection (Wizard) 120
- Pulse/frequency/switch output 104
- Pulse/frequency/switch output (Wizard) 104,
106, 111
- Pulse/frequency/switch output 1 to n (Submenu) 145
- Relay output 113
- Relay output 1 to n (Submenu) 146
- Relay output 1 to n (Wizard) 113
- Reset access code (Submenu) 133
- Select medium (Wizard) 97
- Sensor adjustment (Submenu) 123
- Setup (Menu) 94
- Simulation (Submenu) 133
- Status input 100
- Status input (Submenu) 100
- Status input 1 to n (Submenu) 144
- System units (Submenu) 94
- Totalizer (Submenu) 142
- Totalizer 1 to n (Submenu) 124
- Totalizer handling (Submenu) 147
- Value current output 1 to n (Submenu) 144
- Web server (Submenu) 80
- WLAN Settings (Submenu) 129
- Zero point adjustment (Submenu) 124
- Parameters
 - Changing 73
 - Enter a value 73
- Performance characteristics 190
- Post-connection check (checklist) 59
- Post-installation check 92
- Post-installation check (checklist) 35
- Potential equalization 54
- Power consumption 189
- Power supply failure 190
- Pressure Equipment Directive 204
- Pressure loss 197
- Pressure-temperature ratings 195
- Process connections 200
- Process variables
 - Calculated 181
 - Measured 181
- Product safety 11
- Proline 500 – digital transmitter
 - Connecting the signal cable/supply voltage cable . . 46
- Proline 500 connecting cable terminal assignment
 - Sensor connection housing 48
- Proline 500 transmitter
 - Connecting the signal cable/supply voltage cable . . 52
 - Protecting parameter settings 136
- R**
- Radio approval 204
- Read access 74
- Reading measured values 140
- Recalibration 174
- reference operating conditions 190
- Registered trademarks 9
- Remedial measures
 - Calling up 159
 - Closing 159
- Remote operation 201
- Repair of a device 175
- Repairs 175
 - Notes 175
- Repeatability 192
- Replacement
 - Device components 175
- Requirements for personnel 10
- Response time 192
- Return 175
- Rupture disk
 - Safety instructions 27
 - Triggering pressure 196
- S**
- Safety 10
- Seals
 - Medium temperature range 195
- Sensor
 - Mounting 30
- Sensor heating 26
- Serial number 17, 19
- Setting the operating language 92
- Settings
 - Adapting the measuring device to the process
 - conditions 147
 - Administration 132
 - Advanced display configurations 126
 - Current input 99
 - Current output 101
 - Device reset 171
 - Device tag 94
 - Double pulse output 115
 - I/O configuration 98
 - Local display 116
 - Low flow cut off 119
 - Managing the device configuration 130
 - Medium 97
 - Operating language 92
 - Partial filled pipe detection 120
 - Pulse output 104
 - Pulse/frequency/switch output 104, 106
 - Relay output 113
 - Resetting the totalizer 147
 - Sensor adjustment 123

- Simulation 133
- Status input 100
- Switch output 111
- System units 94
- Totalizer 124
- Totalizer reset 147
- WLAN 129
- Shock resistance 195
- Showing data logging 148
- Signal on alarm 187
- SIL (functional safety) 204
- SIMATIC PDM 86
 - Function 86
- Software release 87
- Spare part 175
- Spare parts 175
- Special connection instructions 54
- Standards and guidelines 205
- Status area
 - For operational display 63
 - In the navigation view 65
- Status signals 157, 160
- Storage conditions 21
- Storage temperature 21
- Storage temperature range 194
- Structure
 - Measuring device 14
 - Operating menu 61
- Submenu
 - Administration 132, 133
 - Advanced setup 121, 122
 - Burst configuration 1 to n 89
 - Calculated values 122
 - Configuration backup 130
 - Current input 1 to n 143
 - Data logging 148
 - Device information 171
 - Display 126
 - Double pulse output 115, 146
 - Event list 168
 - I/O configuration 98
 - Input values 143
 - Measured values 140
 - Measured variables 141
 - Output values 144
 - Overview 62
 - Process variables 122
 - Pulse/frequency/switch output 1 to n 145
 - Relay output 1 to n 146
 - Reset access code 133
 - Sensor adjustment 123
 - Simulation 133
 - Status input 100
 - Status input 1 to n 144
 - System units 94
 - Totalizer 142
 - Totalizer 1 to n 124
 - Totalizer handling 147
 - Value current output 1 to n 144
 - Web server 80
 - WLAN Settings 129
 - Zero point adjustment 124

Supply voltage 189

Surface roughness 200

Switch output 186

Symbols

 - For communication 63
 - For correction 67
 - For diagnostic behavior 63
 - For locking 63
 - For measured variable 64
 - For measurement channel number 64
 - For menus 66
 - For parameters 66
 - For status signal 63
 - For submenu 66
 - For wizard 66
 - In the status area of the local display 63
 - In the text and numeric editor 67

System design

 - Measuring system 180
 - see Measuring device design

System integration 87

System pressure 25

T

Technical data, overview 180

Temperature range

 - Ambient temperature range for display 200
 - Medium temperature 195
 - Storage temperature 21

Terminal assignment 39

Terminal assignment of connecting cable for Proline 500- digital

 - Sensor connection housing 41

terminals 190

Tests and certificates 205

Text editor 67

Thermal insulation 25

Tool tip

 - see Help text

Tools

 - Electrical connection 36
 - Installation 30
 - Transport 21

Totalizer

 - Configuration 124

Transmitter

 - Turning the display module 34
 - Turning the housing 33

Transporting the measuring device 21

Troubleshooting

 - General 151

Turning the display module 34

Turning the electronics housing

 - see Turning the transmitter housing

Turning the transmitter housing 33

U

- Use of the measuring device
 - Borderline cases 10
 - Incorrect use 10
 - see Designated use
- User interface
 - Current diagnostic event 167
 - Previous diagnostic event 167
- User roles 62

V

- Version data for the device 87
- Vibration resistance 194
- Vibrations 27

W

- W@M 174, 175
- W@M Device Viewer 17, 175
- Weight
 - SI units 197
 - Transport (notes) 21
 - US units 197
- Wizard
 - Current input 99
 - Current output 101
 - Define access code 132
 - Display 116
 - Low flow cut off 119
 - Partially filled pipe detection 120
 - Pulse/frequency/switch output 104, 106, 111
 - Relay output 1 to n 113
 - Select medium 97
- WLAN settings 129
- Workplace safety 11
- Write access 74
- Write protection
 - Via access code 136
 - Via write protection switch 138
- Write protection switch 138

www.addresses.endress.com
